

A	B	C1	C2	C3	D
1	M232-0007	348	496	16	1/1
2	M232-1007	320	367	16	1/1
3	M232-1008	320	367	16	1/1
4	M232-1009	320,	347	16	1/1
5	M232-2001	801	368	16	1/1
6	M232-2002	801	367	16	1/1
7	M232-3001	475,	347	16	1/1
8	M232-3002	275	347	16	1/1
9	M232-5301	790	360	55	1/1
10	M232-9005	330	778	2,5	1/1

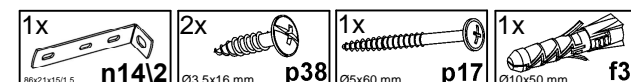

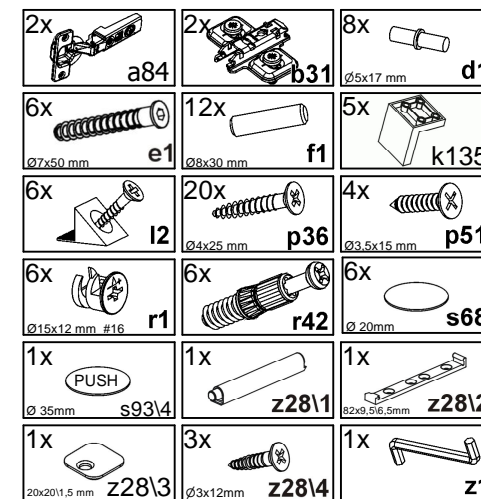

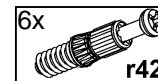
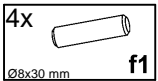
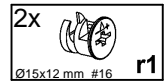
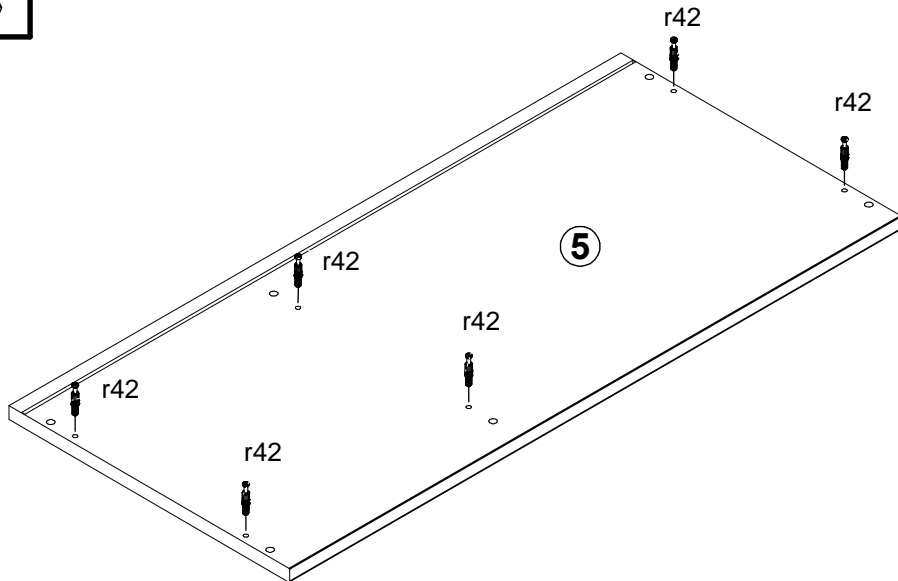
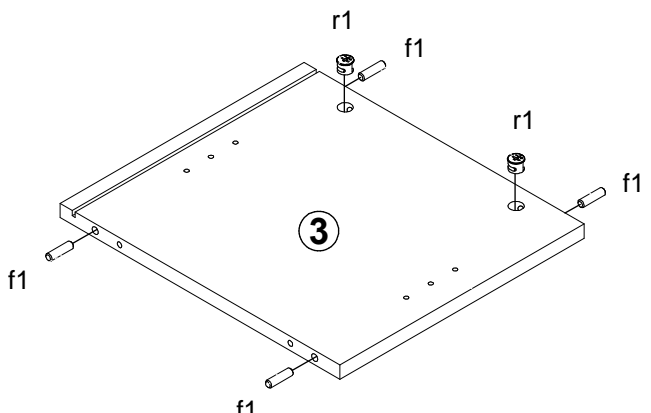
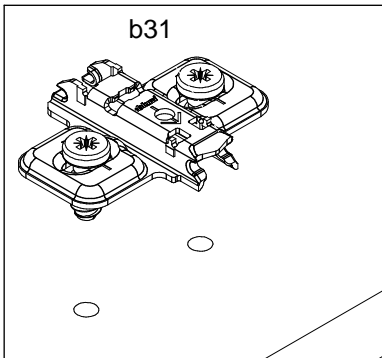
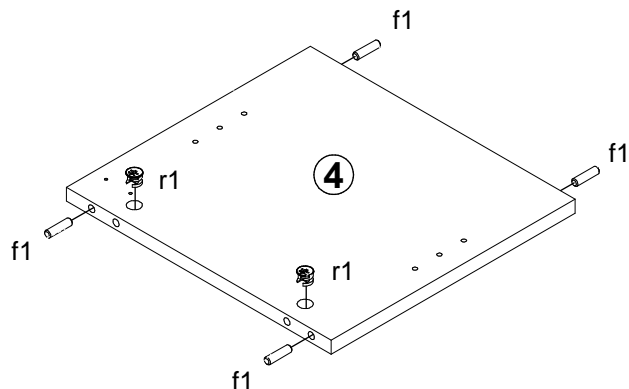
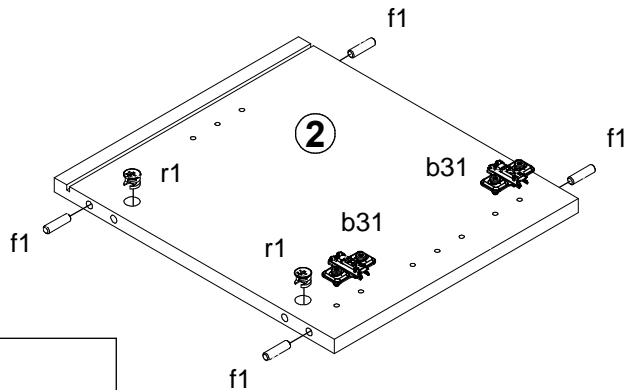
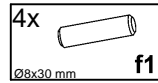
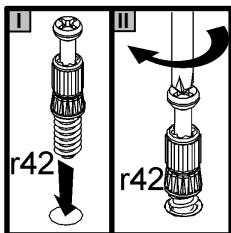
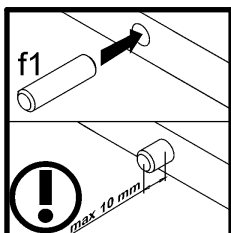
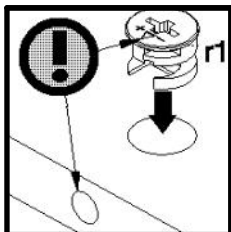
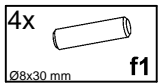
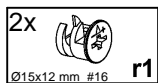
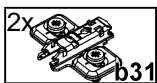
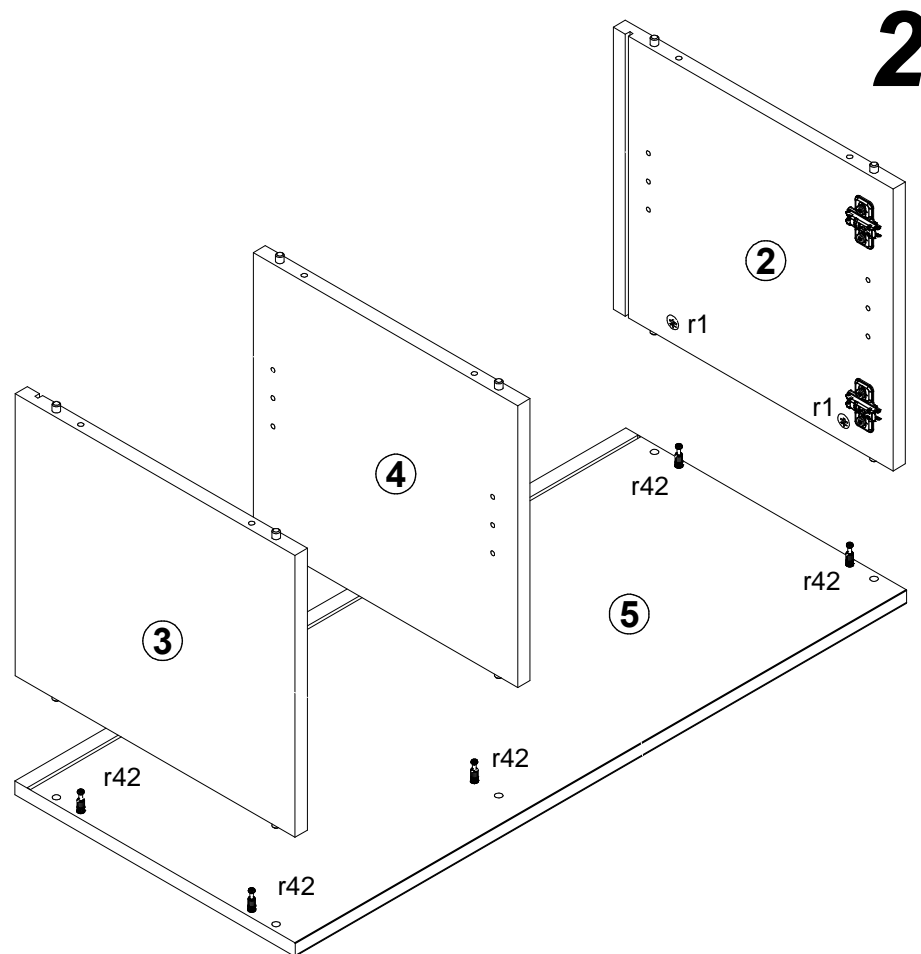

2

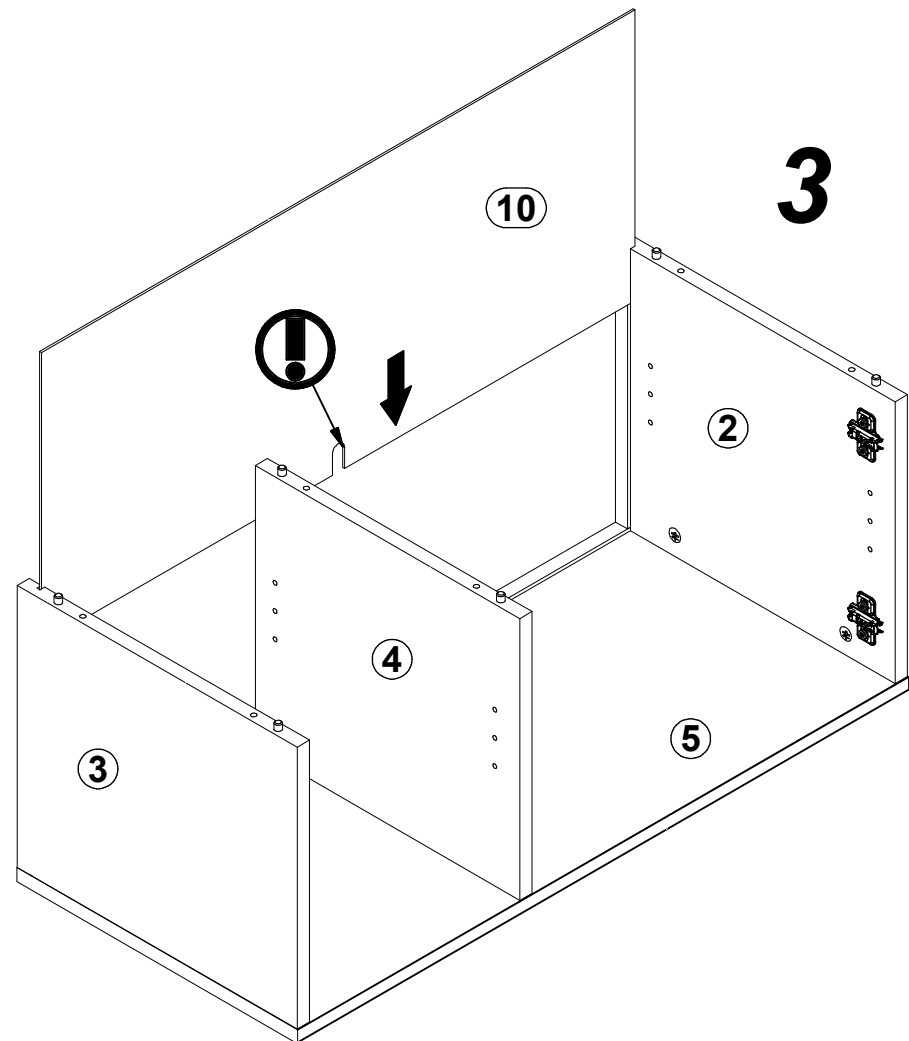

3

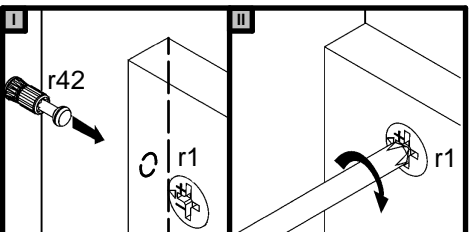

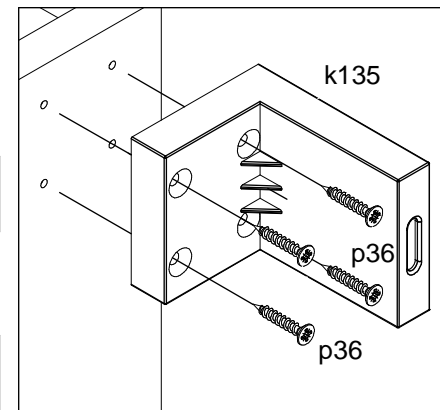
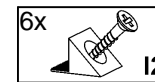
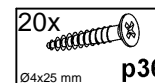
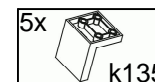
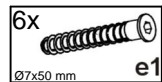
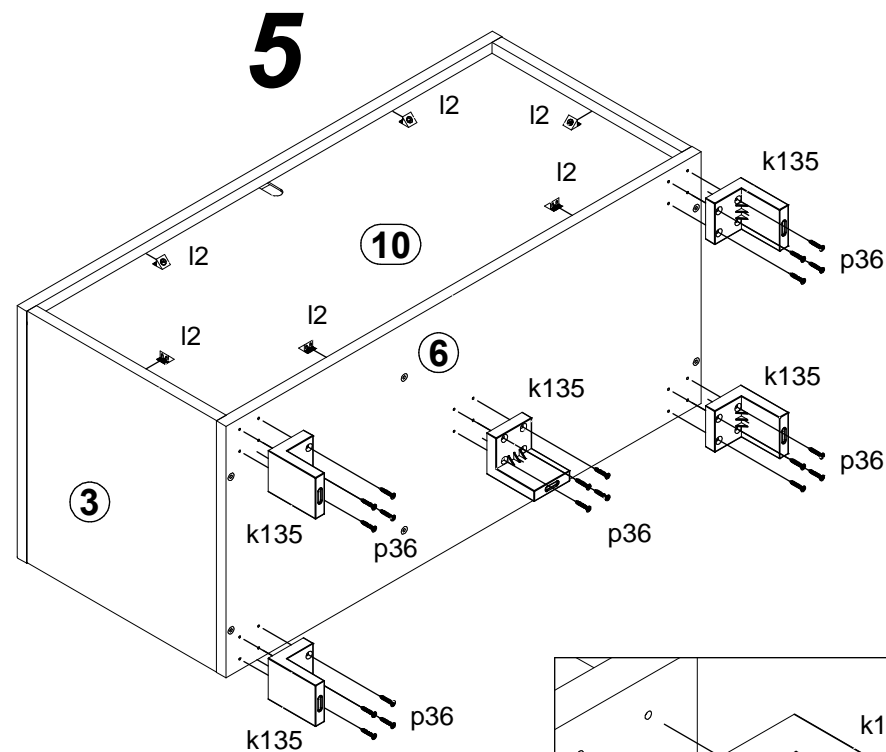
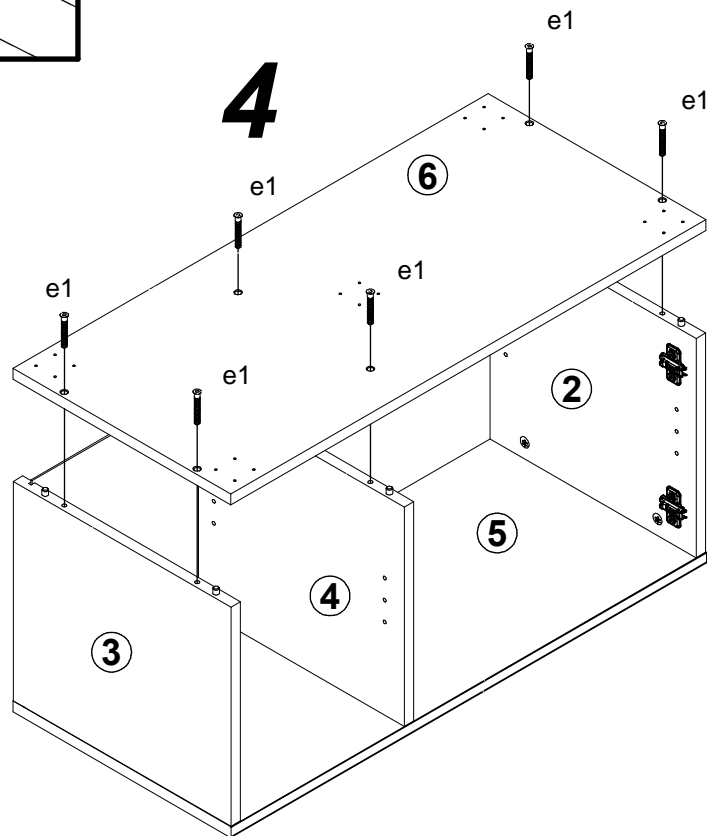
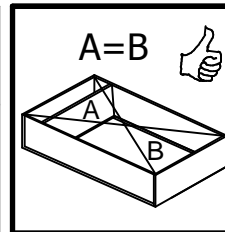
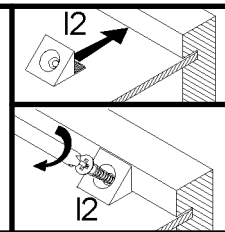
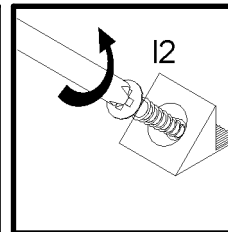
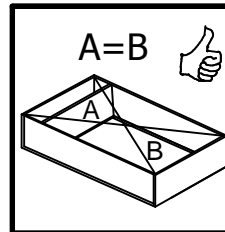
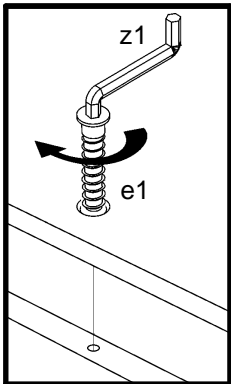

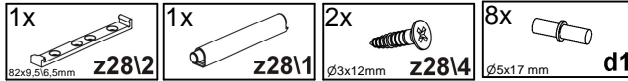
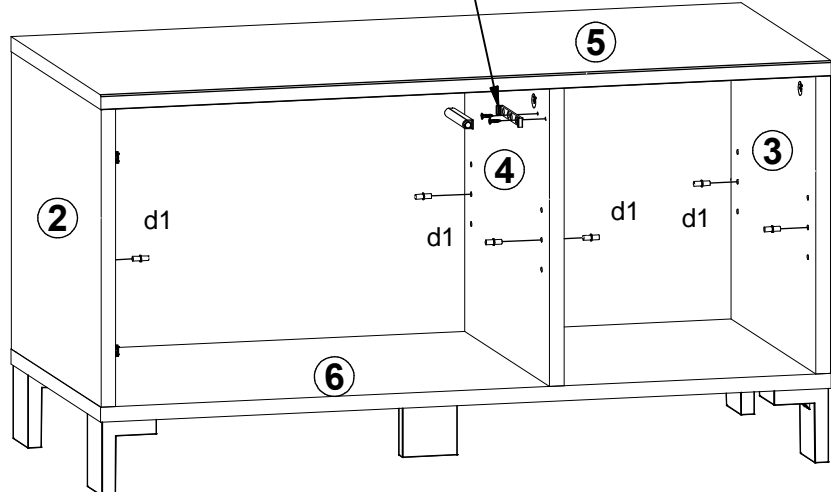
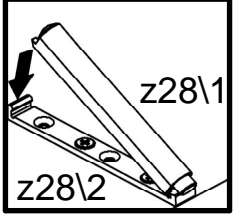
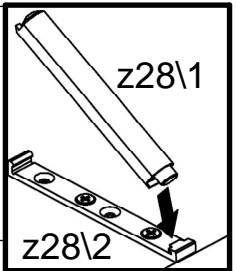
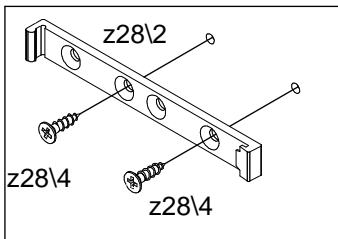
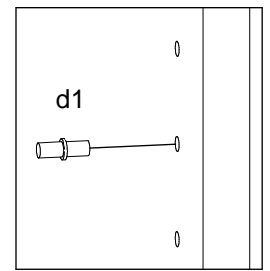

7

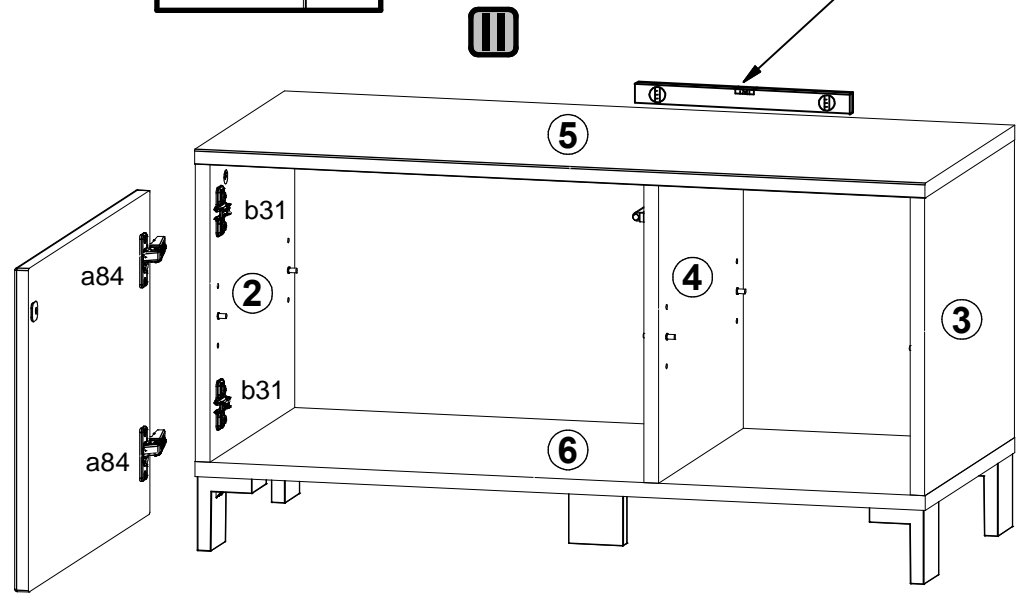
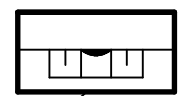
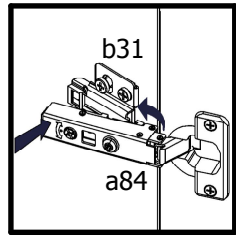
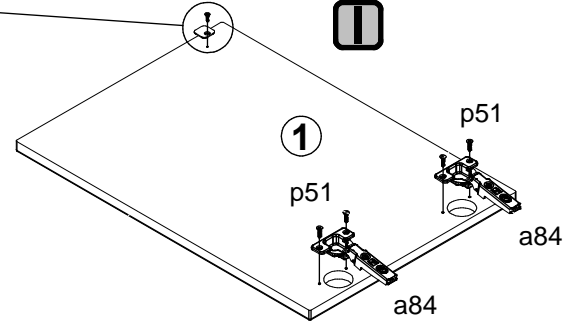
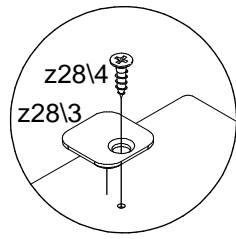
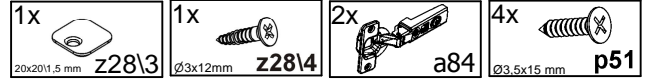

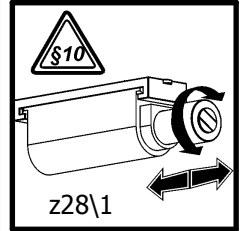
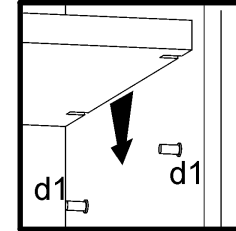
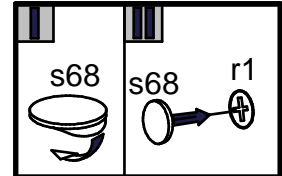
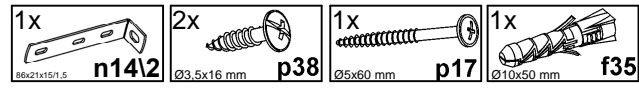
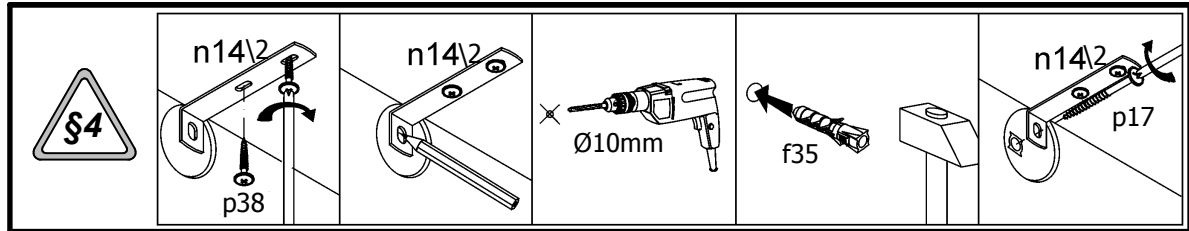

8

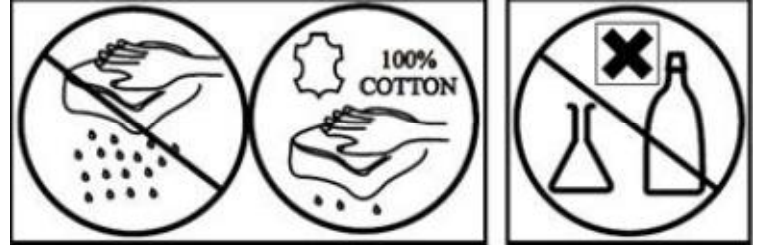
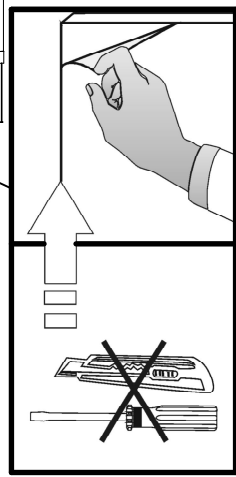
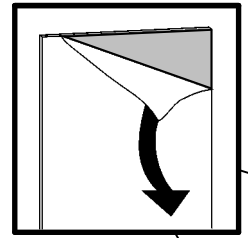
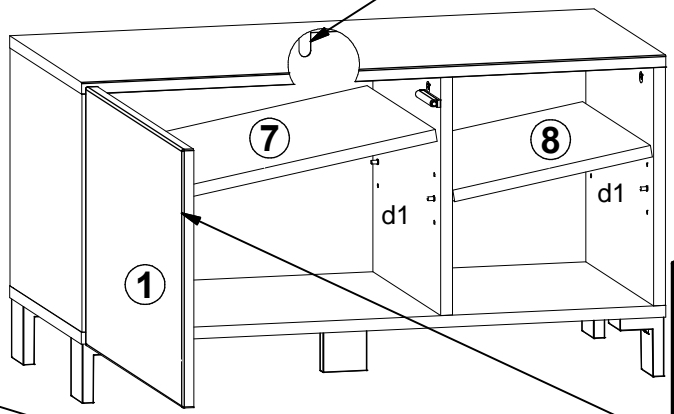

9

