

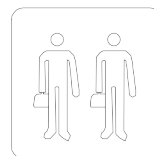

# WESTMANN

## MONTAGEANLEITUNG

### Mülltonnenbox - 3er

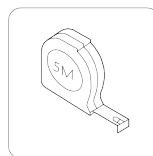
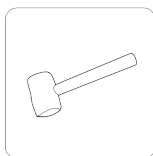
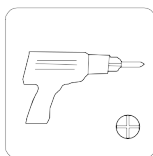

**BEI FRAGEN, KONTAKTIEREN SIE  
UNSEREN KUNDENSERVICE:**

50NRTH GmbH  
Straßburgstraße 14-16  
D-54516 Wittlich

service@50NRTH.com  
+49 (0) 6571 95117-0

# Vorbereitung

## **WICHTIG:**

Bitte erkunden Sie sich bei Ihrem Bauamt vor Ort, ob Sie eine Baugenehmigung benötigen!

## **Aufbauhinweise:**

Lesen Sie im Vorfeld die Anleitung ordnungsgemäß durch und montieren Sie das Produkt sorgfältig und gewissenhaft.

## **Fundament:**

Das Produkt muss auf einem bestehenden Fundament verschraubt (Dübel und Schrauben nicht mitgeliefert) werden. Wir empfehlen ein Betonfundament mit einem Drainage als Ablauf.

Zwischen Fundament und Unterkonstruktion raten wir eine Plastikplane zu befestigen. Diese vermindert die Bildung von Kondenswasser. Die Verankerung bietet gleichzeitig einen Schutz gegen Wind. Dichten Sie nach Aufbau die Unterkonstruktion und das Fundament mit Silikon ab.

## **Teile:**

Vor Beginn der Montage, sortieren und identifizieren Sie alle Teile und gleichen diese mit der mitgelieferten Teileliste ab.

Bei Fehlteilen kontaktieren Sie bitte Ihren Vertragspartner.

## **Benötigtes Werkzeug:**

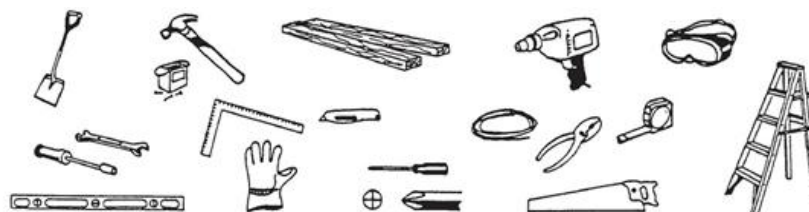

## **Sicherheitshinweise:**

1. Montieren Sie die Ware an einem trockenen Tag. Für den Aufbau benötigen Sie 2 Personen.
2. Tragen Sie Handschuhe, eine Schutzbrille und lange Kleidung um Verletzungen vorzubeugen.  
ACHTUNG: Manche Teile haben scharfe Kanten.
3. Lassen Sie keine Kinder und Tiere in die Nähe des Aufbauplatzes.
4. Legen Sie sich mit Ihrem Gewicht nicht auf die Konstruktionen.  
Bei Nutzung einer Leiter gewähren Sie bitte einen sicheren Stand

## **Pflegehinweise:**

1. Verwenden Sie zur Reinigung nur mildes Reinigungsmittel.
2. Reinigen Sie die Türschieben gelegentlich um eine saubere Öffnung der Türe zu gewährleisten.
3. Befreien Sie das Dach trotz der Schneelastangabe im Winter von Schnee und Eis.
4. Das Gerätehaus dient zur Aufbewahrung von diversen Gartenartikeln.
5. Tropfen Sie ein wenig Öl auf die Türschieben damit diese leichtgängig sind.

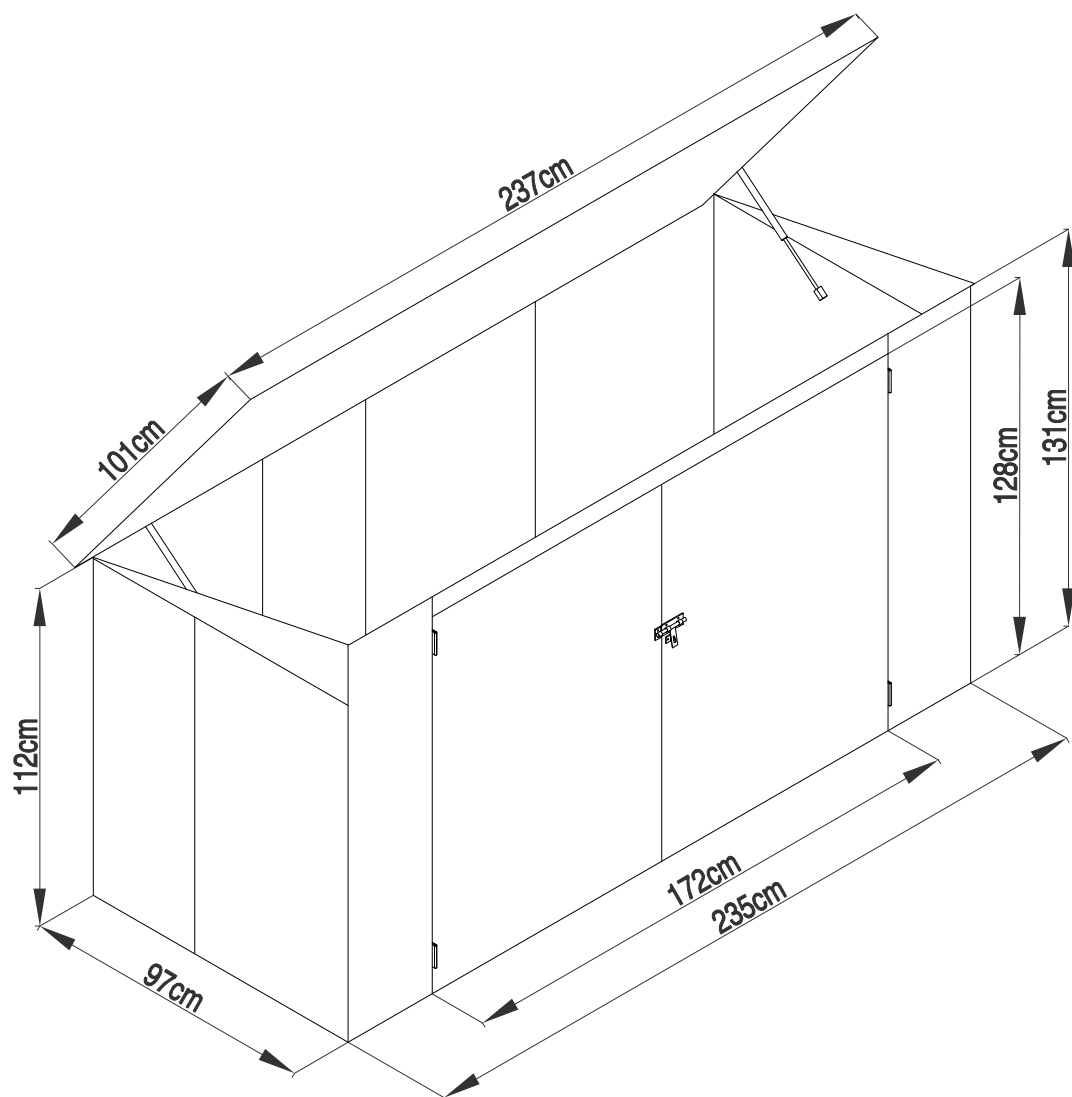



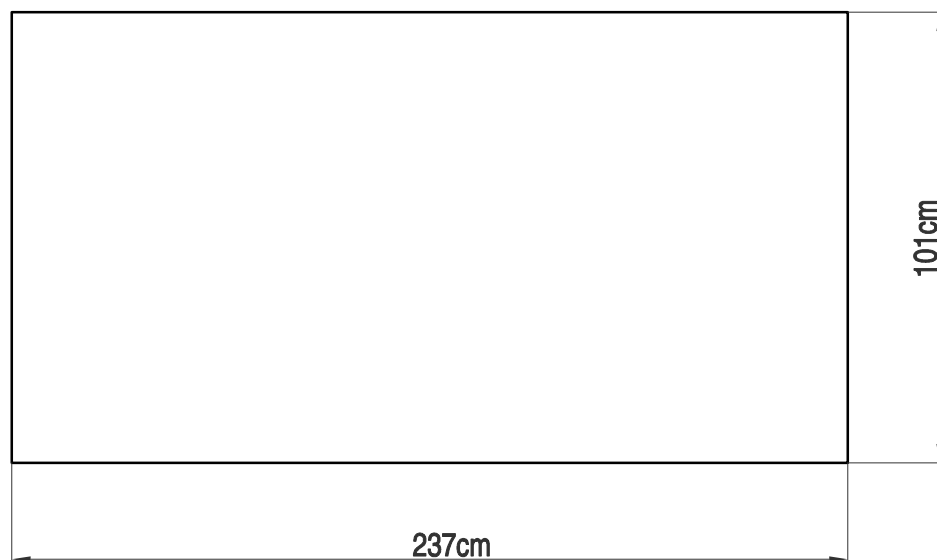

## Fundamentmaß

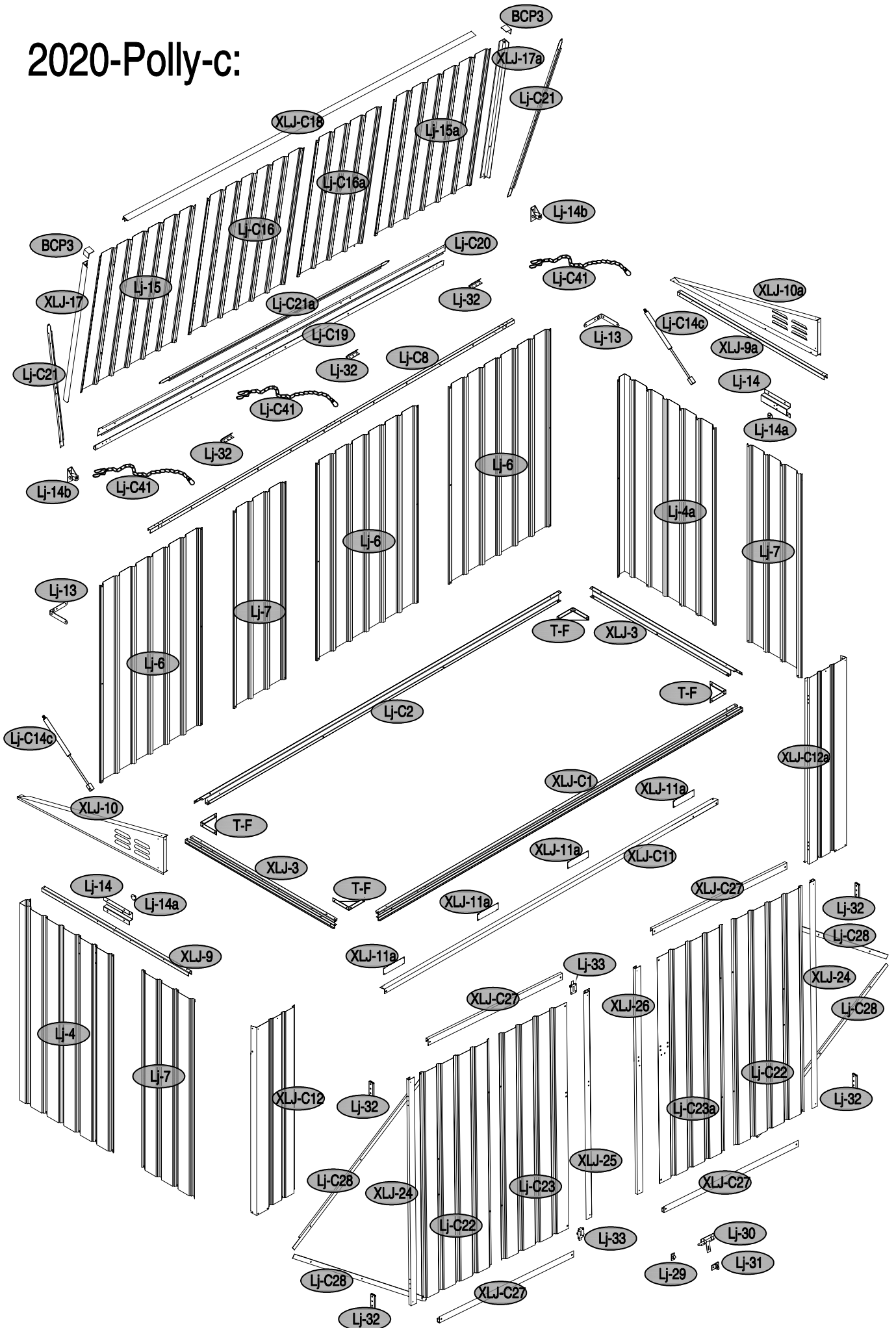



# 2020-Polly-c:



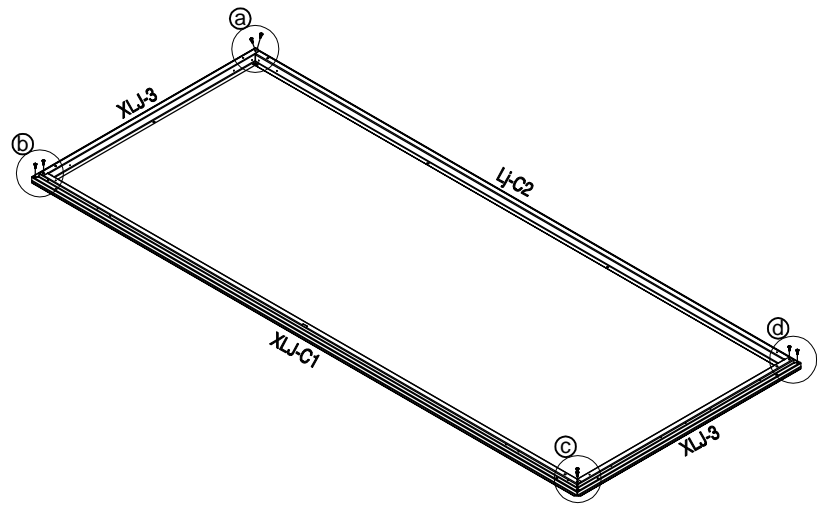
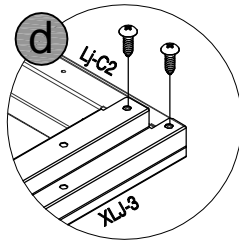
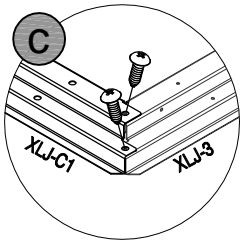
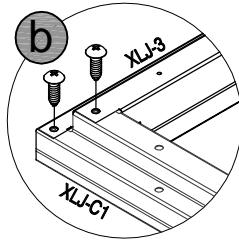
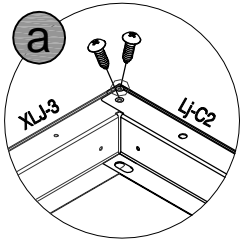

1	 XLJ-C1 [x1]	 Lj-C2 [x1]	 XLJ-3 [x2]	 Lj-C35 [x8]	
---	--	---	---	---	--





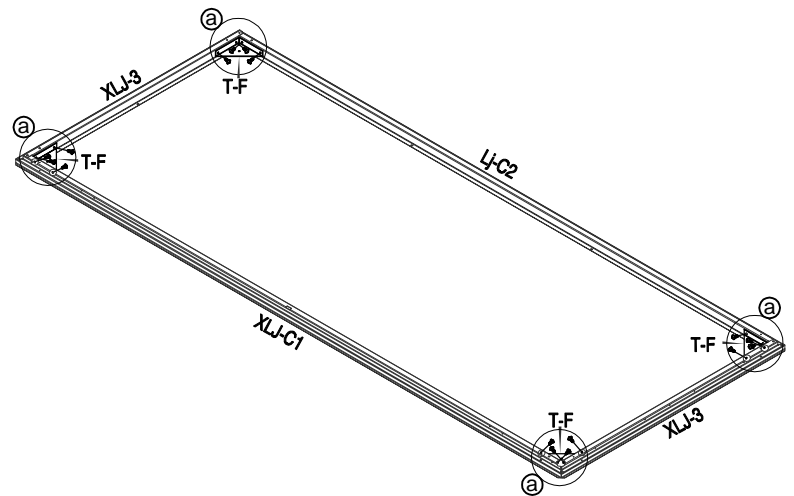
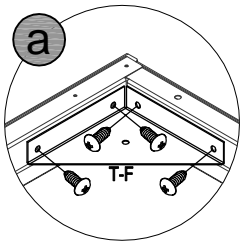

2	 T-F [x4]	 Lj-C35 [x16]	
---	---	---	--

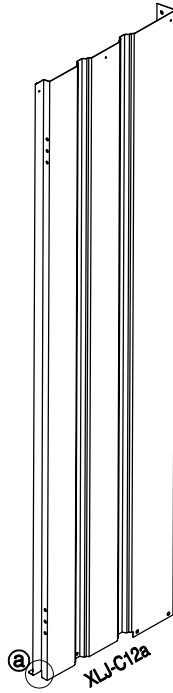
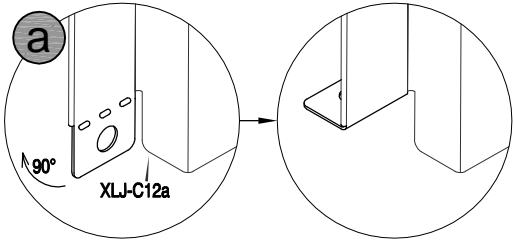





<b>3</b>		
	XLJ-C12a [x1]	

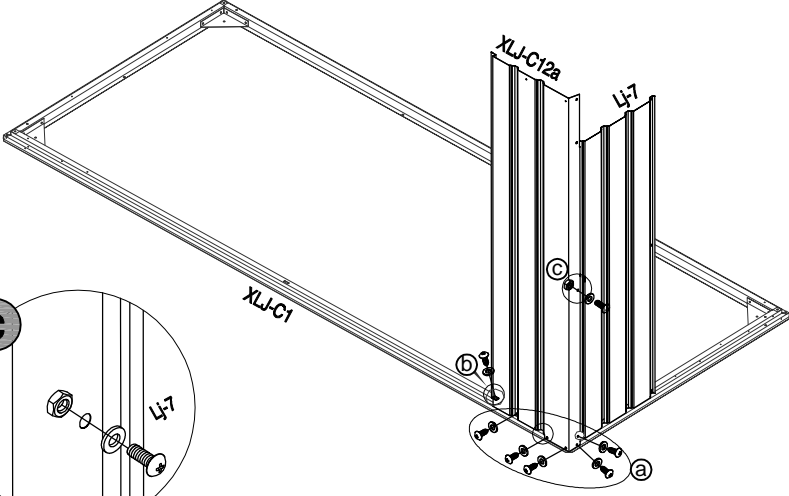
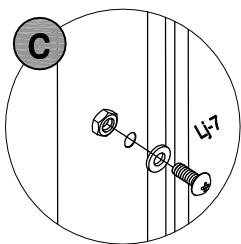
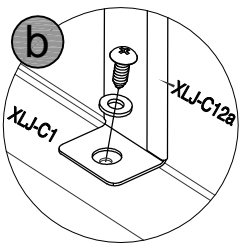
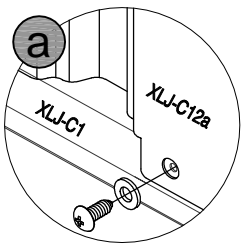
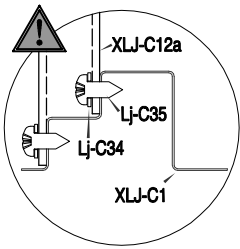
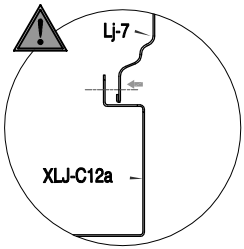

<b>4</b>					
	Lj-7 [x1]	Lj-C35 [x6]	Lj-C36 [x1]	Lj-C34 [x7]	





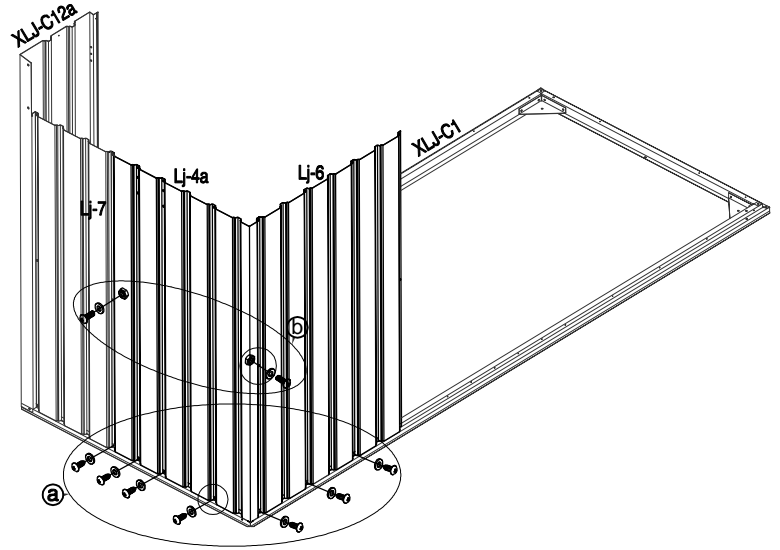
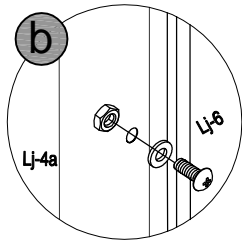
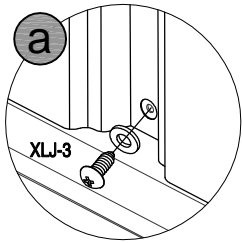
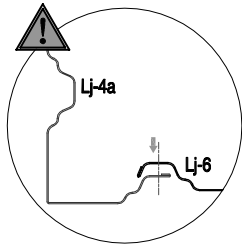
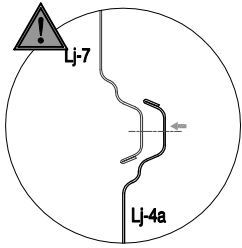

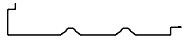
5	 Lj-4a [x1]	 Lj-6 [x1]	 Lj-C35 [x7]	 Lj-C36 [x2]	 Lj-C34 [x9]	
---	---	--	--	---	--	--

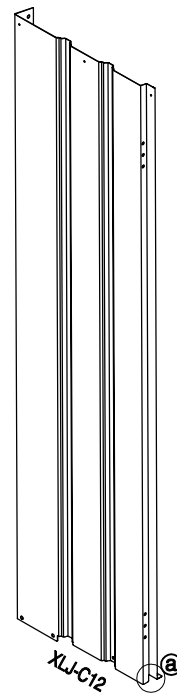
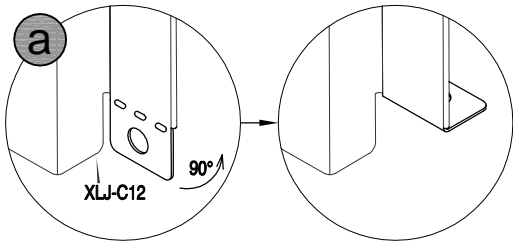





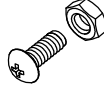

6	 XLJ-C12 [x1]	
---	---	--

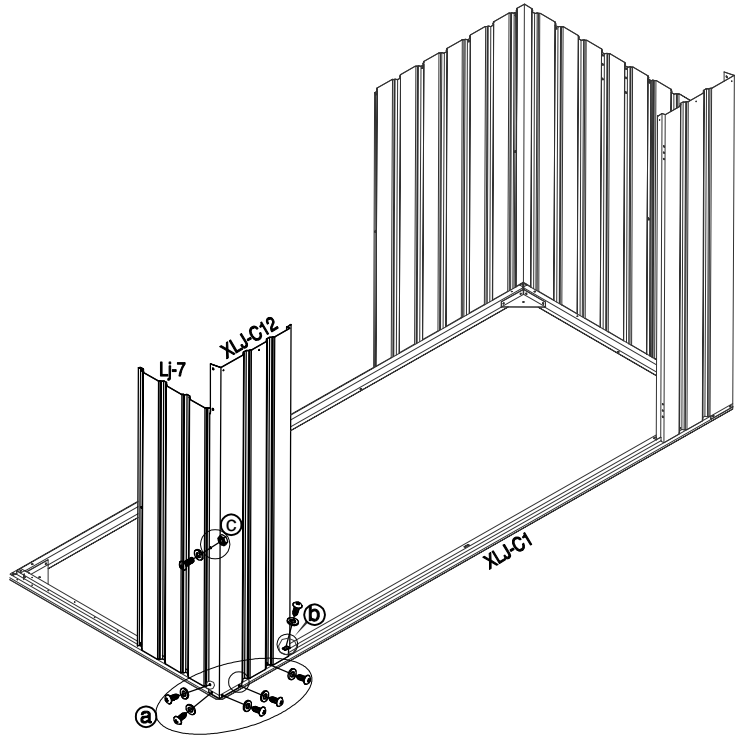
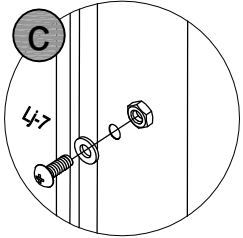
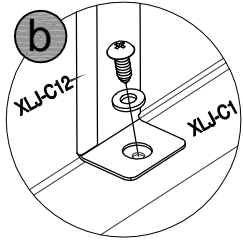
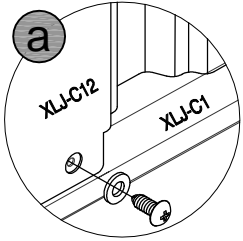
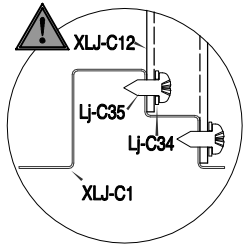
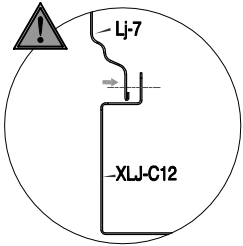







7	 Lj-7 [x1]	 Lj-C35 [x6]	 Lj-C36 [x1]	 Lj-C34 [x7]	
---	--	--	--	---	--

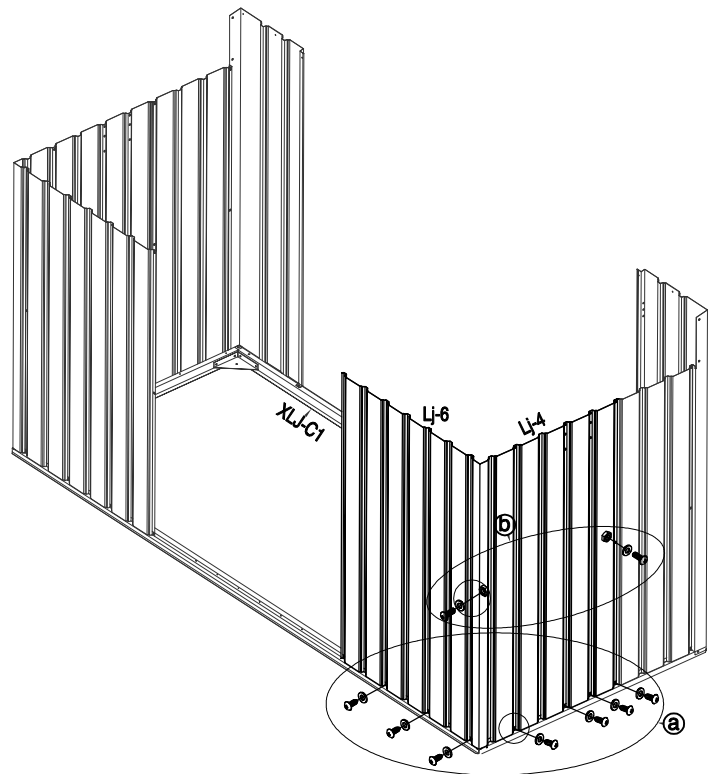
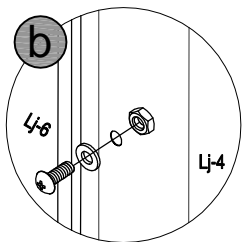
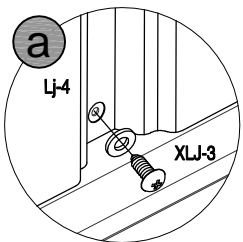
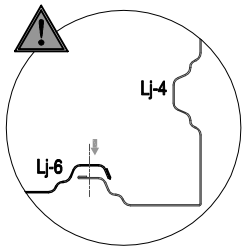
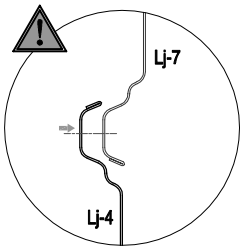

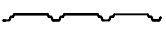
8	 Lj-4 [x1]	 Lj-6 [x1]	 Lj-C35 [x7]	 Lj-C36 [x2]	 Lj-C34 [x9]
---	--	--	--	---	--





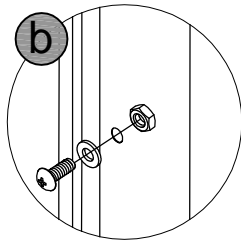
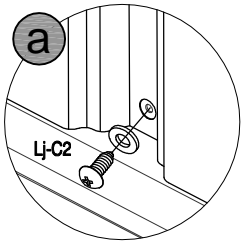
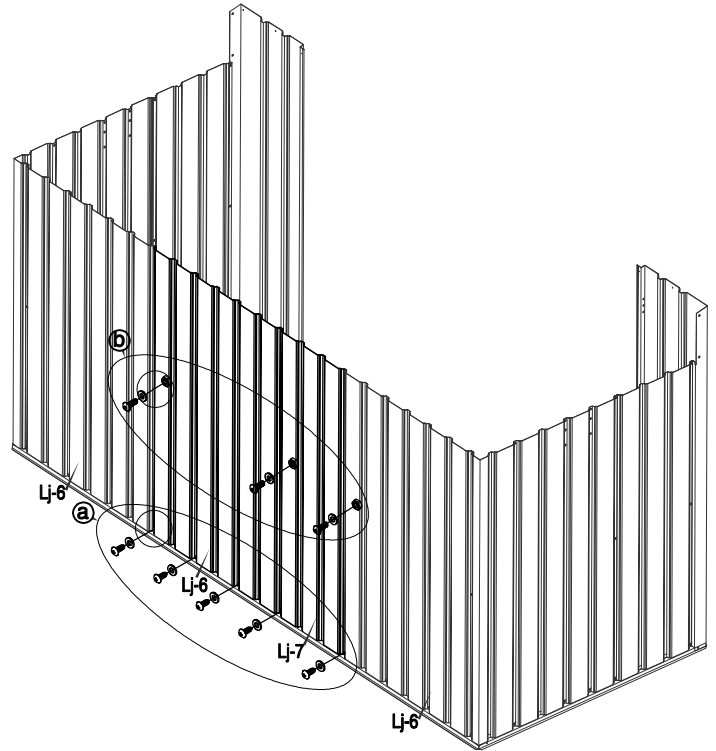
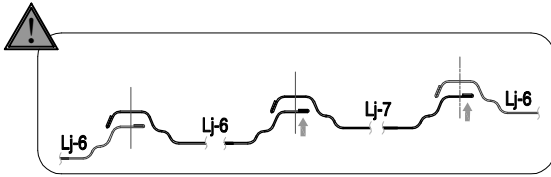

9	 Lj-7 [x1]	 Lj-6 [x1]	 Lj-C35 [x5]	 Lj-C36 [x3]	 Lj-C34 [x8]	
---	--	--	--	---	--	--

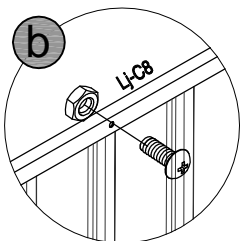
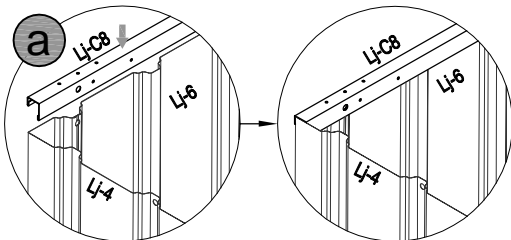
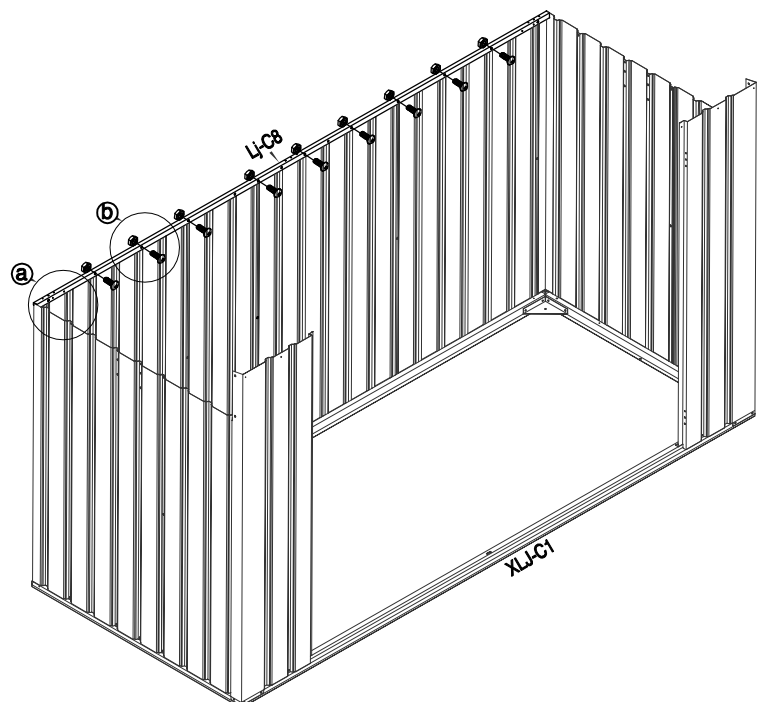
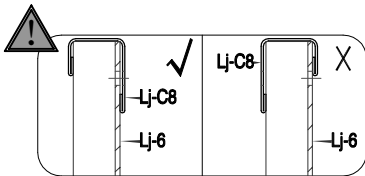



10	 Lj-C8 [x1]	 Lj-C36 [x9]	
----	---	--	--

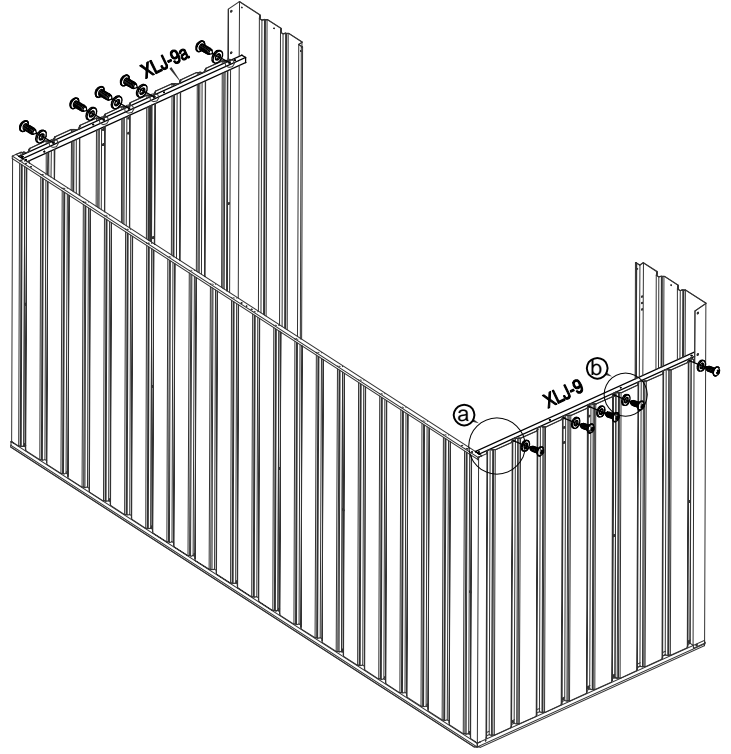
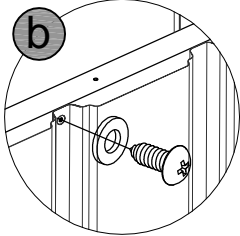
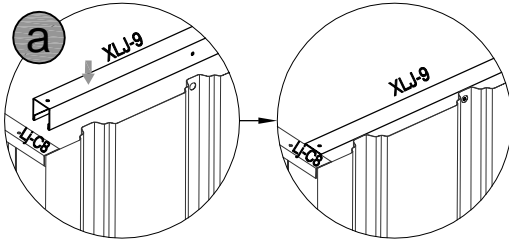

11	 XLJ-9 [x1]	 XLJ-9a [x1]	 Lj-C35 [x10]	 Lj-C34 [x10]	
----	---	--	---	--	--

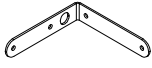

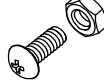

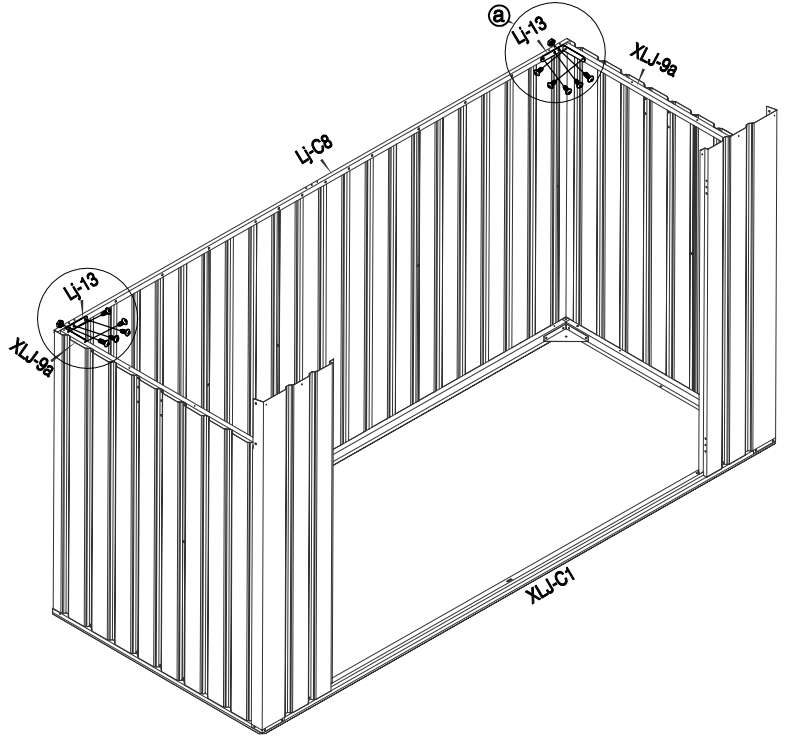
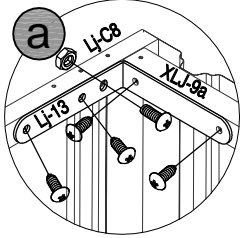
12	 Lj-13 [x2]	 Lj-C35 [x8]	 Lj-C36 [x2]	
----	---	--	--	--

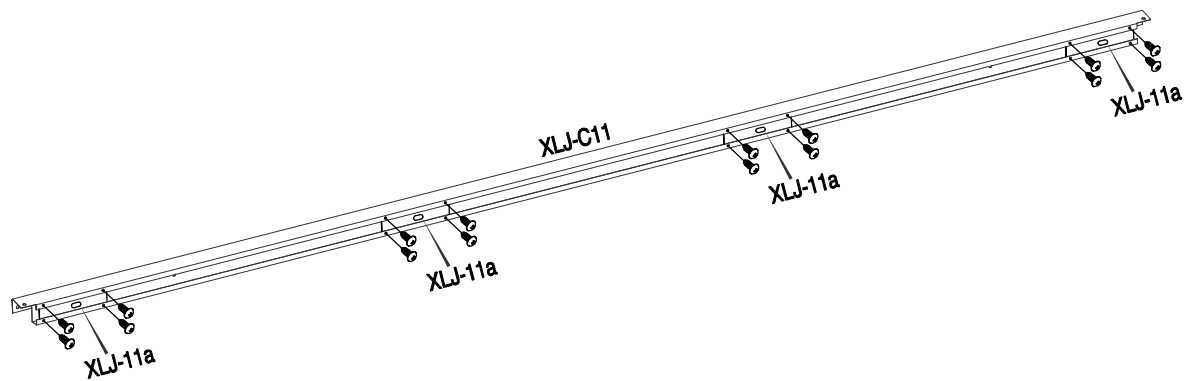
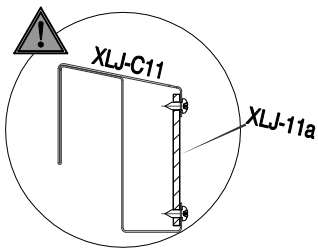
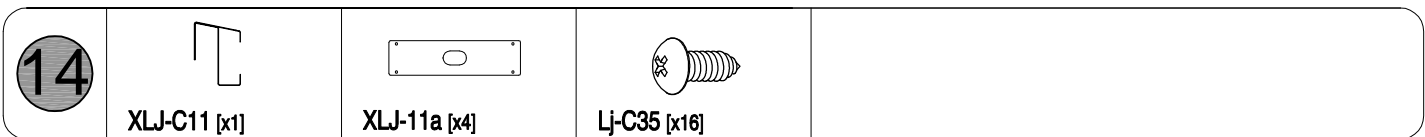
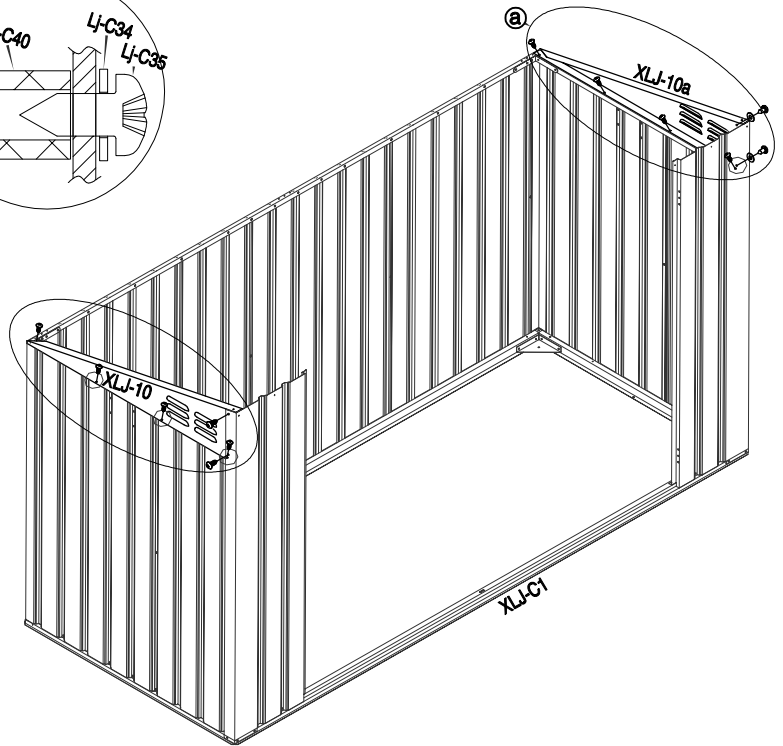
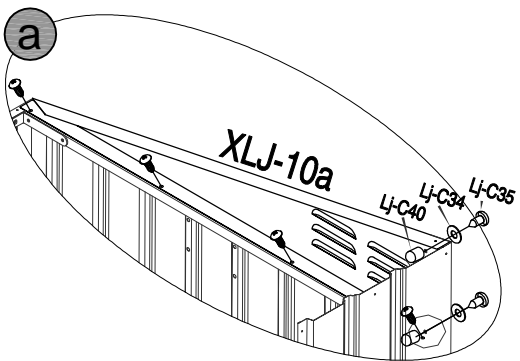
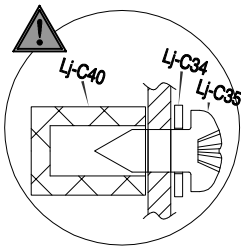
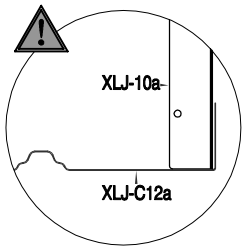
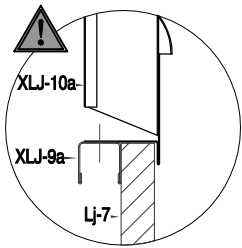
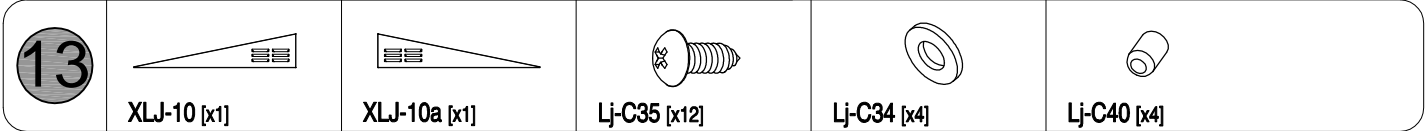



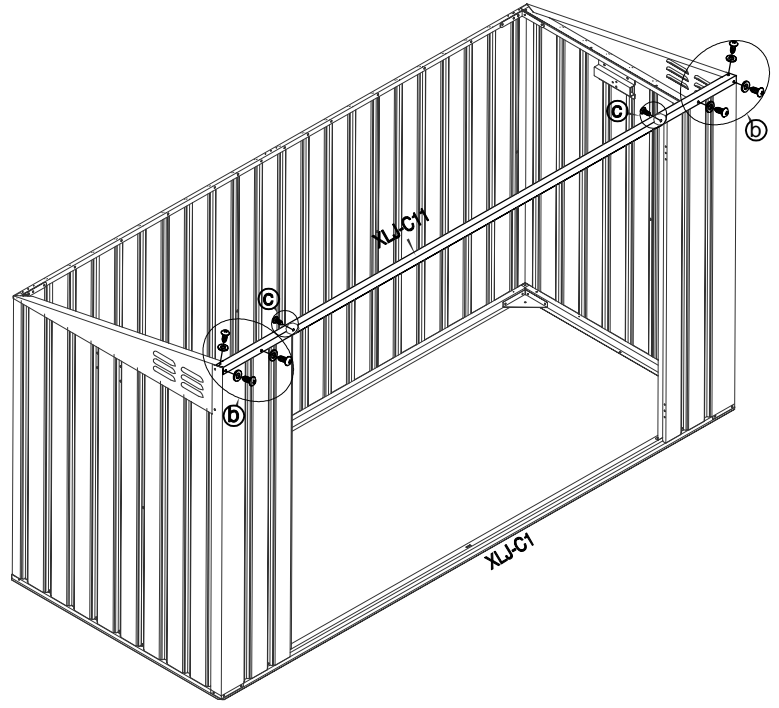
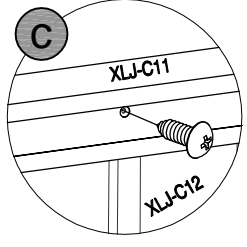
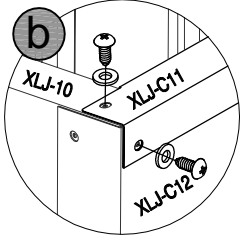
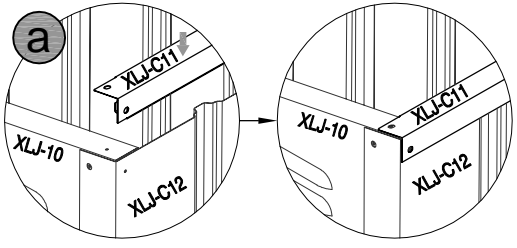

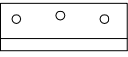

<b>15</b>	 <b>Lj-C35 [x8]</b>	 <b>Lj-C34 [x6]</b>	
-----------	---	---	--

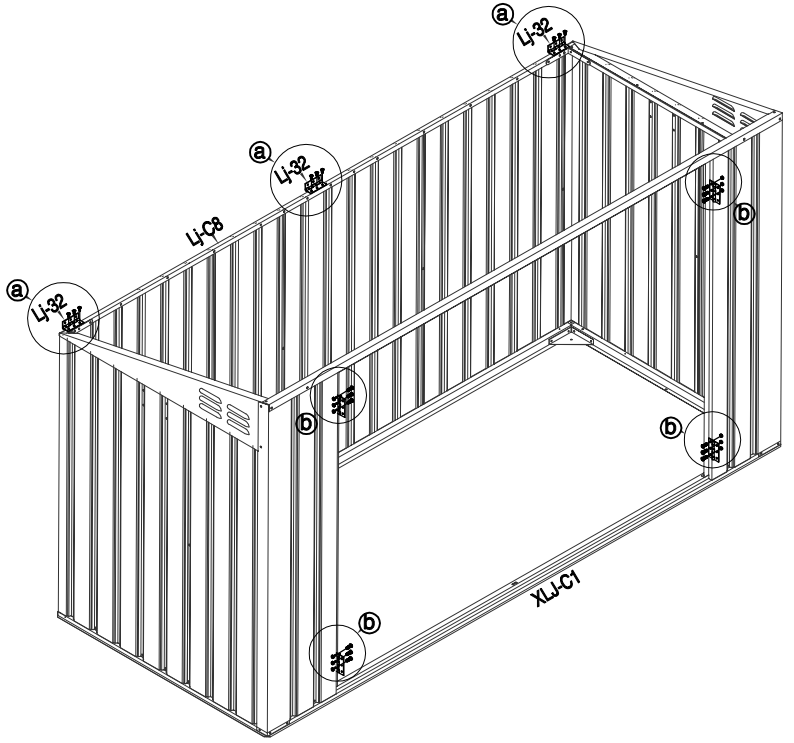
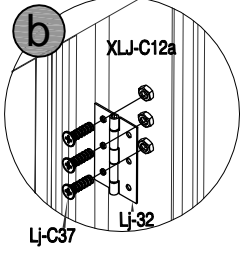
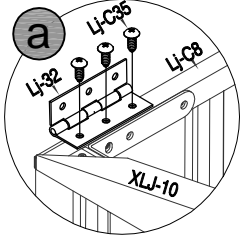



<b>16</b>	 <b>Lj-32 [x7]</b>	 <b>Lj-C35 [x9]</b>	 <b>Lj-C37 [x12]</b>	
-----------	--	---	--	--

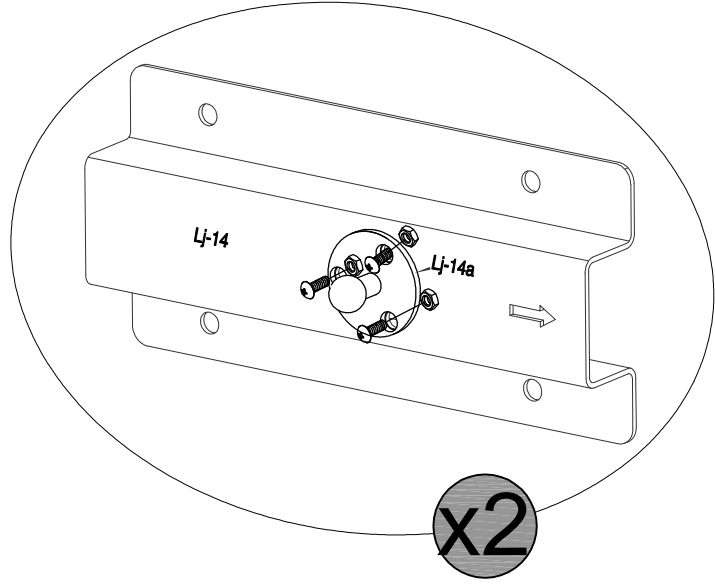
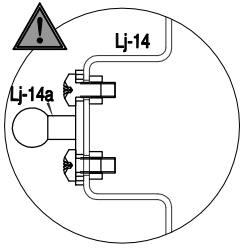

<p>17</p>	 <p>Lj-14 [x2]</p>	 <p>Lj-14a [x2]</p>	 <p>Lj-C36 [x8]</p>	
-----------	---	--	--	--

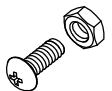

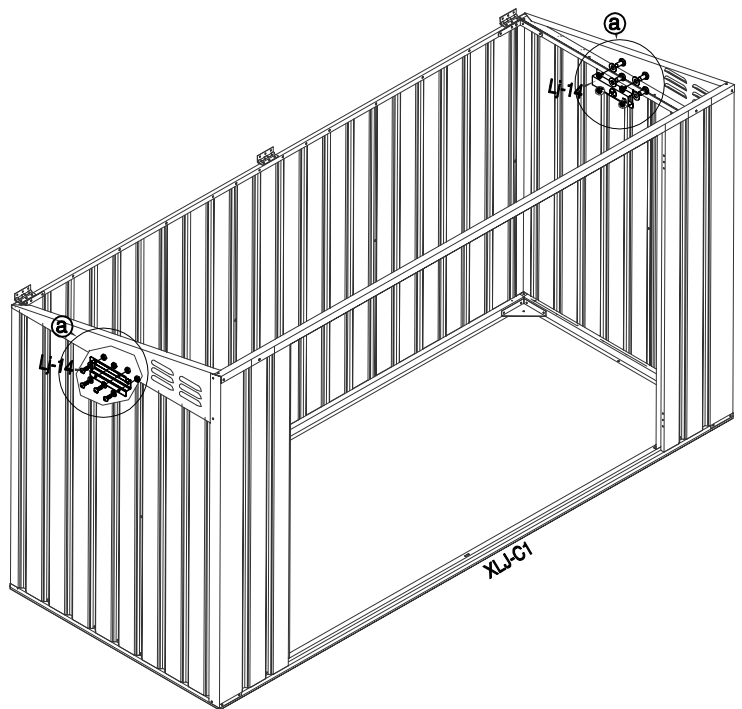
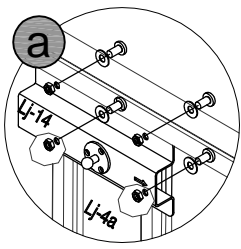
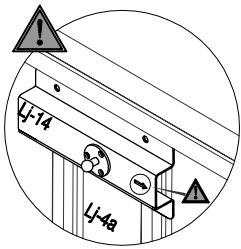

<p>18</p>	 <p>Lj-C36 [x8]</p>	 <p>Lj-C34 [x8]</p>	
-----------	--	--	--



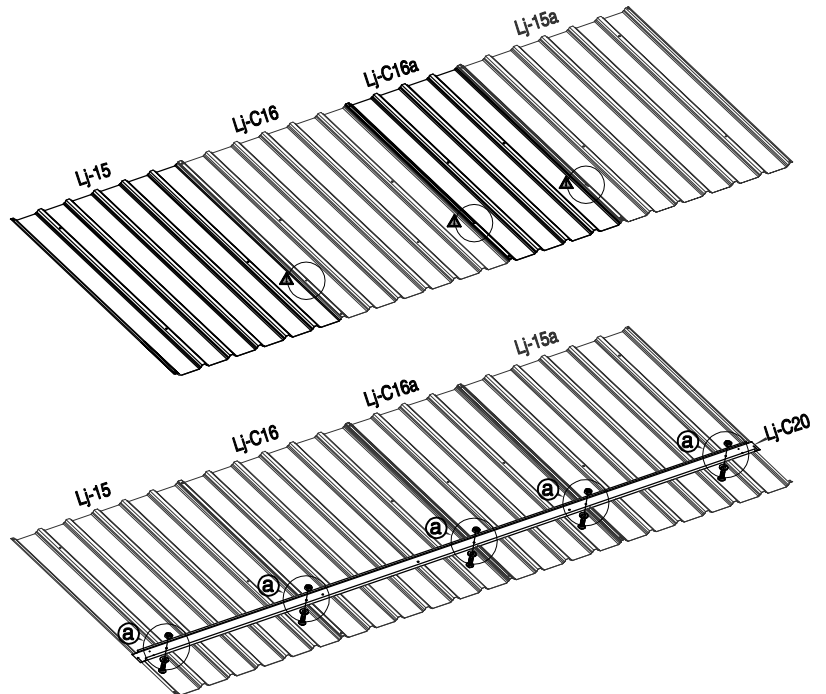
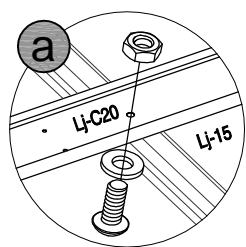
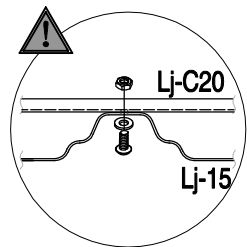
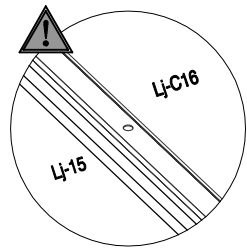
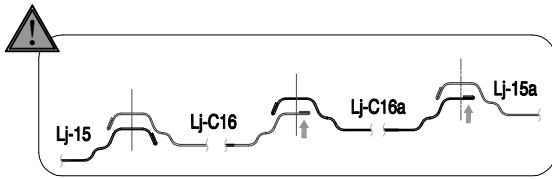

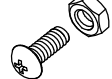

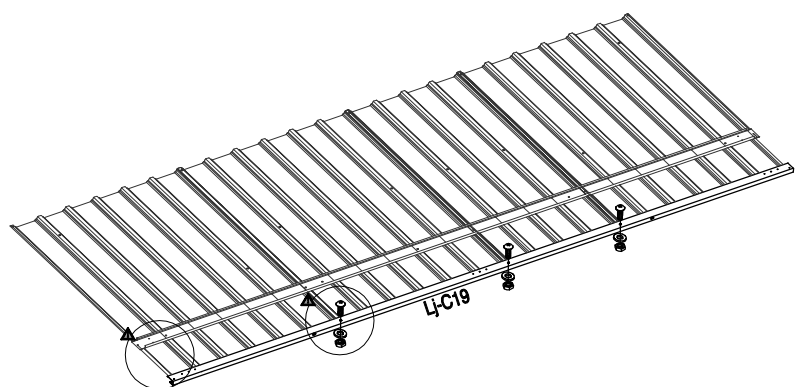
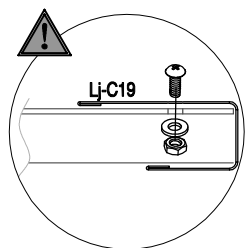
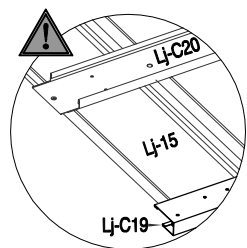

19	 Lj-15 [x1]	 Lj-15a [x1]	 Lj-C16 [x1]	 Lj-C16a [x1]	 Lj-C20 [x1]	 Lj-C36 [x5]
----	---	--	--	--	--	--







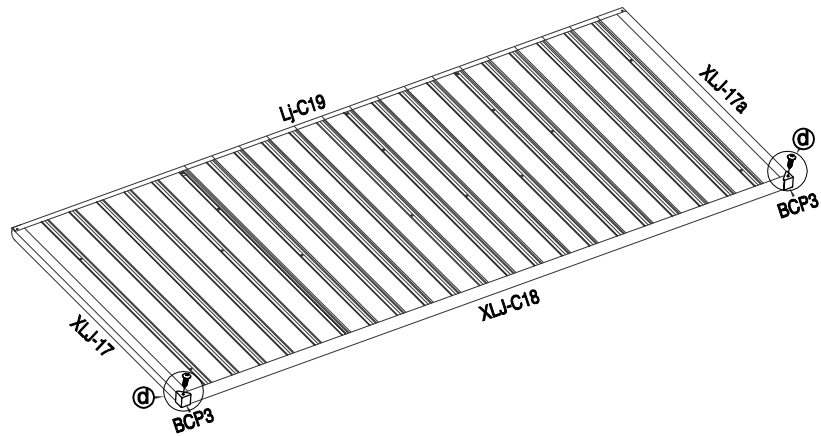
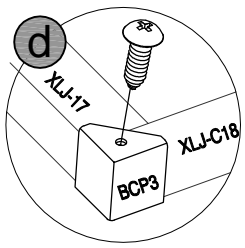
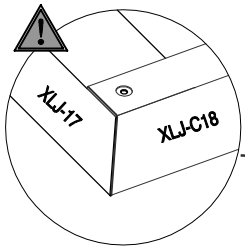
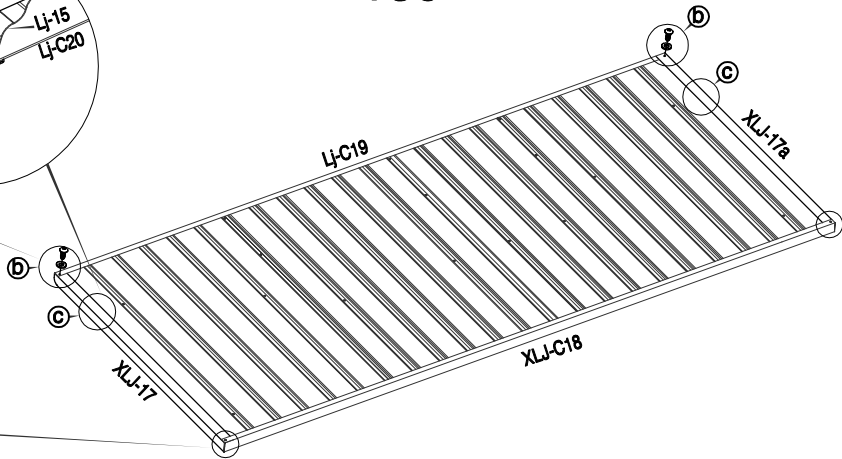
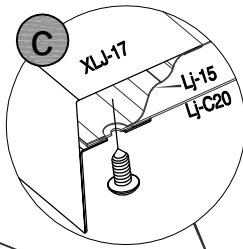
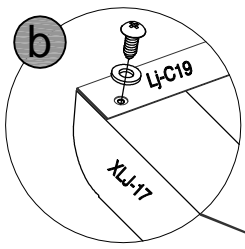
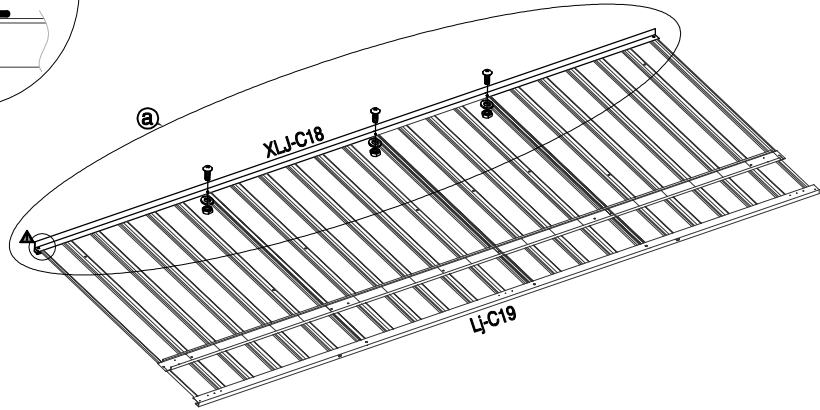
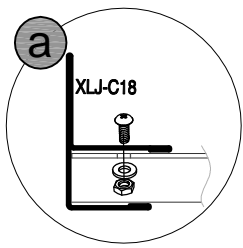
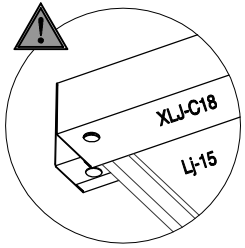

20	 Lj-C19 [x1]	 Lj-C36 [x3]	 Lj-C34 [x3]	
----	--	--	--	--



21	 XLJ-C18 [x1]	 XLJ-17 [x1]	 XLJ-17a [x1]	 BCP3 [x2]	 Lj-C36 [x3]	 Lj-C35 [x6]
						 Lj-C34 [x5]





22	 Lj-C21 [x2]	 Lj-C21a [x1]	 Lj-14b [x2]	 Lj-C35 [x10]	 Lj-C36 [x4]	 Lj-C34 [x4]
----	---	--	---	---	---	---

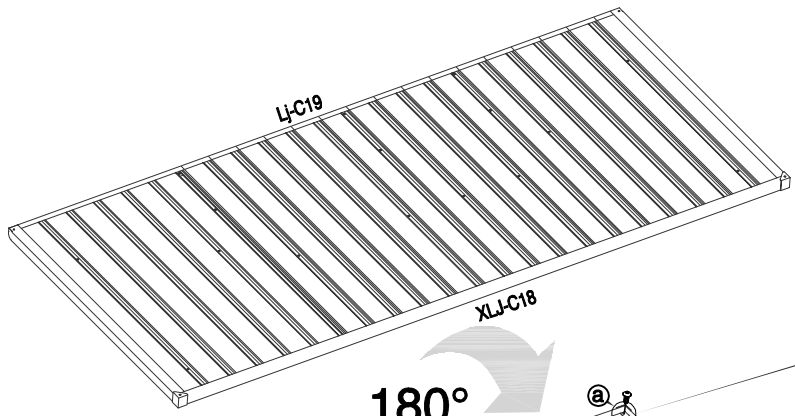

180°

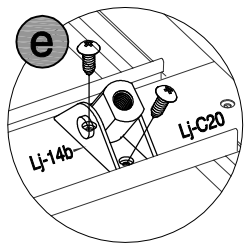
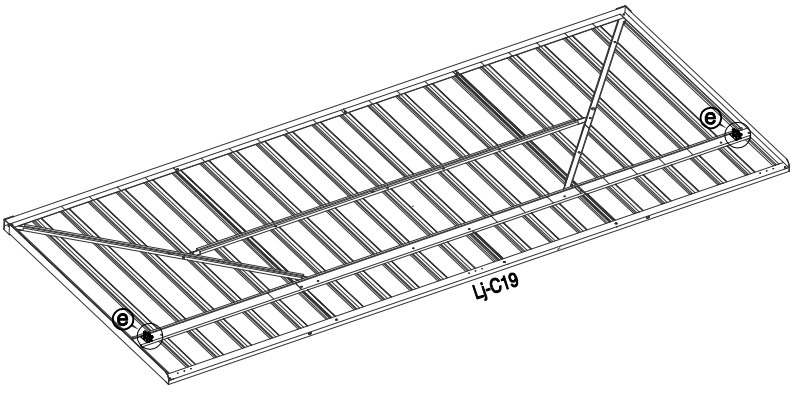
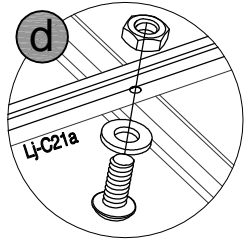
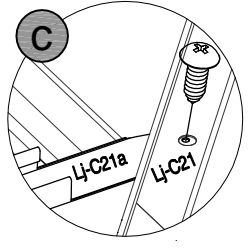
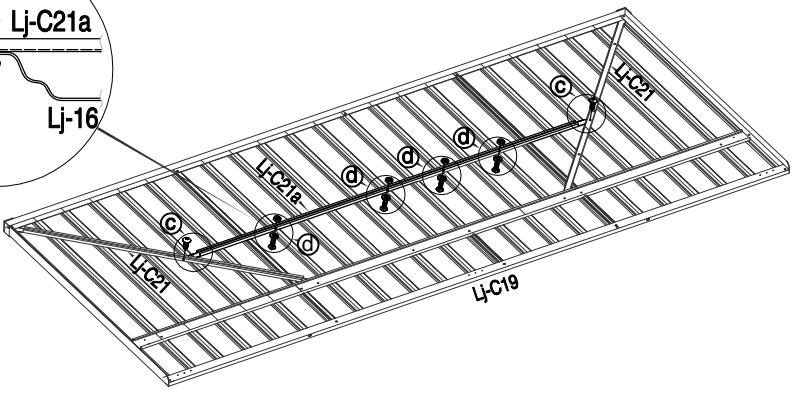
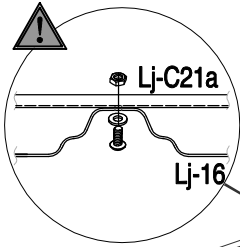
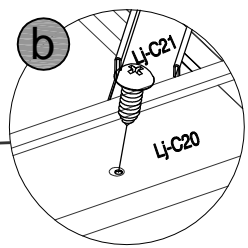
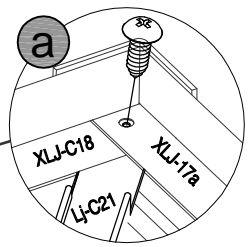
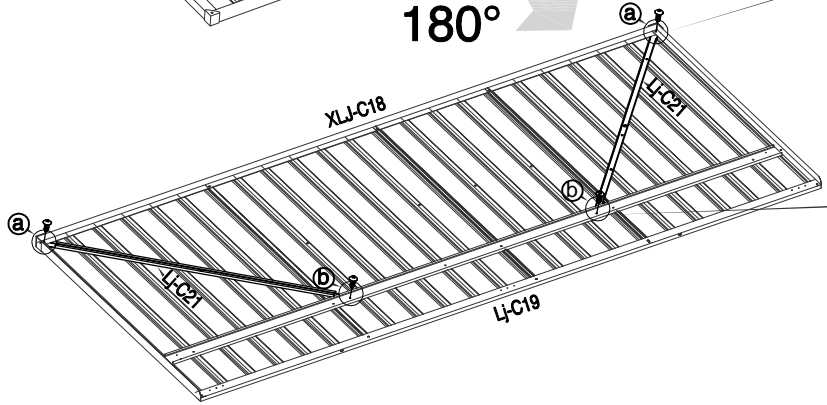

23



Lj-C35 [x9]

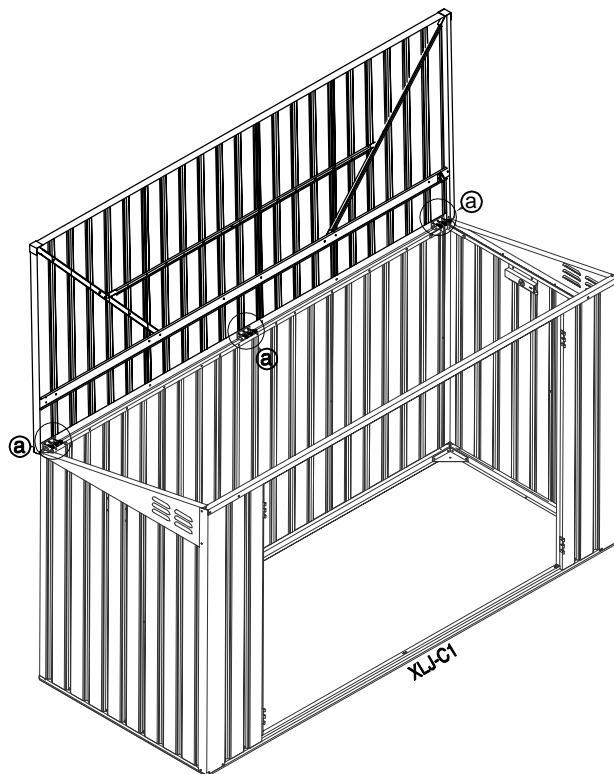
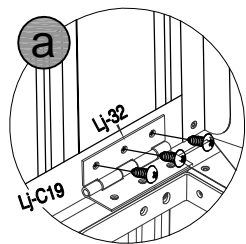



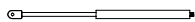

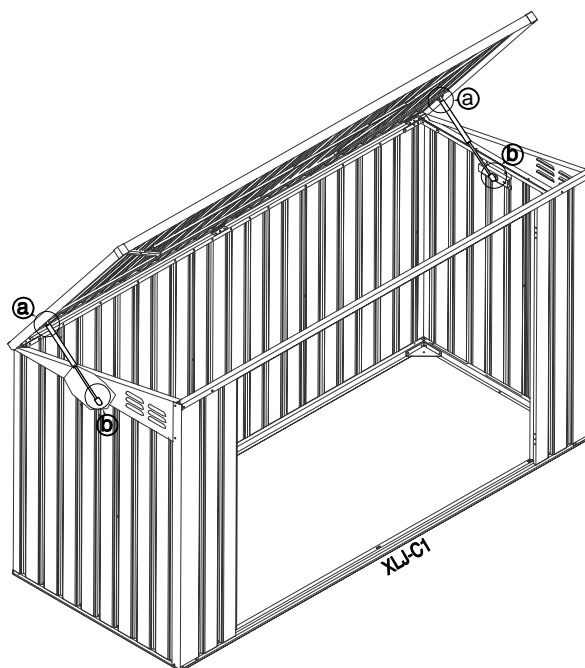
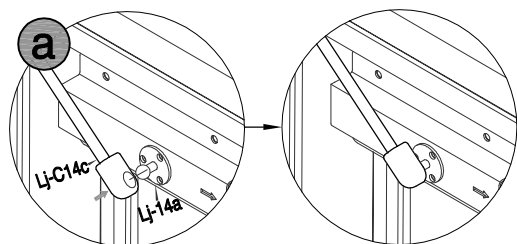
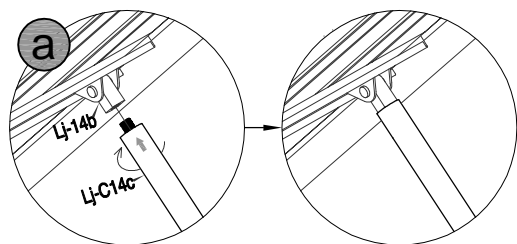

24



Lj-C14c [x2]





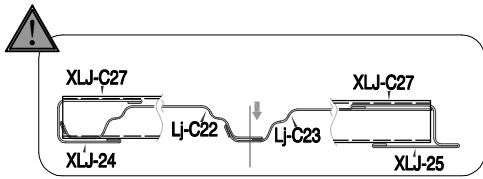

<b>25</b>	 Lj-C22 [x1]	 Lj-C23 [x1]	 XLJ-C27 [x2]	 XLJ-24 [x1]	 XLJ-25 [x1]	 Lj-C35 [x4]
-----------	--	--	---	--	--	--

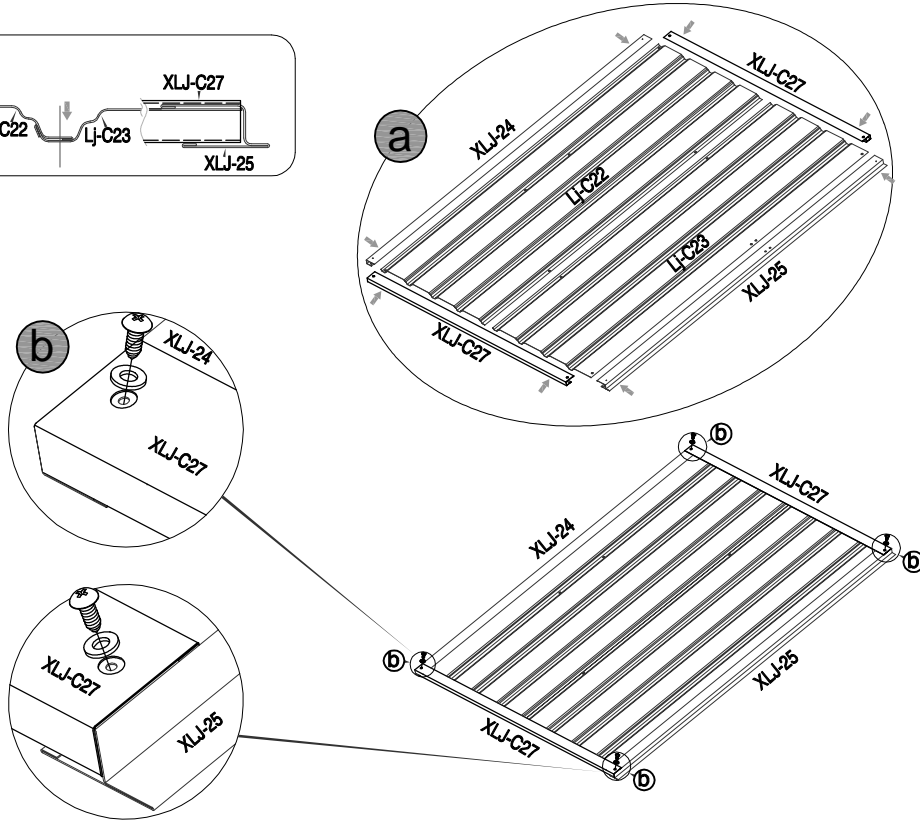

 Lj-C34 [x4]
--





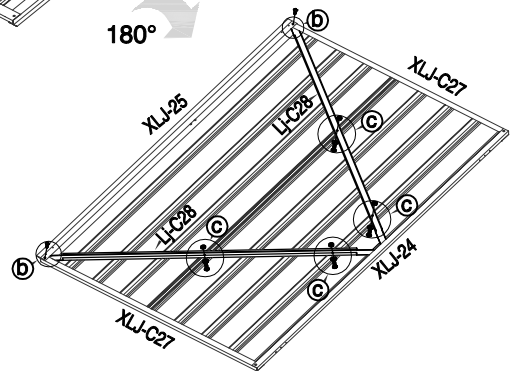
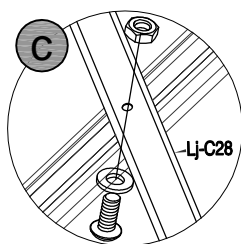
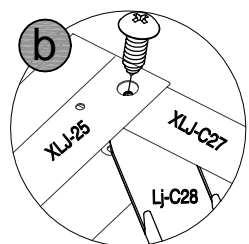
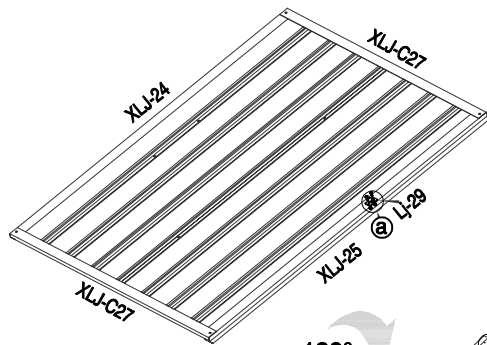
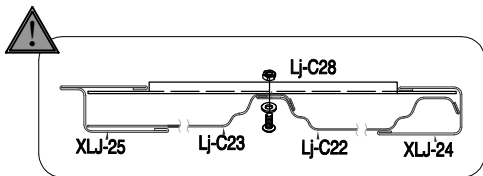
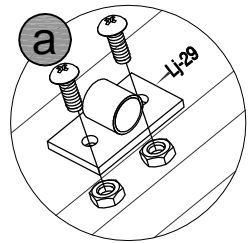

<b>26</b>	 Lj-29 [x1]	 Lj-C28 [x2]	 Lj-C35 [x2]	 Lj-C36 [x4]	 Lj-C34 [x4]	
-----------	---	--	--	---	--	--

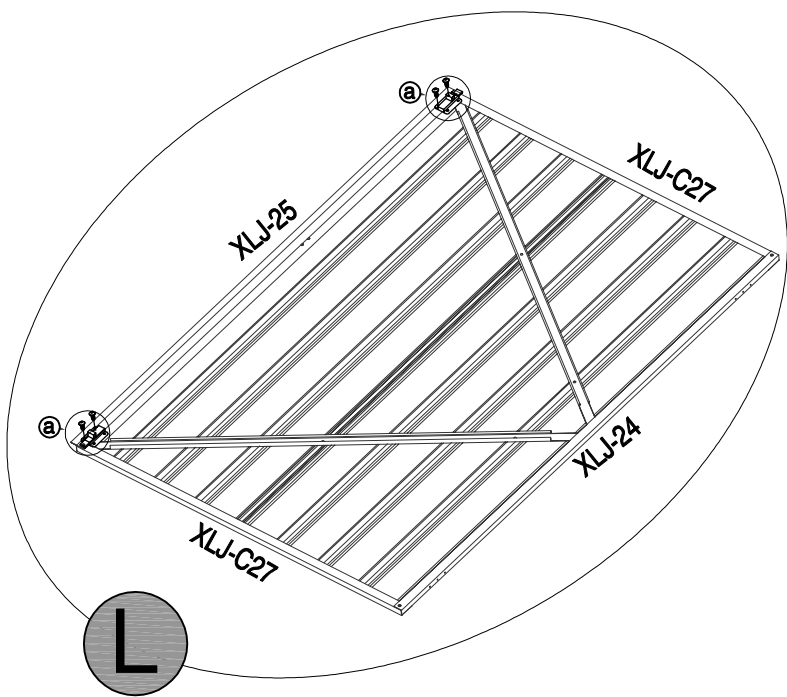
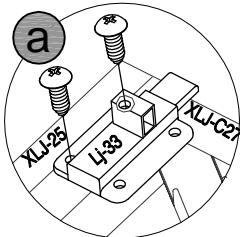

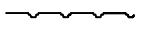
27	 Lj-33 [x2]	 Lj-C35 [x4]	
----	---	--	--





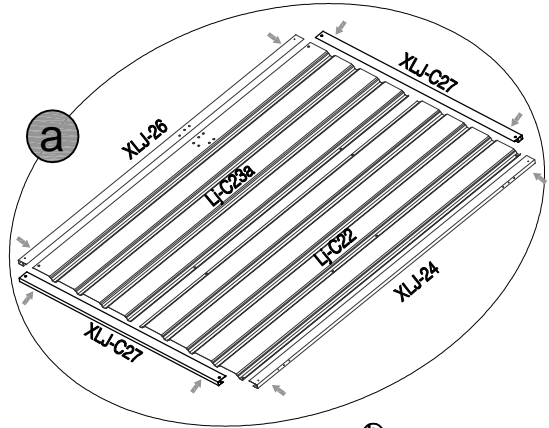
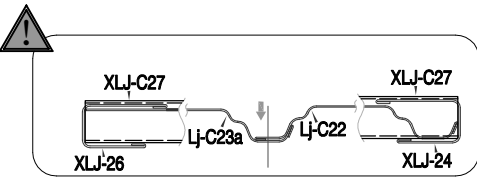

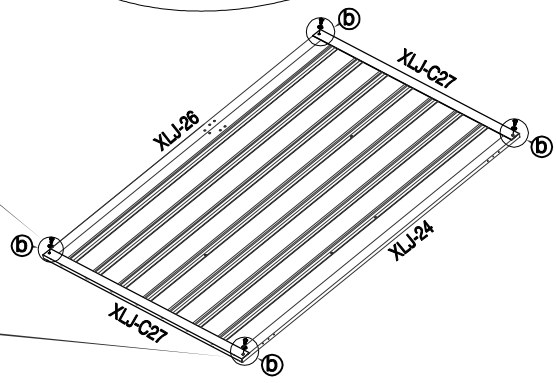
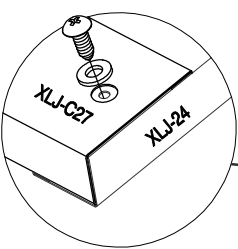
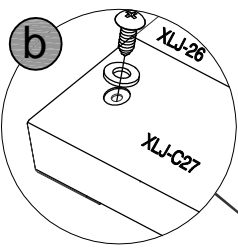

28	 Lj-C22 [x1]	 Lj-C23a [x1]	 XLJ-C27 [x2]	 XLJ-24 [x1]	 XLJ-26 [x1]	 Lj-C35 [x4]
----	--	---	---	--	--	--

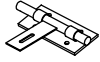

 Lj-C34 [x4]
--



	 <p>Lj-30 [x1]</p>	 <p>Lj-31 [x1]</p>	 <p>Lj-C28 [x2]</p>	 <p>Lj-C35 [x2]</p>	 <p>Lj-C36 [x10]</p>	 <p>Lj-C34 [x4]</p>
--	---	---	--	---	---	--

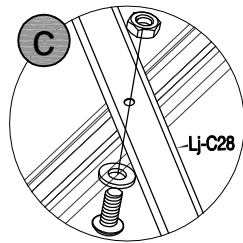
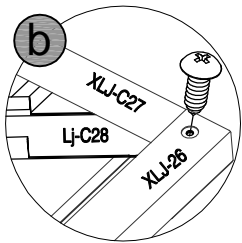
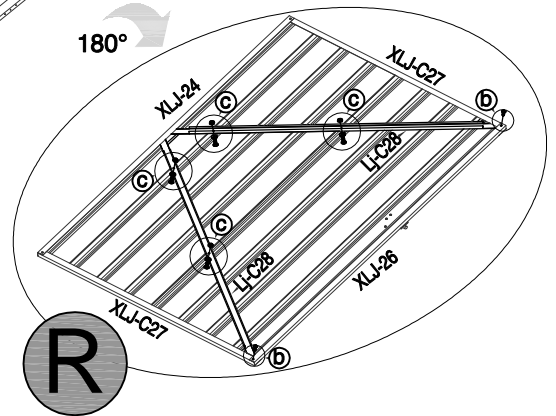
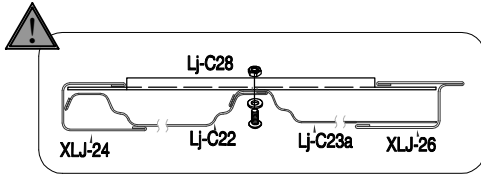
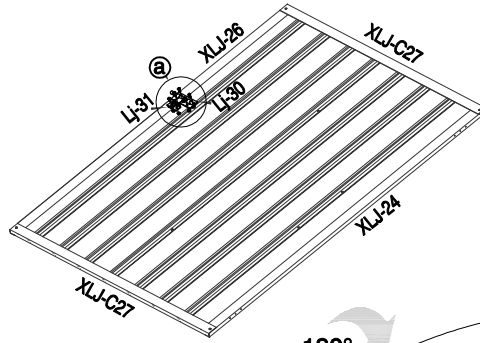
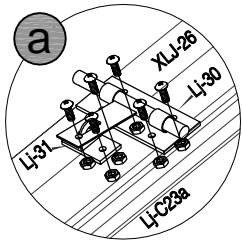

	 <p>Lj-C35 [x6]</p>	
--	--	--

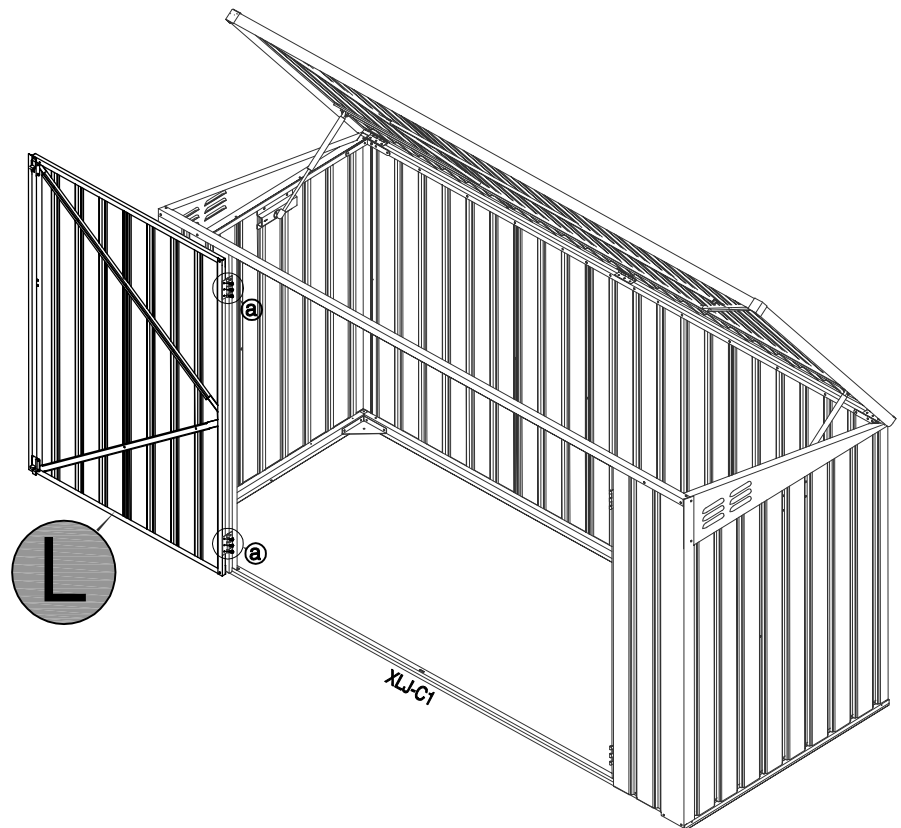
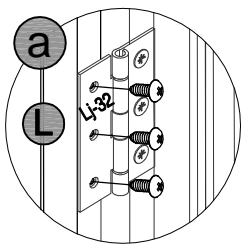

31



Lj-C35 [x6]

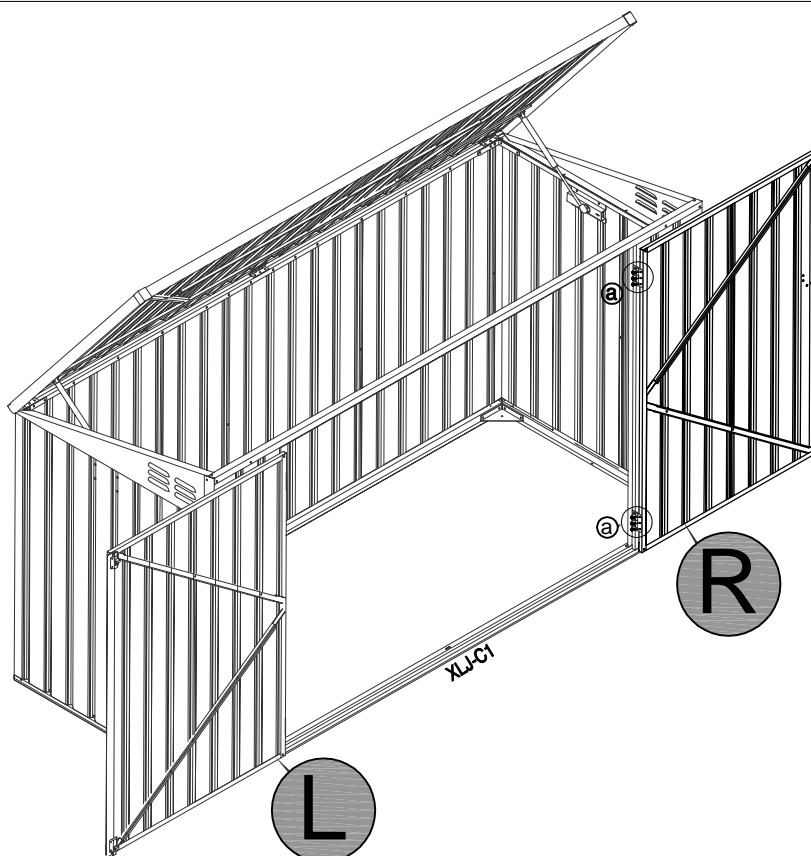
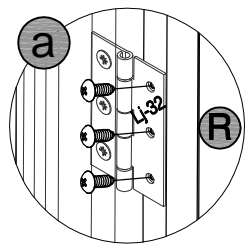

32



Lj-C41 [x3]

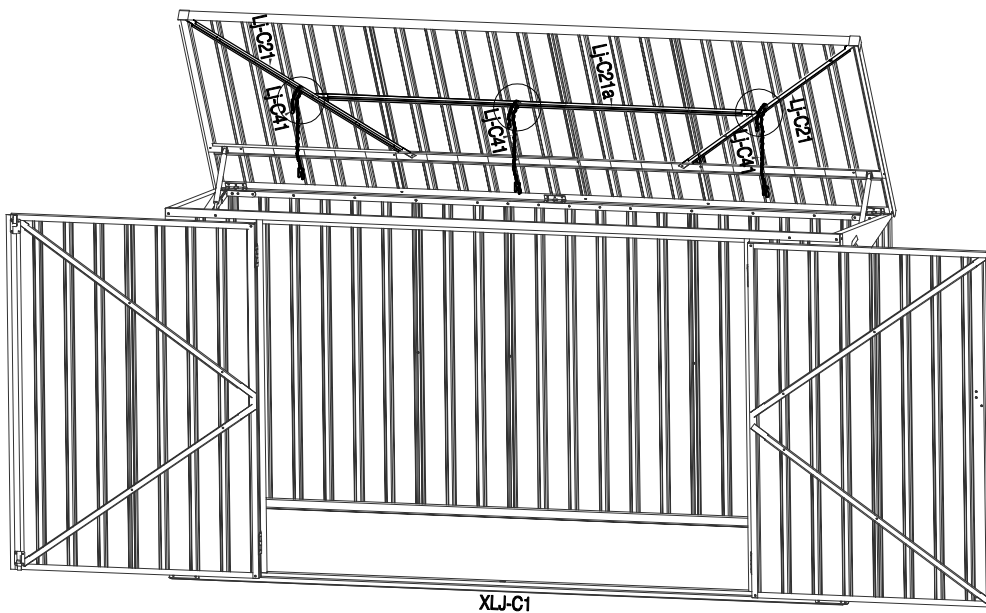
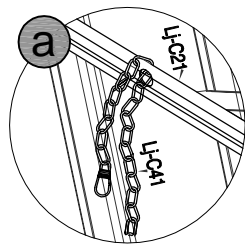
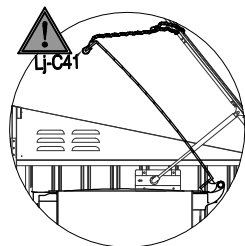

33

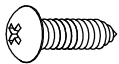

Lj-C38 [x10]

