

A315

MONTAGEANLEITUNG / ASSEMBLY INSTRUCTION

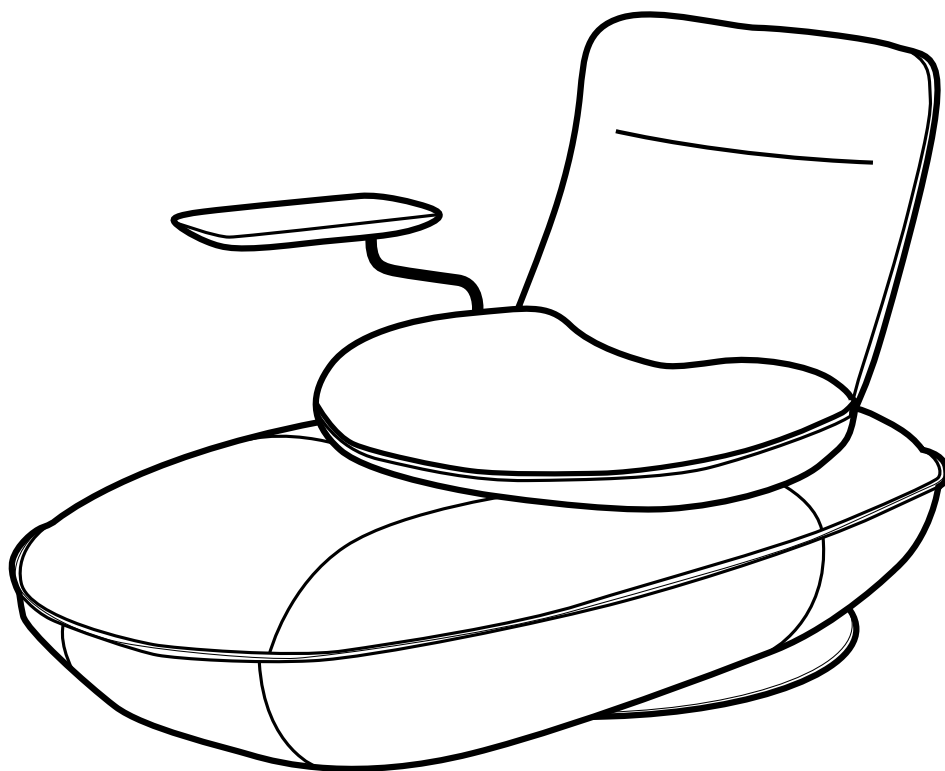

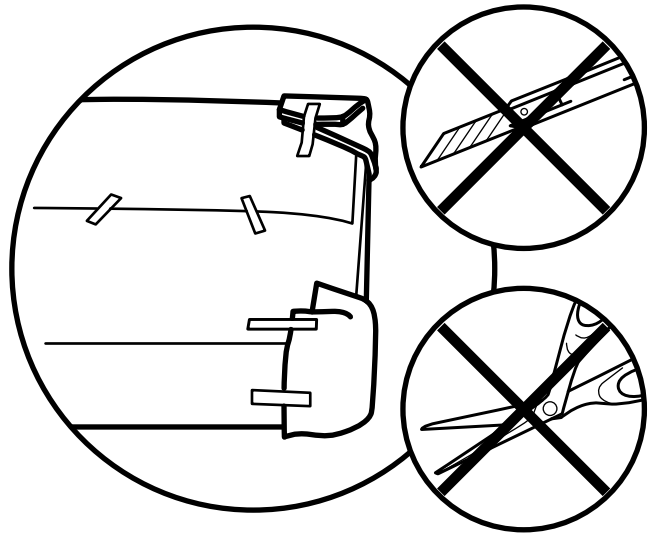
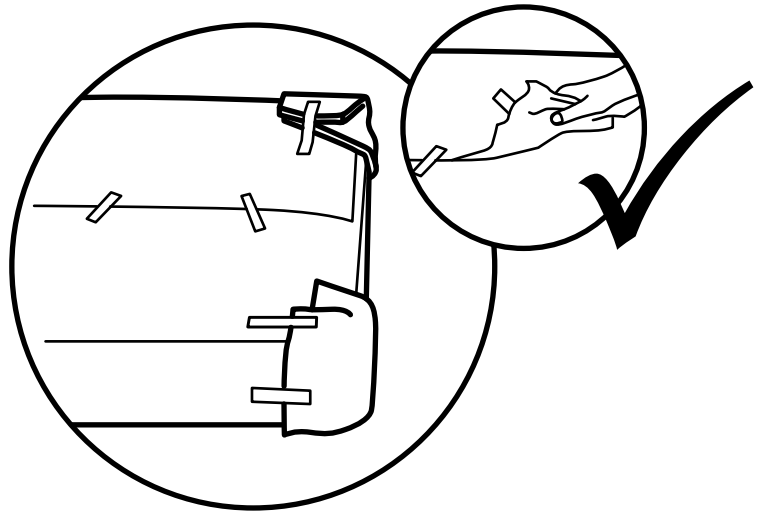
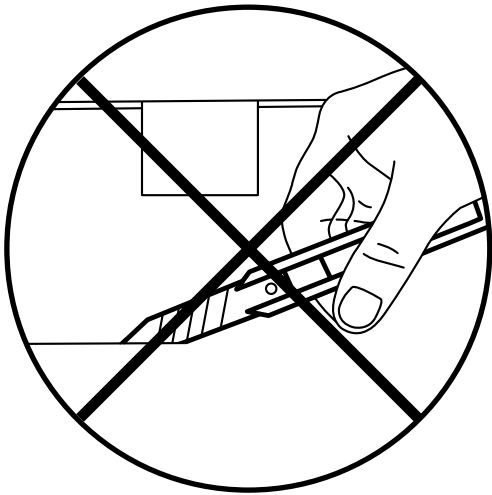
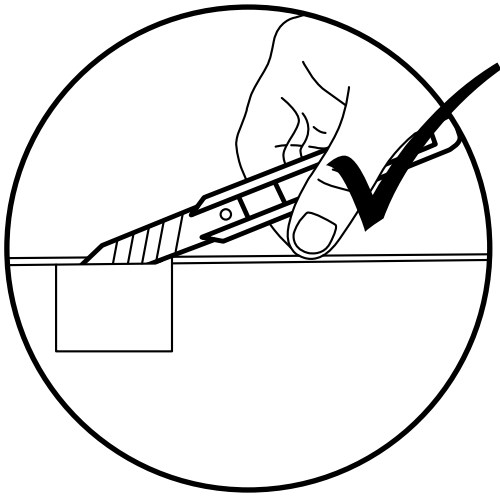

! Hinweis / Note:

Für den Aufbau werden zwei Monteure benötigt. Somit vermeiden Sie vorsorglich Beschädigungen.

*Two persons are needed for the assembly.
This prevents damage in advance.*

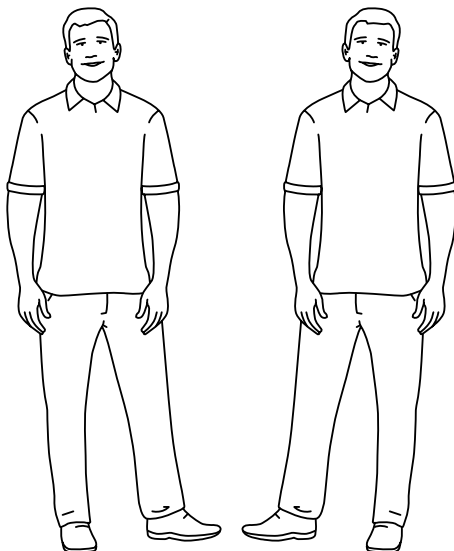

Maßstab 1:1, scale of one to one

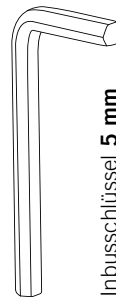

Inbusschlüssel 5 mm
Allen key 5 mm

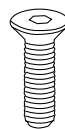

Senkkopfschraube M8x15
Countersunk screw M8x15

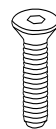

Senkkopfschraube M6x15
Countersunk screw M6x15
Modellabhängig für
Tisch-Montage
Model specific for
table assembly

1 Montage Bodenplatte / *Assembly base plate*

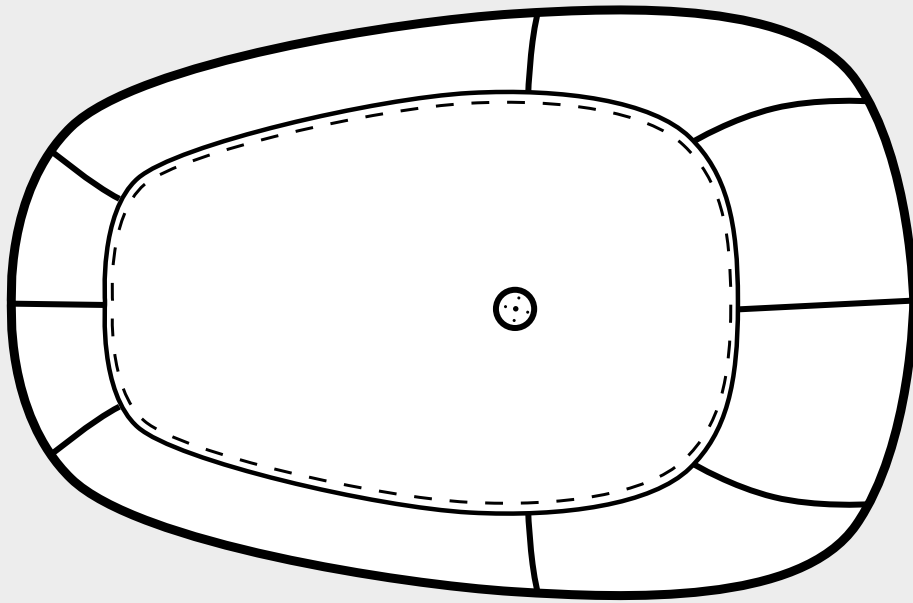

Unterlage / Verpackungsfolie
underlay / packaging foil

2

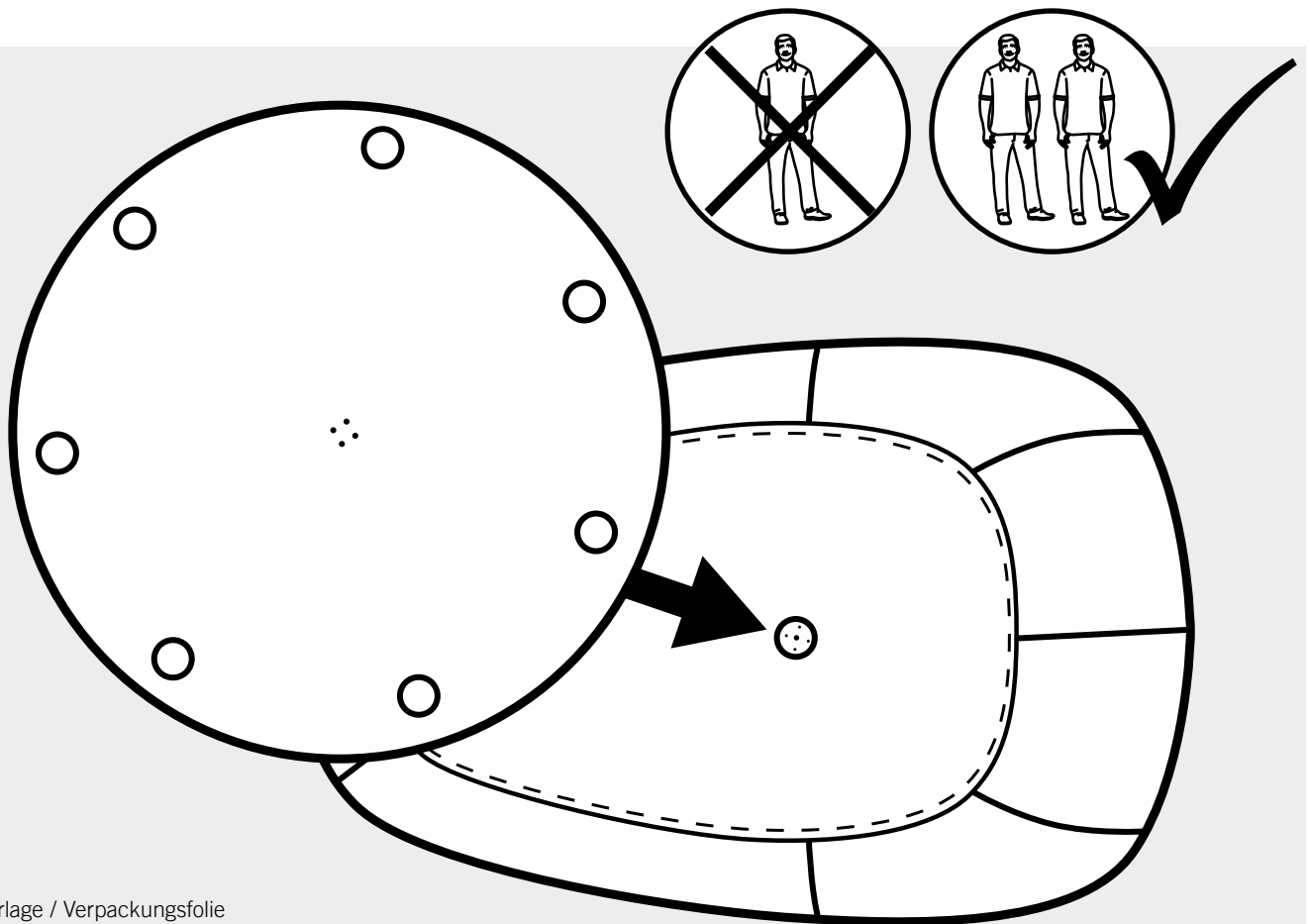

Unterlage / Verpackungsfolie
underlay / packaging foil

3

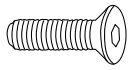

Senkkopfschraube **M8x15**
Countersunk screw **M8x15**

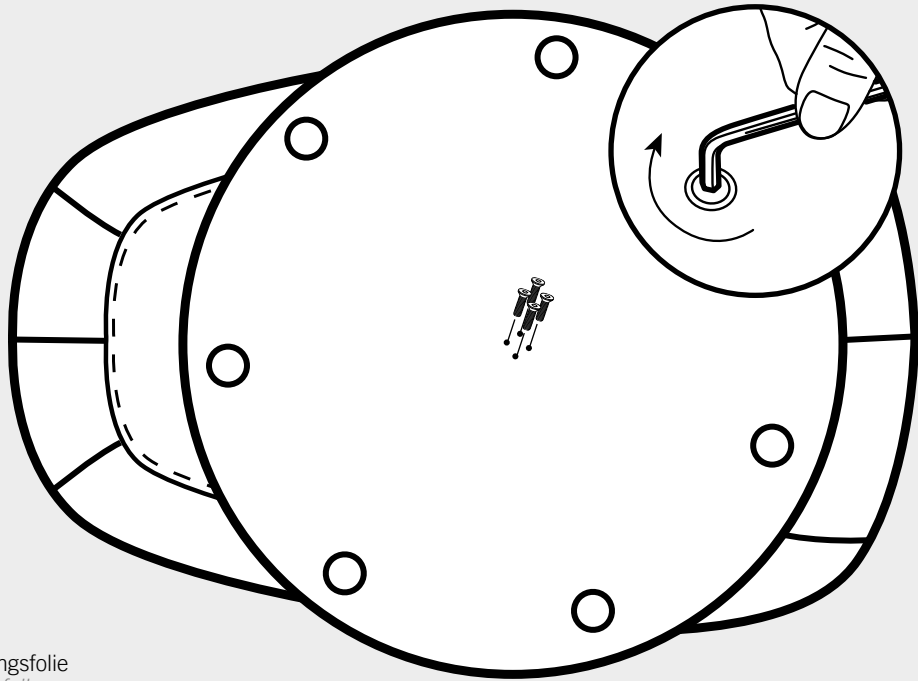

Unterlage / Verpackungsfolie
underlay / packaging foil

4

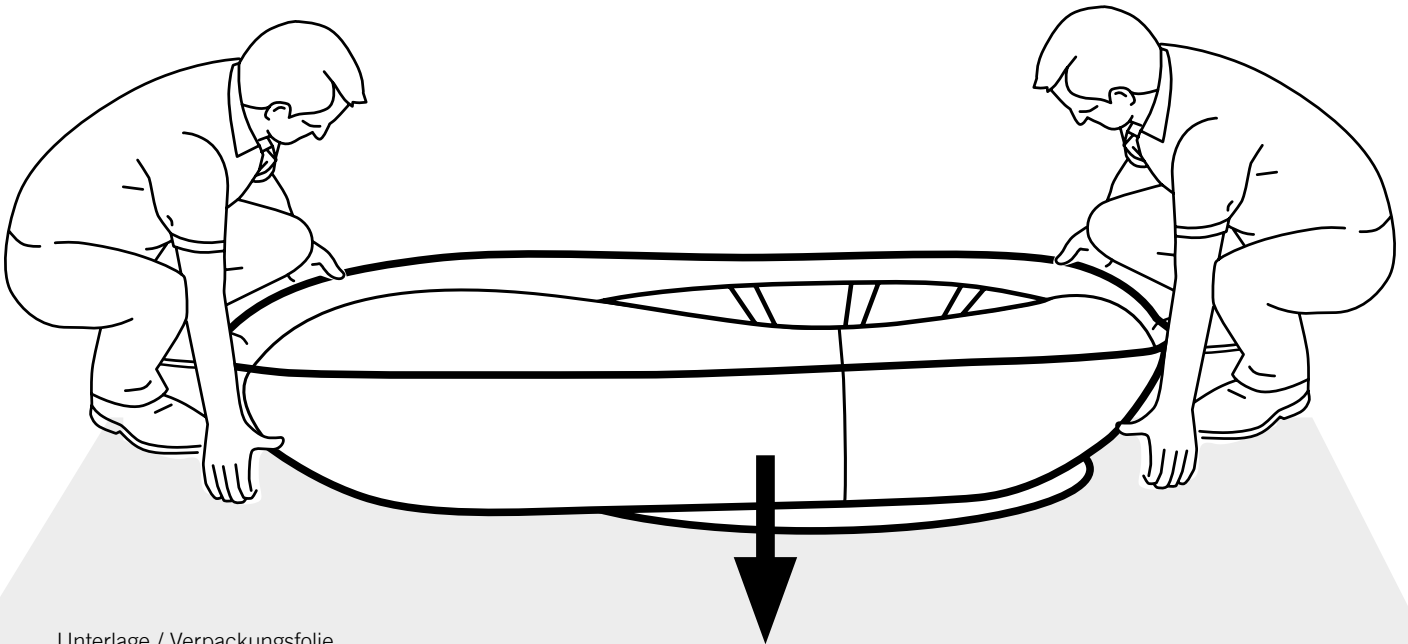

Unterlage / Verpackungsfolie
underlay / packaging foil

5 Montage Sitz / Assembly seat

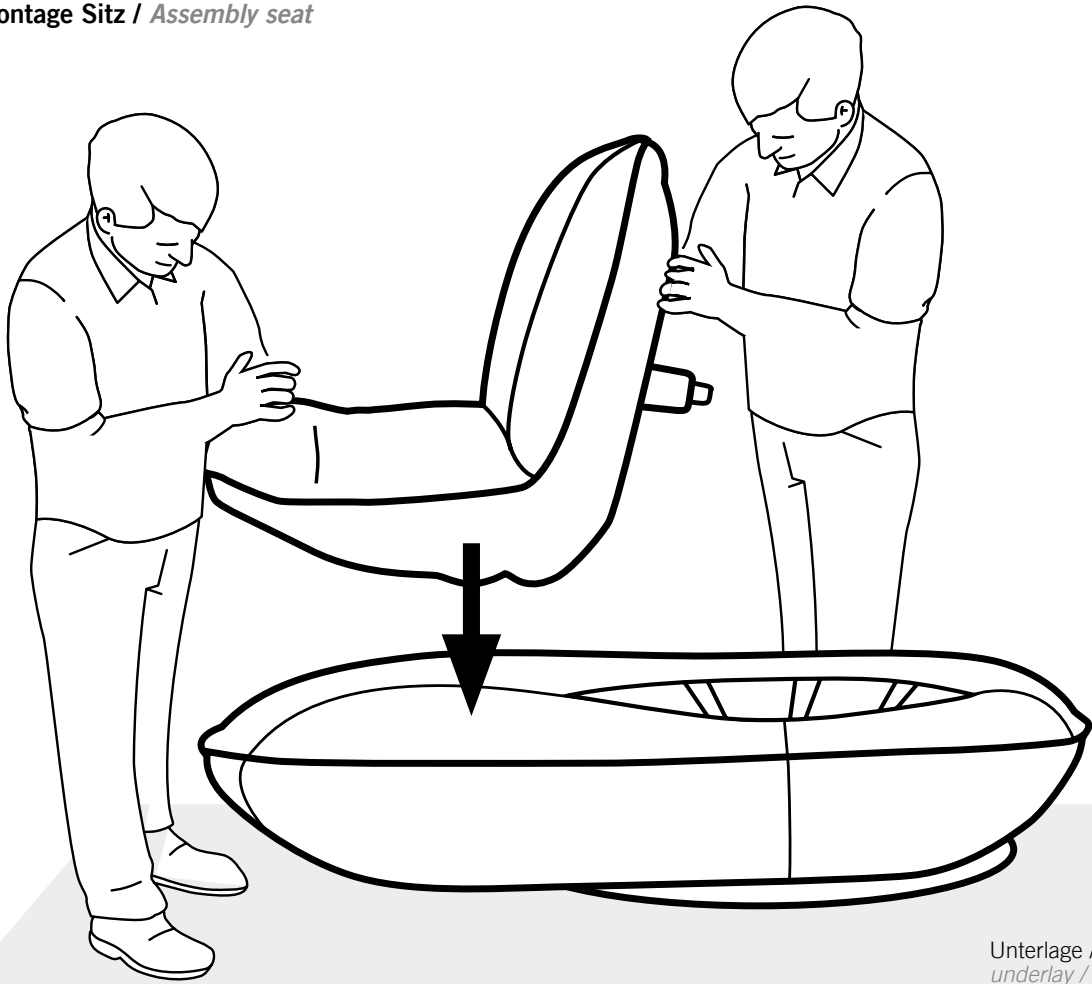

Unterlage / Verpackungsfolie
underlay / packaging foil

6

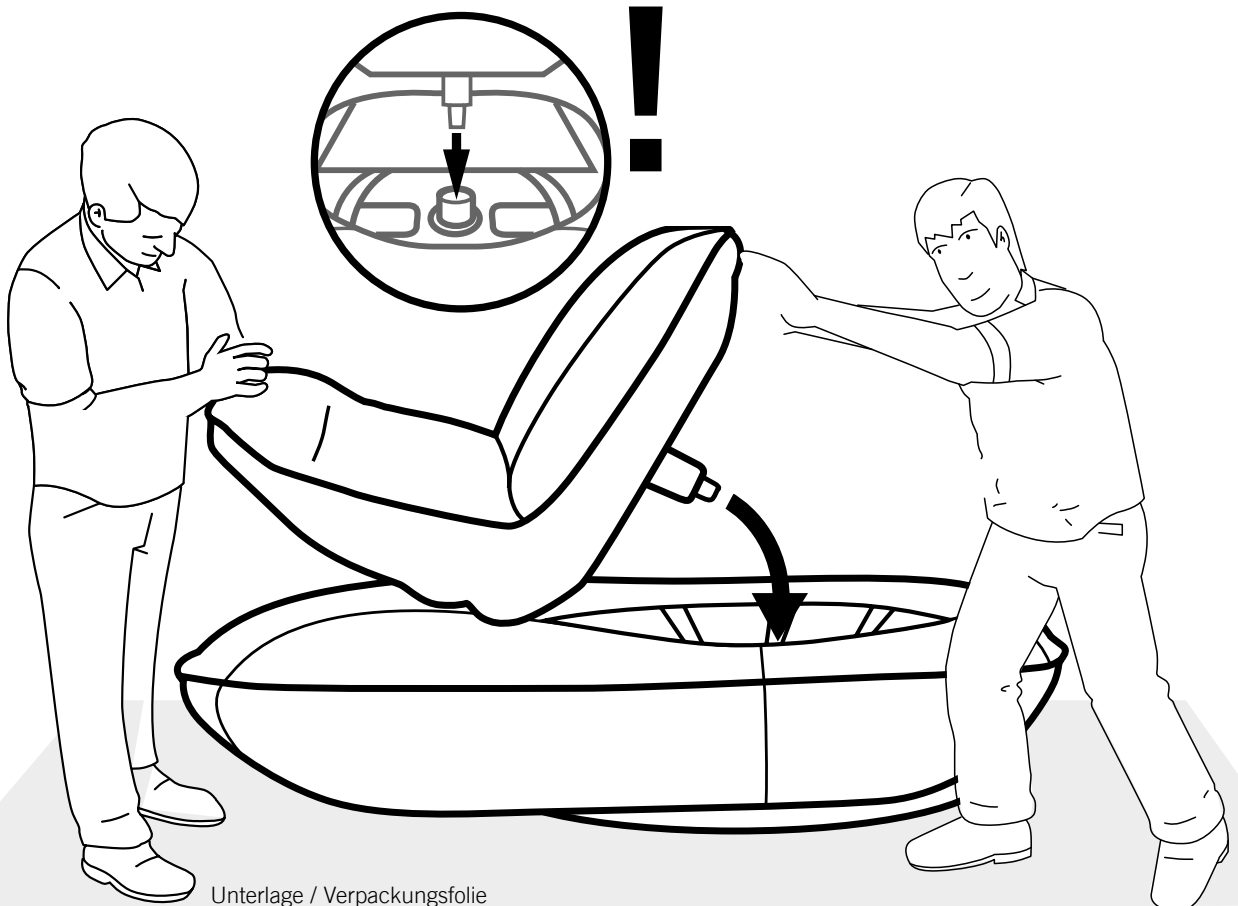

Unterlage / Verpackungsfolie
underlay / packaging foil

7 Montage Tisch (modellabhängig) / *Assembly table (model specific)*

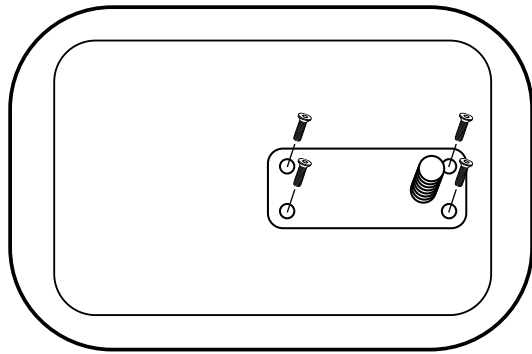

Senkkopfschraube **M6x15**
Countersunk screw **M6x15**

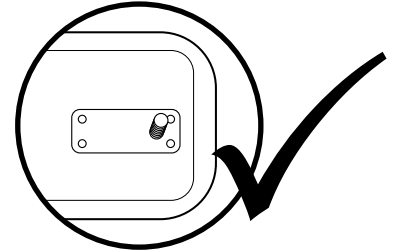
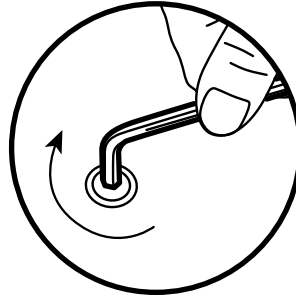
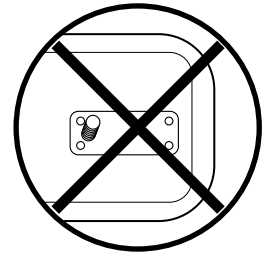

8



! Hinweis / Note:

Bitte Rückenlehne nach hinten klappen. Dies hilft bei der Montage des Tisches.
Please tilt the backrest backwards. This will assist in setting up the table.

! Max. Belastung Tisch
Max. load table
5 kg

10

9

! Hinweis / Note:

- Die Metallhalterung in das Gewinde im Sitz eindrehen, bis sie am Anschlag sitzt.
- Anschließend die Metallhalterung wieder eine Umdrehung lösen.
- Die Tischplatte in die montierte Metallhalterung eindrehen, bis sie fest sitzt.
- Danach die Tischplatte ebenfalls eine Umdrehung lösen.
- *Screw the metal bracket into the thread in the seat until it stops.*
- *Then loosen the metal bracket by one turn.*
- *Screw the tabletop into the mounted metal bracket until it is tight.*
- *Then loosen the tabletop by one turn as well.*

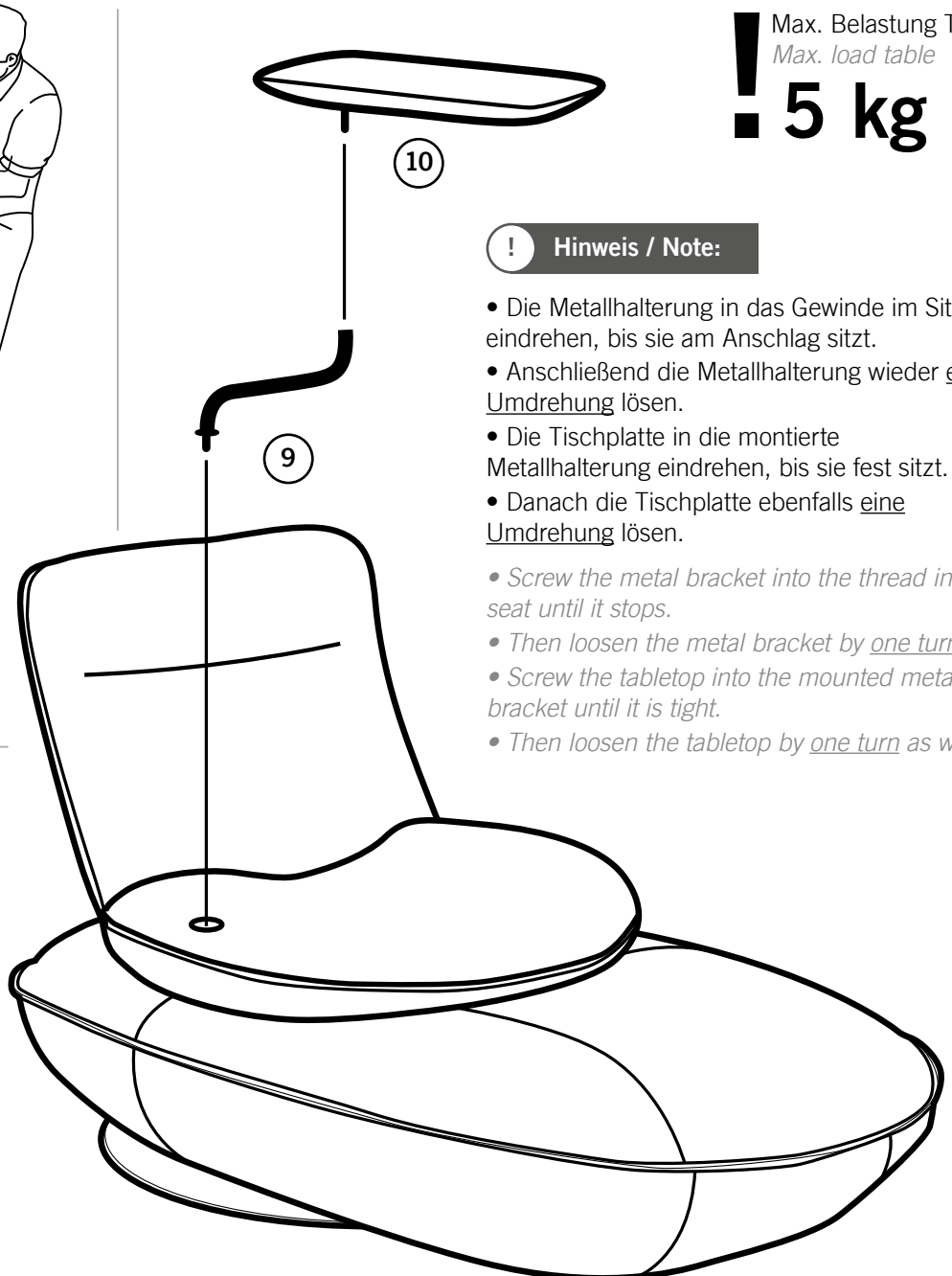

11 Funktionstest / Functional test

modellabhängig / model specific

