

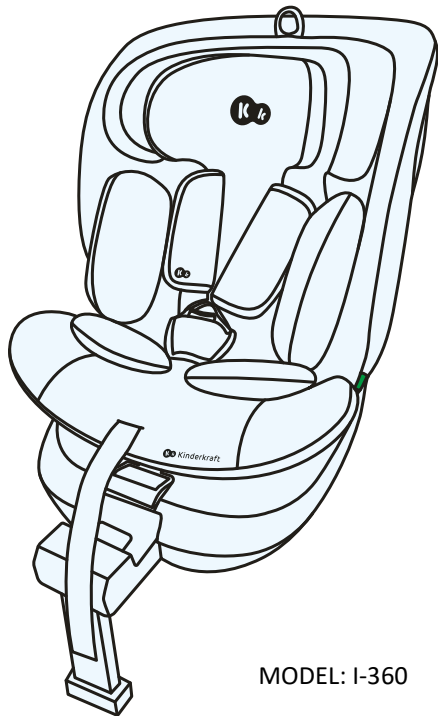

I-360

USER GUIDE



MODEL: I-360 ECE R129.03 v.1.0

NOTE: The product graphics are for illustrative purposes only!

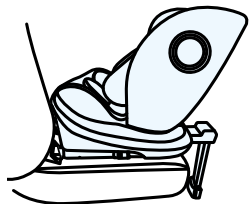

40-105 cm

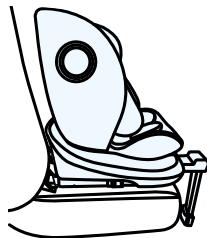

76-105 cm



100-150 cm





1.0 General information

The car seat has been designed, tested, and approved in accordance with the requirements of UN/ECE Regulation No. 129 concerning the approval of child restraint systems (UN/ECE R129/03).

Do not position the car seat forward-facing until the child is 15 months old and 76 cm tall.

The car seat can be installed in the car in the positions indicated by the manufacturer in the vehicle user's manual. It is required to read the vehicle user's manual.

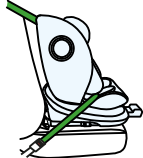
Please refer to the chart on the next page for correct installation instructions.

Child's height	Car seat orientation	Car seat installation
40cm–105cm		ISOFIX + support leg + internal safety harness
76cm-105cm		ISOFIX + support leg + internal safety harness
100cm-150cm		ISOFIX + three-point car seat belt
		three-point car seat belt

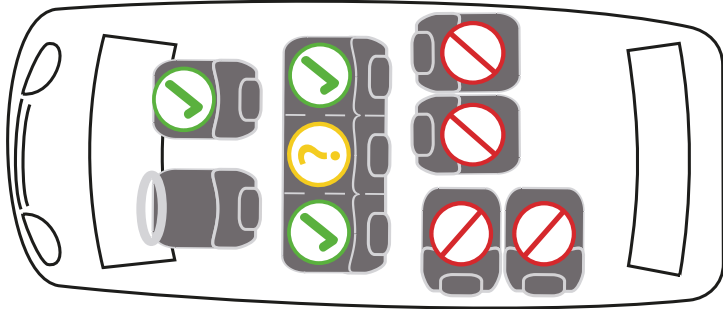

2.0 Safety Instructions

Please take a few minutes to read this instruction manual to ensure proper safety for your child.



- DO NOT install the car seat on rearward facing or side-facing seats in the vehicle.
- DO NOT place the car seat on seats equipped with an active front airbag.



- A car seat can be installed in the middle seat only if the seat is equipped with a three-point car seat belt, ISOFIX connectors and a Top Tether strap.



- If the car seat is installed in the front seat of the vehicle, the front airbag must be deactivated.
- It is recommended to install the seat only in the rear seats of the car.

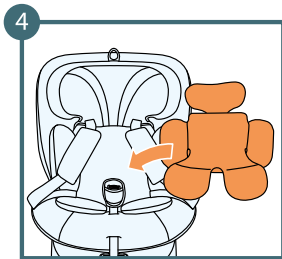
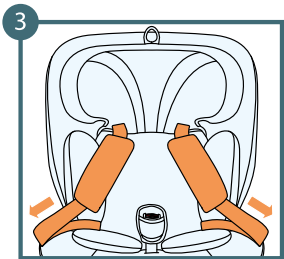
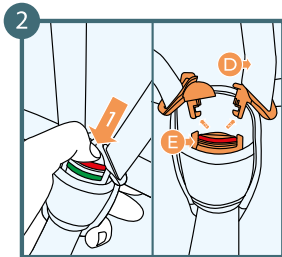
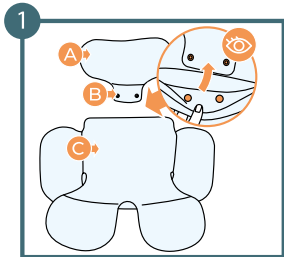

- A: Headrest part of the insert**
- B: Fasteners**
- C: Insert**
- D: Internal safety harness**
- E: Internal safety harness buckle**

3.0 Securing the child

3.1 Installing the insert

Use the additional insert until the child reaches 76 cm.

1. Connect the headrest part of the insert to the rest of the insert with the fasteners
2. Detach the safety harness
3. Move the seat belt to the sides of the car seat
4. Put the insert in place

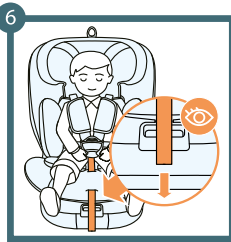
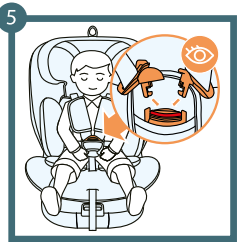
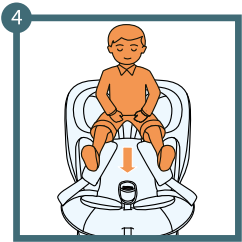
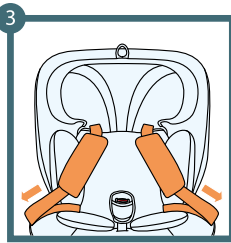
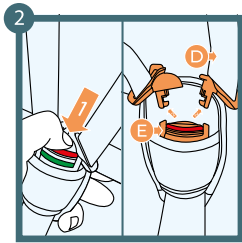
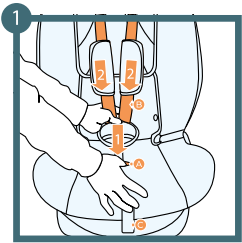

- A: Safety harness adjustment button**
- B: Safety harness**
- C: Safety harness adjuster strap**
- D: Safety harness**
- E: Safety harness buckle**

3.2 Adjusting the safety harness

1. Press the safety harness adjustment button while simultaneously pulling the safety harness to the limit. **Remember: do not pull the shoulder pads.**
2. Unbuckle the safety harness
3. Move the safety harness to the sides of the car seat
4. Place the child in the car seat
5. Fasten the safety harness
6. Adjust the safety harness to the child by pulling the safety harness adjuster strap

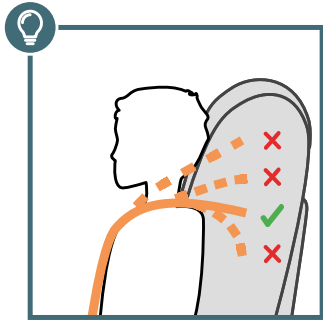

Adjust the height of the shoulder safety harness – it should enter the backrest flat, horizontally, just above the child's shoulders.



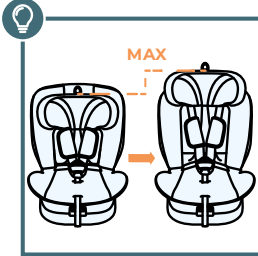
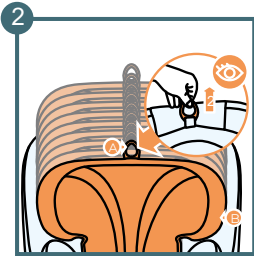
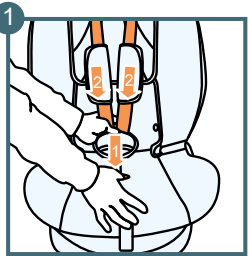

3.3 Headrest height

The headrest should be adjusted to the child's head well, the lower part of the headrest should be positioned at the child's shoulder height.

1. Loosen the harness straps fully by pressing the button and pulling the harness straps **Remember: do not pull the shoulder pads.**
2. Grasp the headrest height adjustment strap, which is located on the top of the headrest, and pull it up gently
3. Adjust the headrest by selecting one of the nine options; when the height is adjusted, let go of the adjustment strap

IMPORTANT: Make sure the seat headrest is locked in place

- A:** headrest height adjuster strap
- B:** headrest

3.4 Backrest angle of incline adjustment mechanism

1. Pull the backrest angle of incline adjustment lever
2. Adjust the seat angle of incline
3. Release the lever in the required position (one of five available options)
4. Move the seat slightly until you hear a distinct "click" sound

NOTE! It is possible to adjust the backrest angle of incline for children with a height of 76-105 cm.

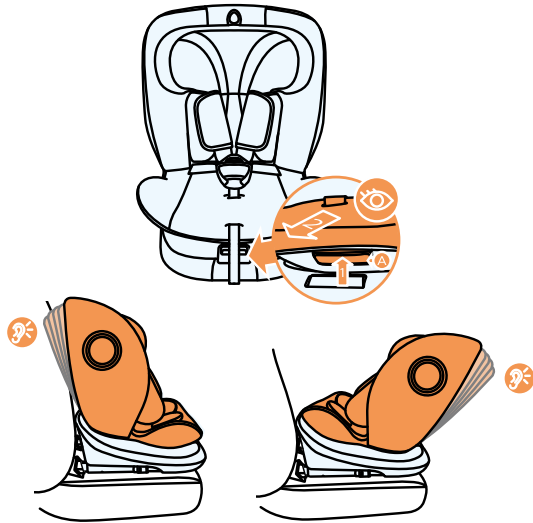

A: Backrest angle of incline adjustment lever

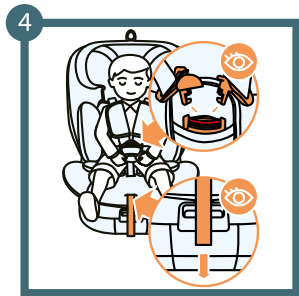
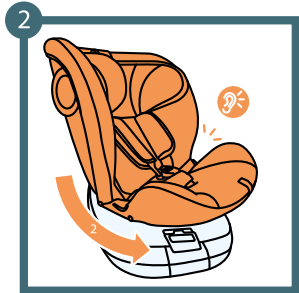
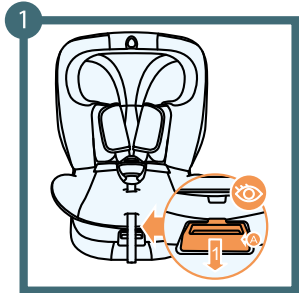

A: Car seat easy spin lever

3.5 Easy spin mechanism

Easy spin mechanism is a function that helps you comfortably place or remove your child from the car seat.

1. Pull the car seat easy spin lever
2. Rotate the car seat to the side of your choice. You will hear a "click" indicating that the car seat is locked in the selected position
3. Place your child in the car seat
4. Secure the child with the safety harness

IMPORTANT! For safety reasons, when the support leg is not fully extended from the car seat base, the car seat locks, and it is not possible to rotate it.

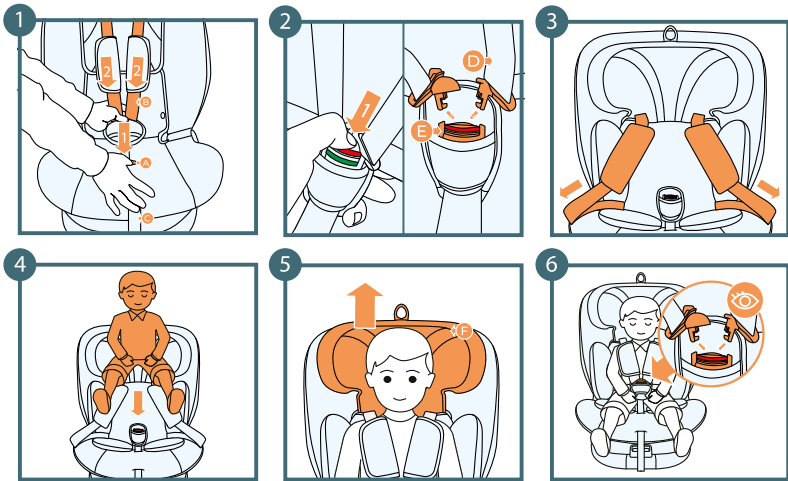

3.6 Securing the child with the internal safety harness

1. Loosen the safety harness fully by pressing the button and pulling the harness straps **Remember: do not pull the shoulder pads.**
2. Unfasten the buckle
3. Place the safety harness on the sides of the car seat
4. Place the child in the car seat
5. Adjust the headrest to the child's height
6. Fold the two buckle latches together to interlock and insert them into the buckle until you hear a "click"

- A:** Safety harness adjustment button
- B:** Safety harness
- C:** Safety harness adjuster strap
- D:** Safety harness
- E:** Safety harness buckle

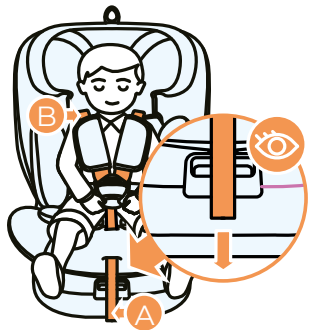

A: Safety harness adjuster strap
B: Safety harness

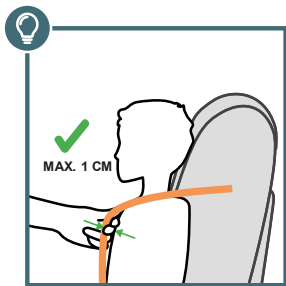
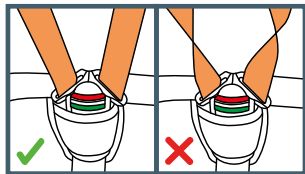

3.7 Tightening the safety harness

1. Pull the internal safety harness to eliminate the clearance in the waist section, the safety harness should lie flat.
2. Tighten the safety harness with the adjuster strap until the safety harness lies flat on the child's body.



IMPORTANT! Make sure the safety harness is not twisted. Ensure that the straps are tightened so that there is no more than 1cm of slack between them and the child.

4.0 Installation in the vehicle

4.1 Rearward facing installation of the car seat for children between 40 and 105 cm (from 0 and approximately 4 years old) using the ISOFIX system and the support leg.

IMPORTANT! The vehicle manual provides the location of the ISOFIX attachment points and other necessary information for installing the car seat in the car. The user must necessarily read the vehicle manual.

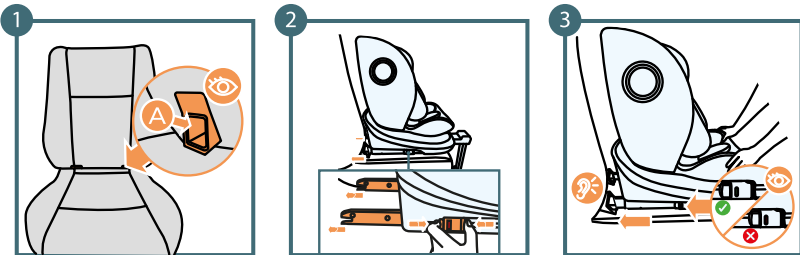

A: ISOFIX arms/ connectors of the car seat

4.1.1 Installation using the ISOFIX system

Before placing the car seat in the car, unfold the support leg.

1. Attach the ISOFIX pads to the seat connectors in the vehicle.
2. Place the car seat together with the unfolded support leg on the seat in the vehicle. Press both sides of the ISOFIX release button and extend the ISOFIX connector arms to their maximum length.
3. Grasp the car seat with two hands and slide both latches into the mountings in the vehicle seat. When you hear the "click" of each ISOFIX latches, push the car seat against the backrest by applying firm, even pressure on both sides.

NOTE! The locking latches are only properly attached when both button indicators are completely green.

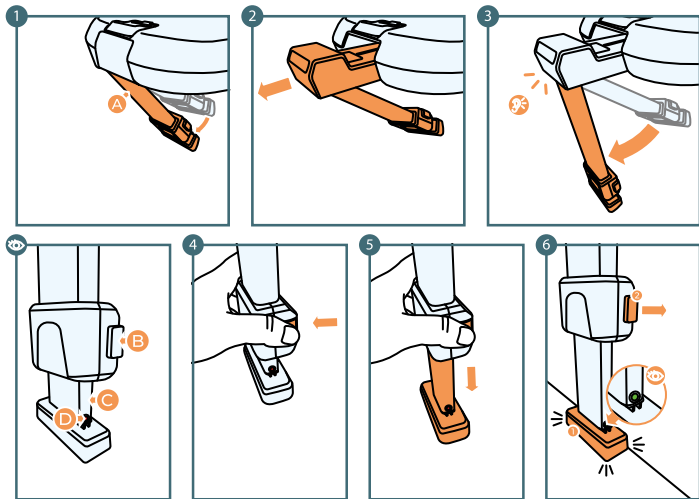

- A: Support leg base**
- B: Support leg height adjustment buttons (on both sides of the leg)**
- C: Support leg extension**
- D: Support leg correct installation indicator**

4.1.2 Installing the support leg

1. Pull the support leg of the car seat out of the base
2. Pull the upper part of the leg towards you
3. Fully unfold the leg until you hear a "click"
4. Press the leg height adjustment buttons on both sides of the leg (this will release the leg height lock, and the leg will automatically extend)
5. Adjust the leg height – it should be pressed firmly against the floor
6. Release the buttons

The support leg is installed correctly, if, after taking these steps the car seat is right in place and the correct installation indicator is green.



- **NOTE!** Never install the support leg on the storage box in the floor of the car - the storage box can break during an accident; if in doubt, refer to the vehicle manual.
- **NOTE!** The support leg must never be unsupported, and no objects can be placed under it.
- **IMPORTANT!** The support leg shall support the car seat – it shall not lift the bottom part of the I-360 seat above the level of the seat of the vehicle.

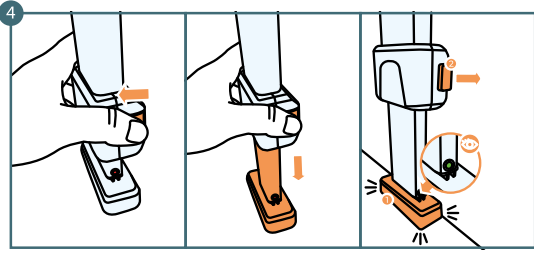
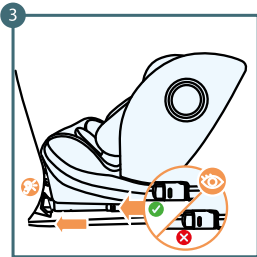
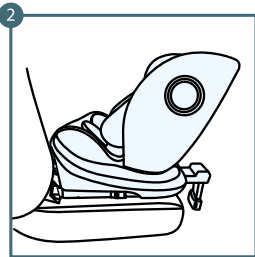
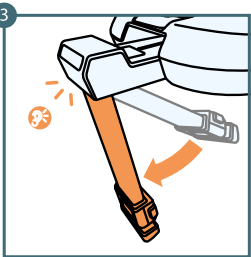

4.2 Forward facing installation of the car seat for children between 76 and 105 cm using the ISOFIX system and the support leg.

1. Unfold the stabilizing leg- you will hear a "click" when unfolded.
2. Place the car seat on the seat of the vehicle
3. Connect the ISOFIX latches with the vehicle mountings
4. Push the car seat easy spin lever and turn the seat forward facing (you will hear a "click" indicating that the car seat is locked in the correct position) Press the support leg height adjustment button and hold until the leg extends (adjust the height of the leg – it should stand firm on the floor).

A: Support leg

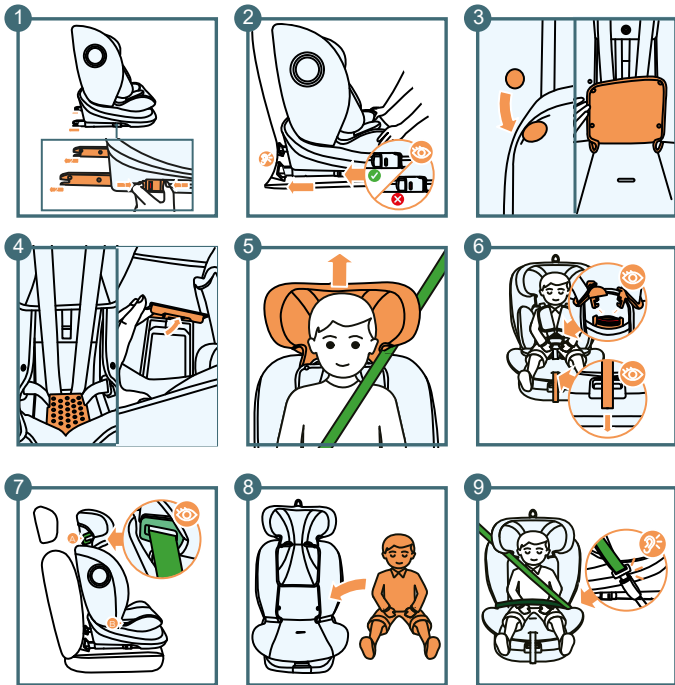

4.3 Forward facing installation of the car seat for children between 100 and 150 cm using the three-point car seat belt.

1. Install the car seat on the seat of the vehicle using the ISOFIX connectors (forward-facing).
2. Push the car seat as far as possible into the seat and check for correct installation - the installation indicators should turn green.
3. Unfasten the fasteners and uncover the car seat backrest
4. Open the car seat cover and fasten the internal safety harness inside the seat.
5. Place the child in the car seat
6. Adjust the headrest to his/her height.
7. Guide the shoulder belt through the green shoulder belt guide.
8. Guide the car seat belt through both lap belt guides. Fasten the car seat belt. You will hear a characteristic "click".



A: Internal safety harness buckle
B: Safety harness
C: Buckle pad
D: Shoulder pads

E: Headrest adjustment lever
F: Headrest
G: Fasteners
H: Back part of the cover
I: Safety harness storage compartment

5.0 Stowing away the five-point safety harness

1. Loosen the safety harness fully by pressing the button and pulling the safety harness. **Remember: do not pull the shoulder pads.**
2. Remove the shoulder pads and buckle pad by unfastening the fasteners
3. Place the headrest in the highest position
4. Unfasten the buckle
5. Put the buckle through the opening in the cover
6. Unfasten the fasteners and uncover the car seat backrest
7. Open the storage cover
8. Fasten the five-point safety harness
9. Put the fastened safety harness into the storage compartment so that it lies flat along the backrest
10. Put the cover back on the car seat using the fasteners on the edges of the fabric.
11. Adjust the headrest to the child's height.

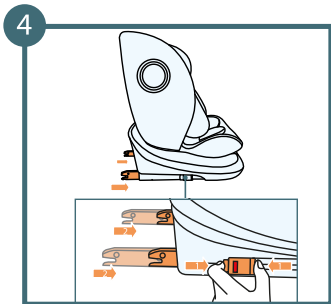
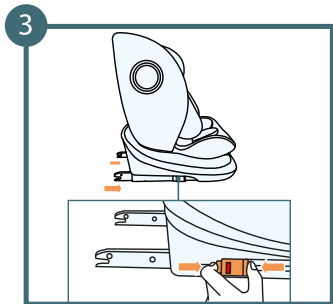
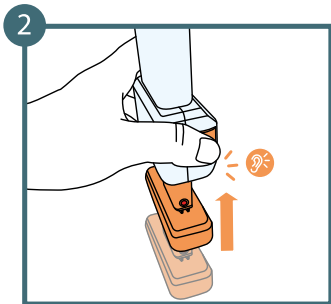
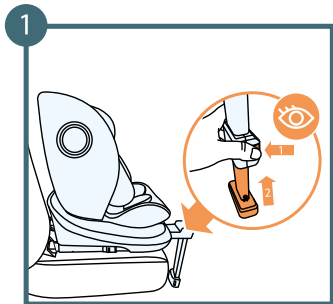

5.1 Removing the car seat (ISOFIX system + support leg)

1. Fold the support leg extension by holding the two buttons on the sides of the leg extension and push it up by retracting it into the other part of the leg. You will hear a "click" which indicates that the leg has been retracted.
2. Grasp the foot and slide it back into the support leg.
3. Press the release button located on both ISOFIX latches. (The latches will be released and the colour of the ISOFIX indicators will change from green to red)
4. Slide the ISOFIX latches into the car seat using the sliding lever

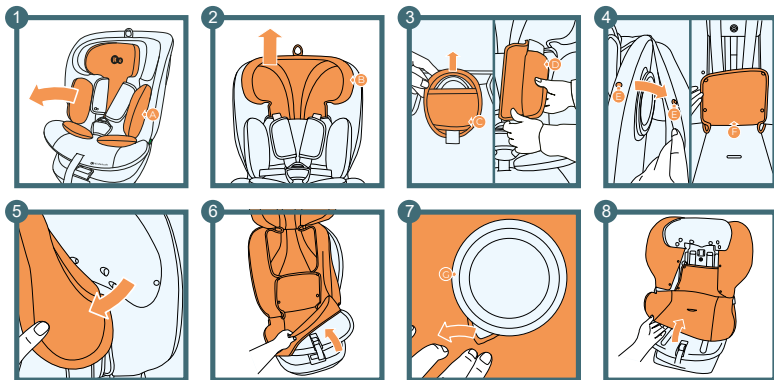

- A: Insert**
- B: Headrest**
- C: Buckle pad**
- D: Shoulder pad**
- E: Fasteners**
- F: Front part of the car seat backrest cover**
- G: Side protection**

5.2 Removing the cover

1. Remove the insert
2. Move the headrest to the highest position
3. Remove the shoulder pads and buckle pad
4. Unfasten four fasteners securing the cover to the front part of the car seat backrest and the fasteners on the sides of the car seat
5. Remove the fabric from the headrest starting from the sides
6. Starting from the bottom of the car seat, carefully remove the cover
7. Pull out the fabric around the side protection elements
8. Remove the entire fabric by putting it over the top part of the car seat

5.3 Installation of the cover

To reinstall the cover, simply reverse the above sequence of steps. Adjust the cover to the installation points on the car seat. Start by installing the cover on the car seat shell and finally on the headrest section.

6.0 Cleaning

NOTE: Do not use the car seat without the cover.

- The cover can be removed and washed using mild powder and delicate wash cycle (30°C).
- Follow the washing instructions on the cover label. Colours may fade if washed at temperatures above 30°C.
- Do not spin or tumble dry the cover (the layers of material may split).
- Prolonged sun exposure of the cover is prohibited.
- Plastic parts can be cleaned with soapy water.
- Do not use aggressive cleaning agents (such as solvents).
- The safety harness can be cleaned in lukewarm soapy water.

Warning! Metal snaps should never be removed from the safety harness.

Full Warranty Terms and Conditions are available at
WWW.KINDERKRAFT.COM



(AR) بضمان مصلحة عملائنا. نحن في خدمتكم! إذا كانت لديكم أي مشكلة مع المنتج الذي حصلتم عليه، فيجربى الاتصال بنا بالطريقة التي تفضلونها!

(CS) V zájmu péče o naše klienty - jsme rádi k dispozici! Pokud jste se setkali s nějakým problémem v souvislosti s obdržným výrobkem, kontaktujte nás způsobem, který vám nejlépe vyhovuje!

(DE) In Sorge für unsere Kunden - stehen wir gerne zu Ihrer Verfügung! Wenn Sie auf ein Problem mit dem erhaltenen Produkt treffen, treten Sie bitte mit uns in Kontakt in der bequemsten Weise für Sie!

(EN) In the interests of our Clients - we are at your disposal! If you have a problem with the product you received, contact us in the most convenient way for you!

(ES) ¡Por el bien de nuestros clientes, estamos a su disposición! ¡Si tiene cualquier problema con el producto recibido, póngase en contacto con nosotros de forma más cómoda para usted!

(FR) Dans l'intérêt de nos clients - nous sommes à votre disposition! Si vous avez un problème avec le produit que vous avez reçu, Contactez-nous de la manière la plus pratique pour vous!

(HU) Bármikor állunk az ügyfeleink rendelkezésére! Ha az átvett termékkel kapcsolatban valamilyen problémába ütközött, az Önnek legmegfelelőbb módon vegye fel velünk a kapcsolatot!

(IT) Prendersi cura dei nostri Clienti - siamo alla Vostra disposizione! Se hai incontrato un problema con il prodotto che hai ricevuto. Contattaci nel modo piu conveniente per te!

(NL) In het belang van onze klanten - staan wij ter beschikking! Als u een probleem met het ontvangen product tegenkomt, neemt contact met ons op via de manier die u het makkelijkste vindt!

(PL) W trosce o naszych Klientów - jesteśmy do dyspozycji! Jeśli napotkałeś problem dotyczący otrzymanego produktu, skontaktuj się z nami w najbardziej dogodny dla Ciebie sposób!

(PT) Para o conforto dos nossos Clientes - estamos sempre à sua disposição! Se tiver qualquer problema com o nosso produto, entre em contacto conosco de modo mais confortável para si!

(RO) In interesul clienților noștri - suntem la dispoziția dumneavoastră! Dacă aveți o problema cu produsul pe care l-ați primit, contactați-ne în modul cel mai convenabil pentru dvs.!

(RU) заботясь о наших клиентах, мы находимся в вашем распоряжении. Если вы столкнулись с проблемой, связанной с полученными продукто, свяжитесь с нами наиболее удобным для вас способом!

(SK) Náš zákazník je pre nás dôležitý - sme vám k dispozícii! Ak máte akýkoľvek problém súvisiaci s doručeným produktom, kontaktujte nás spôsobom, ktorý vám najviac vyhovuje!

(SV) I våra kundens intresse - vi står till ditt förfogande! Om du har problem med den produkt du fick, kontakta oss på det mest praktiska sättet för dig!

International contact:

support@kinderkraft.com

+44 20 4525 0748



kinderkraftofficial



kinderkraft



kinderkraftofficial

منتج / VÝROBCE / HERSTELLER / MANUFACTURER / FABRICANTE / FABRICANT /
GYARTÓ / FABBRICANTE / FABRIKANT / PRODUCTENT / FABRICANTE / PRODUCĂTOR /
ПРОИЗВОДИТЕЛЬ / VÝROBCA / TILLVERKARE:

**4Kraft Sp. z o.o. ul. Tatrzańska 1/5
60-413 Poznań, Poland**