

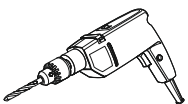

Modell: **PETE**

Art. Nr. 14160015/02

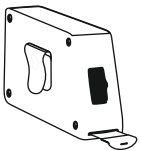
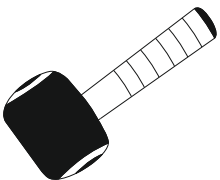
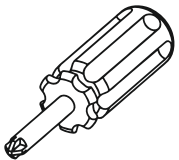
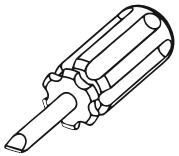

Ø8

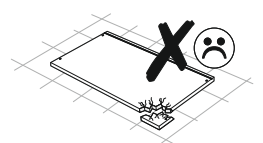
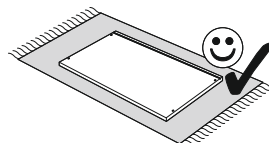
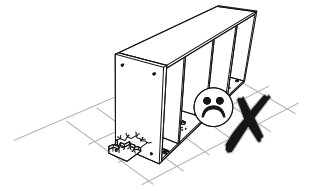
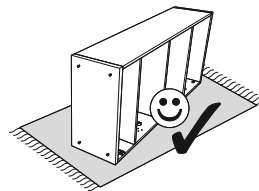
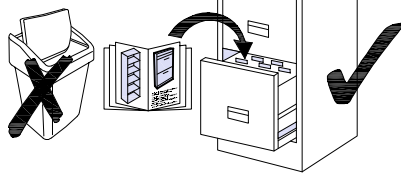
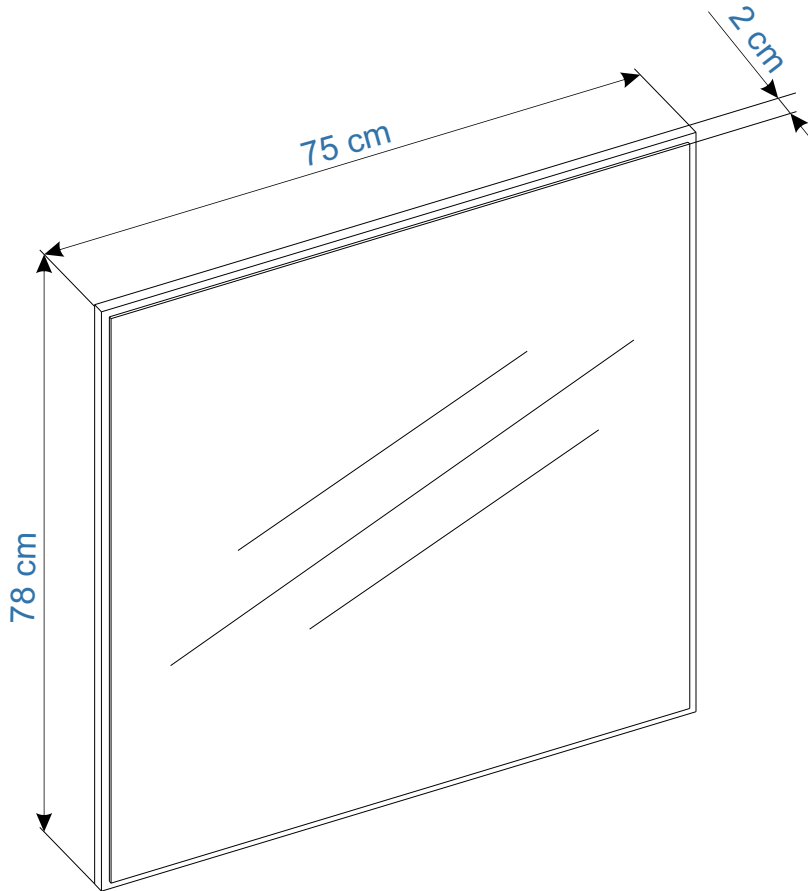

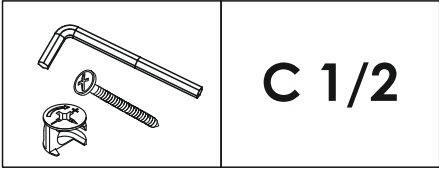

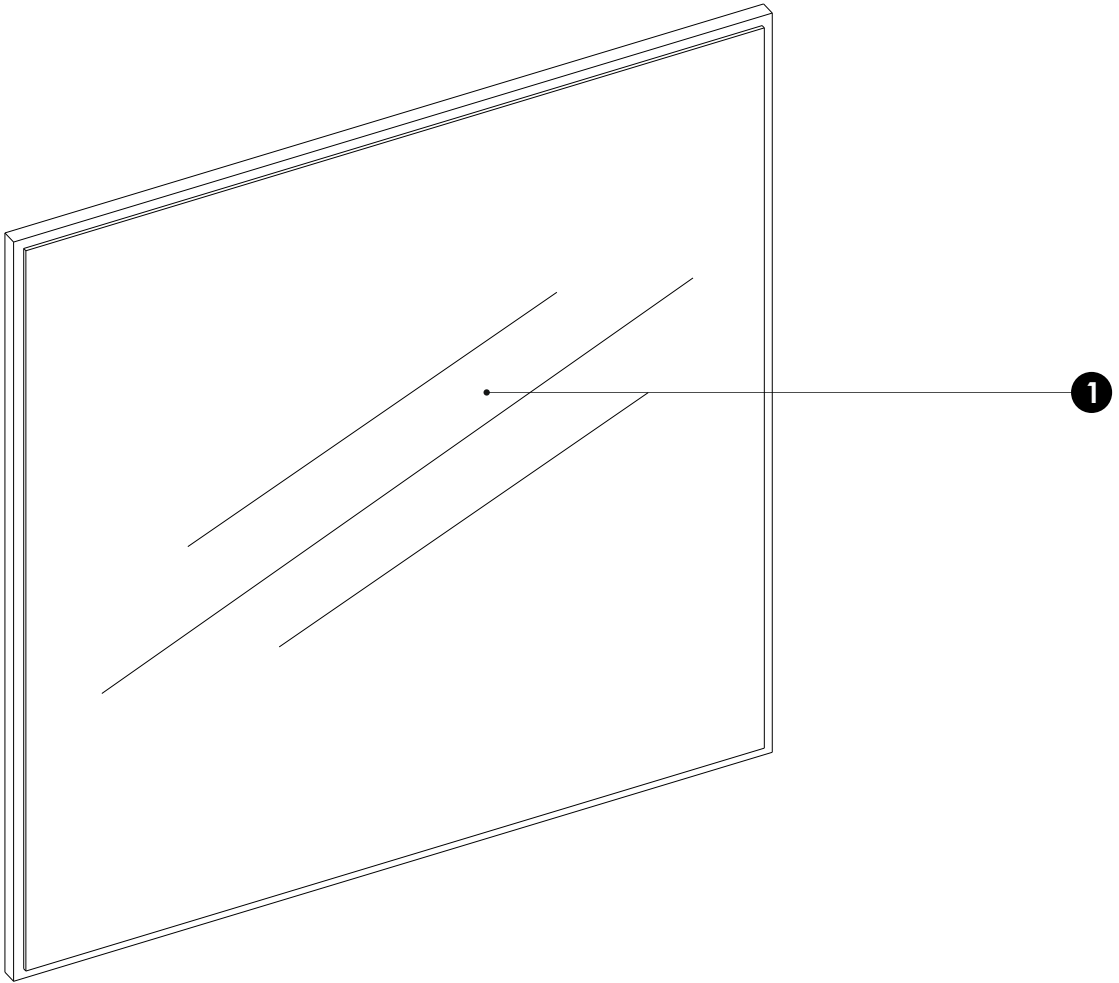

1	780	750	19	x1	1/1
----------	-----	-----	----	----	-----

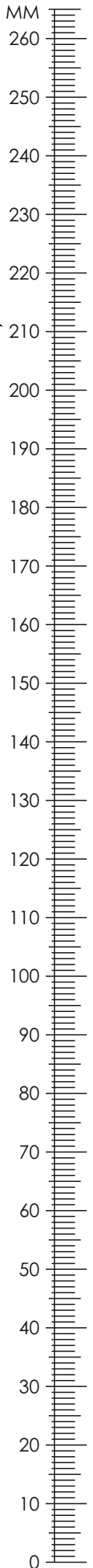
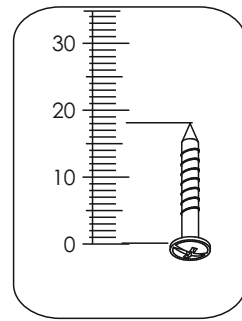

PETE Art. Nr. 14160015/02

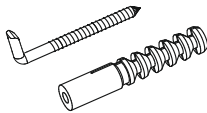

A	B12 8x 40 	x2	Q 1.5x 7 	x4

