

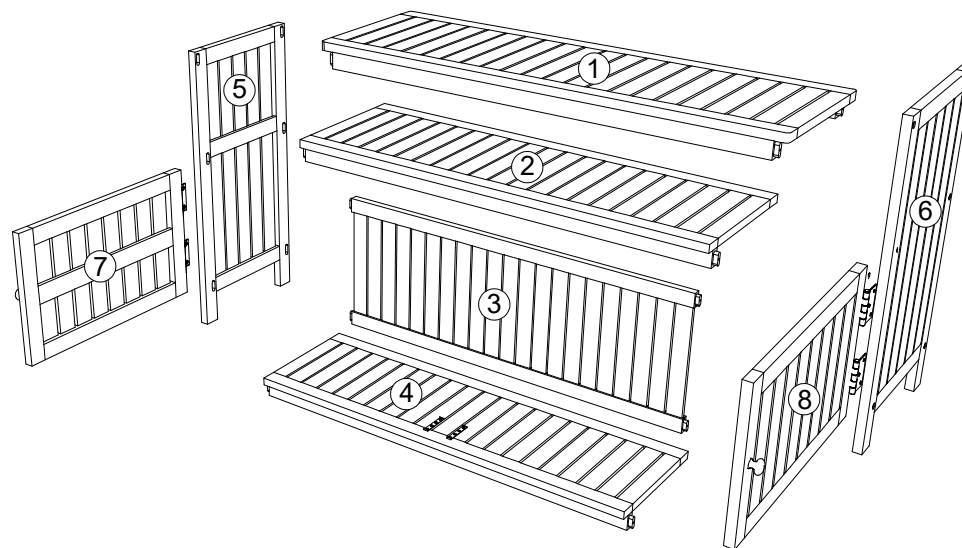

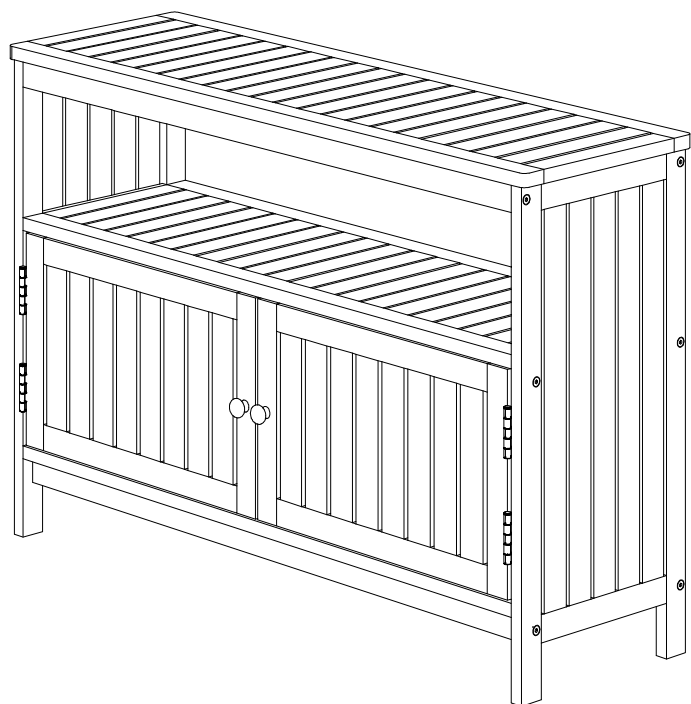



20140281-01

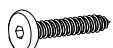

<b>A</b> 	<b>B</b> 	<b>C</b> 	<b>D</b> 	<b>E</b> 	<b>F</b> 
Allen key(2pcs)	ScrewM6x45(12pcs)	ScrewM4x15(12pcs)	Bolt M6x30 (2 pcs)	Handle (2 pcs)	Rebound device (2 pcs)

Step 1:

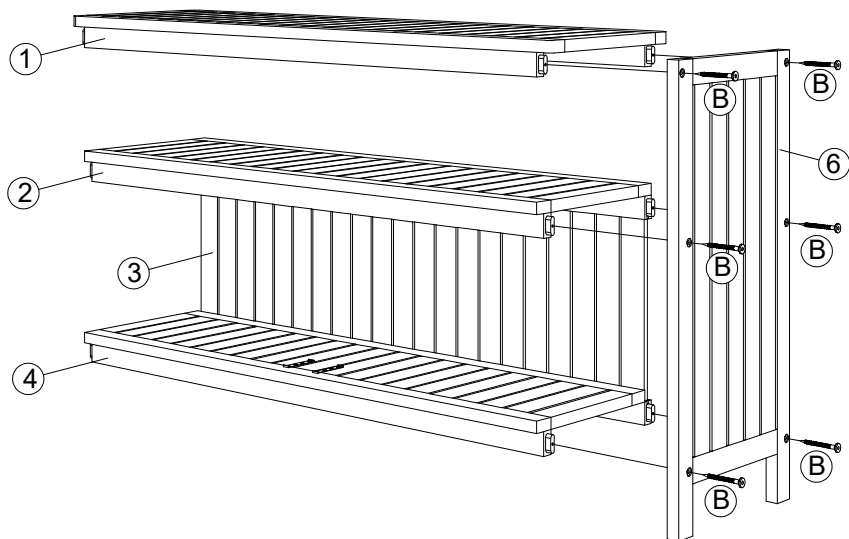

Step 2:

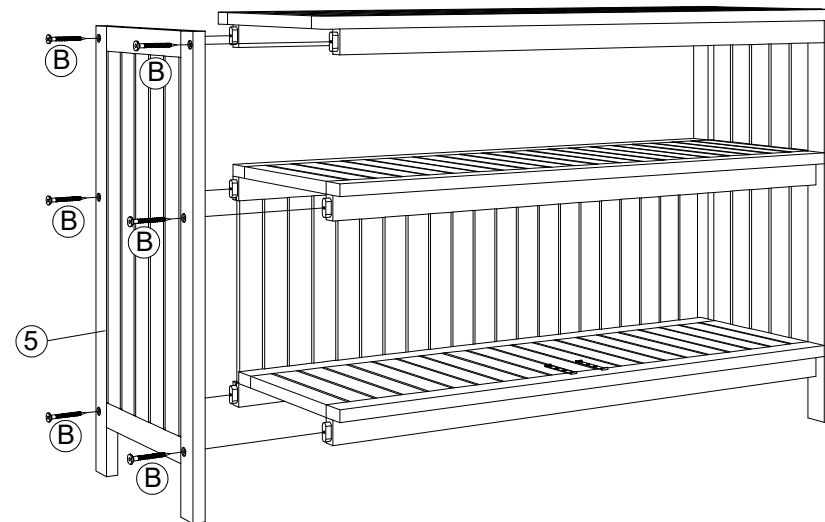

20140281-01

Step 3:

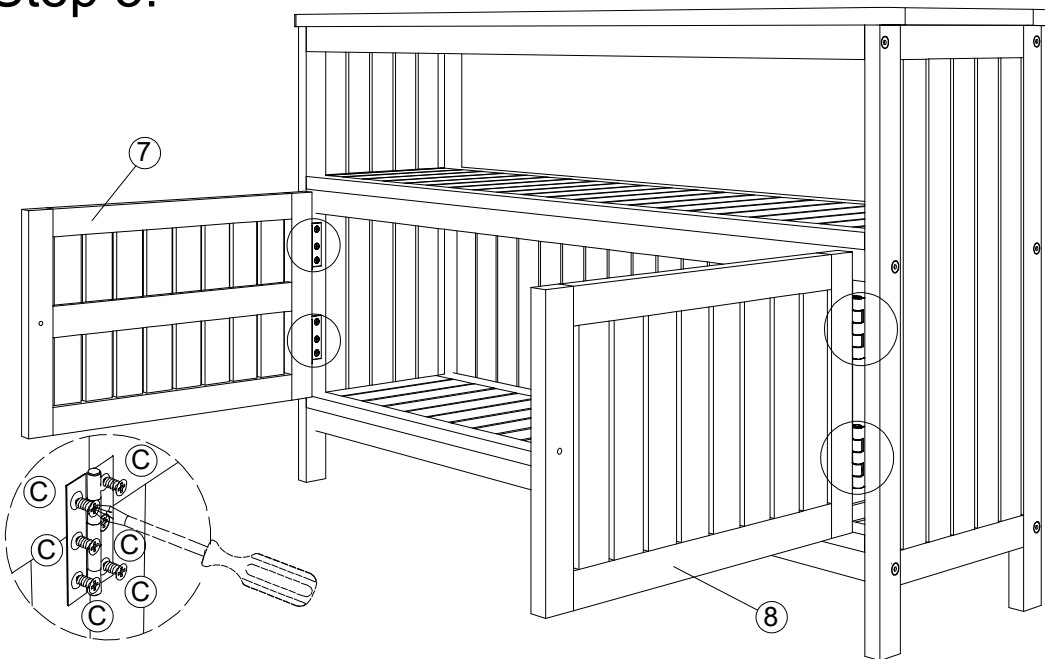

Step 4:

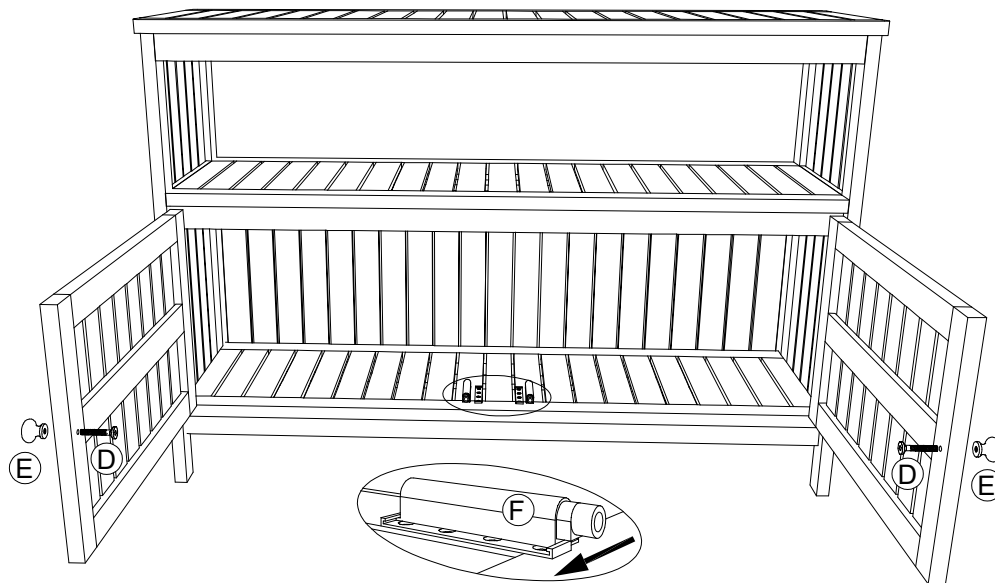

Step 5:

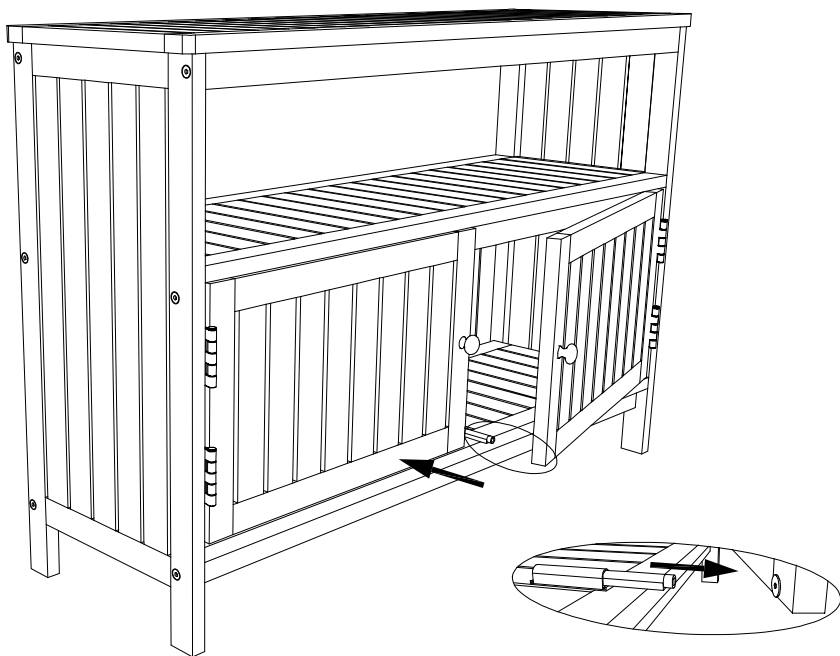

Step 6:

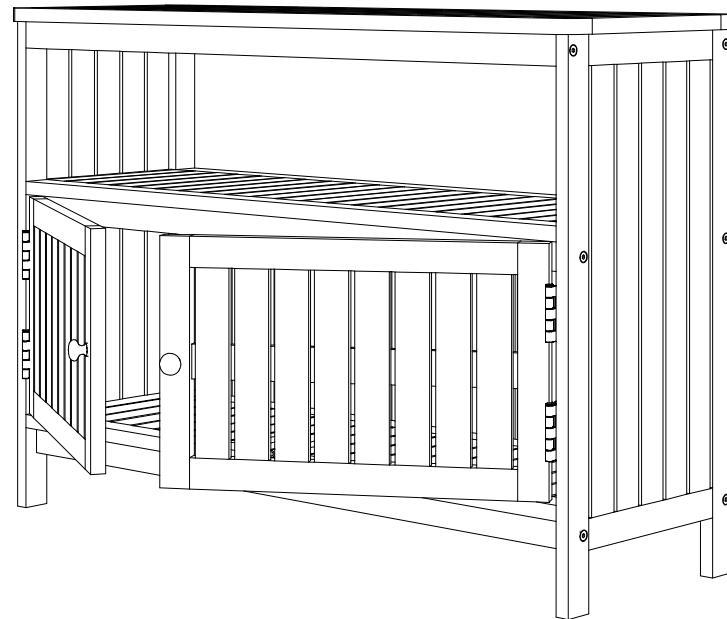

FINISHED