

Art. Nr.	<b>ASI20T12</b>	<b>Service</b>	25.03.2024.
Name	<b>ASINARA</b>		
Typ	<b>T 12 - KOMBI-VITRINE</b>		

- ① 936×365×19      ⑳ 536×15×10
- ② 936×365×19
- ③ 2020×372×66
- ④ 2020×372×66
- ⑤ 2020×329×19
- ⑥ 337×325×18
- ⑦ 337×290×18
- ⑧ 537×325×18
- ⑨ 335×290×18
- ⑩ 533×295×5
- ⑪ 535×290×18
- ⑫ 2012×296×20
- ⑬ 332×496×20
- ⑭ 904×494×4
- ⑮ 836×496×20
- ⑯ 2036×910×3
- ⑰ 535×892×4
- ⑱ 60×60×15
- ⑲ 336×15×10

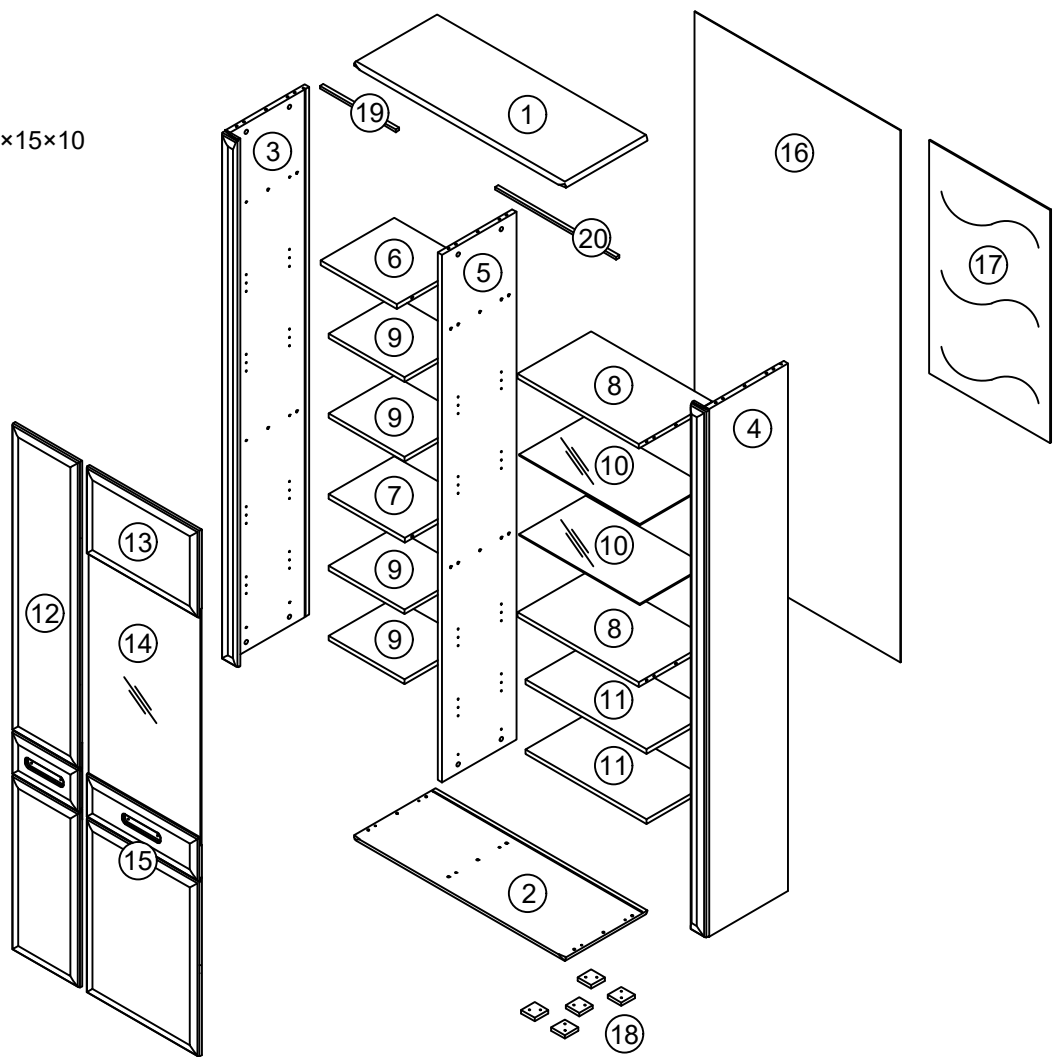

<b>OPTION</b>	
005062ZB_BEL.  x1	005091ZB Mem.Funk  x1

<b>D1</b> Ø8x32 mm 	<b>EX</b> Ø15x12 mm 	<b>S2-16L</b> 4x16 mm 	<b>C2</b> 	<b>GL</b> 	
<b>T1</b> 	<b>W1</b> 	<b>S-25</b> 3,5x25 mm 	<b>A2</b> 77x20x15 mm 	<b>PC</b> Ø7/9x4mm 	
<b>B</b> 	<b>W3</b> 	<b>S-16</b> 3,5x16 mm 	<b>M20</b> M4x20 mm 	<b>S2-30</b> 4x30 mm 	
<b>ST</b> 	<b>PG</b> 128 mm 	<b>S2-16</b> 4x16 mm 	<b>ZR</b> 	<b>D9</b> 0mm 	<b>M1</b> 

Modellname: **ASINARA**

# MONTAGEANLEITUNG

## TYPE T12 - KOMBI-VITRINE

# 1/2



2 Persons

20  
Min.

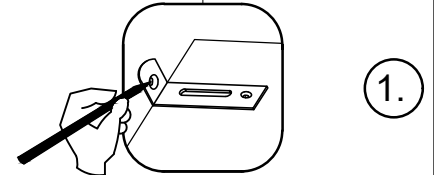
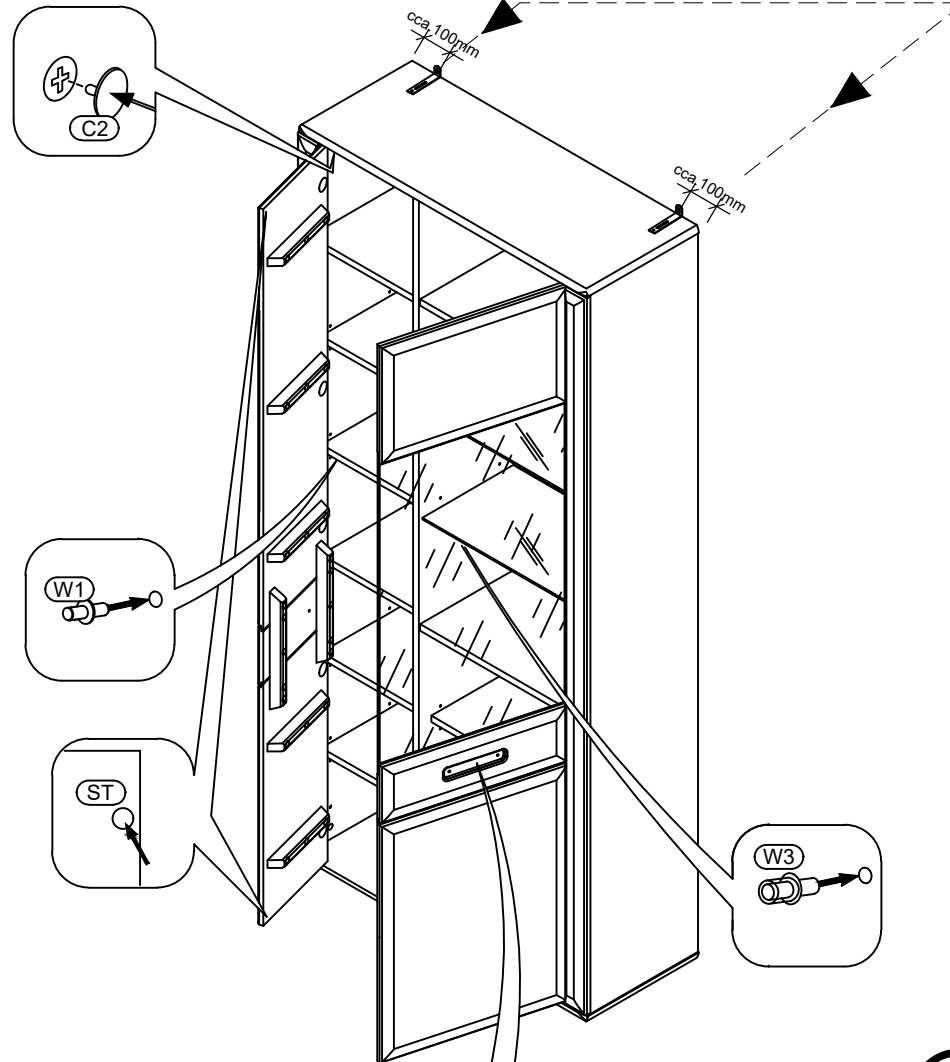
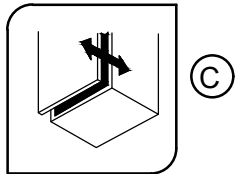
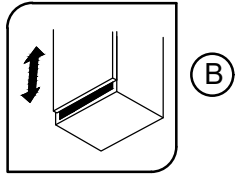
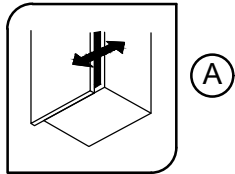
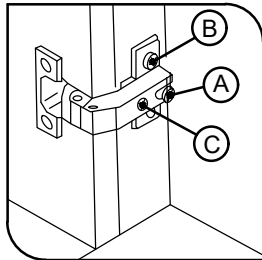
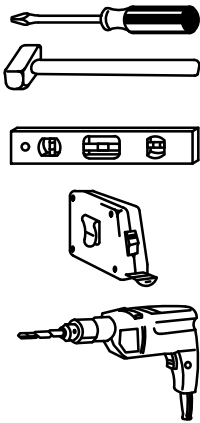

1.

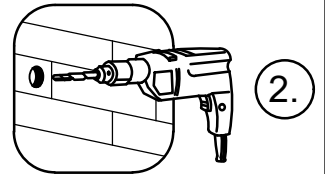

2.

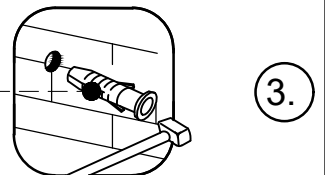

3.

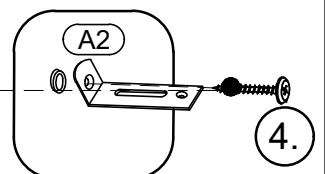

4.

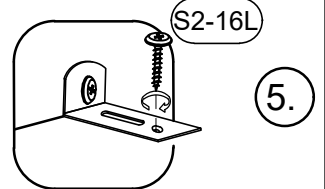

5.

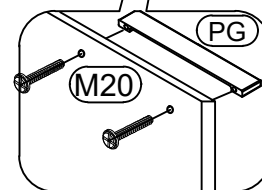
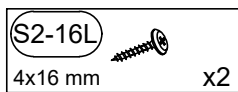
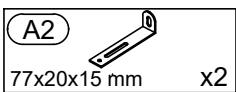
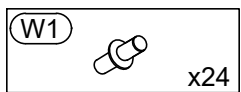
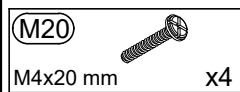
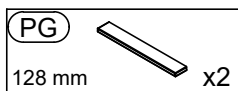
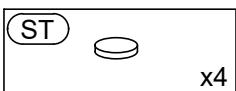
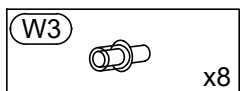
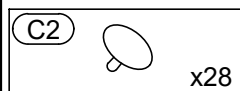

Modellname: **ASINARA**

# MONTAGEANLEITUNG

## TYPE T12 - KOMBI-VITRINE

# 2/2

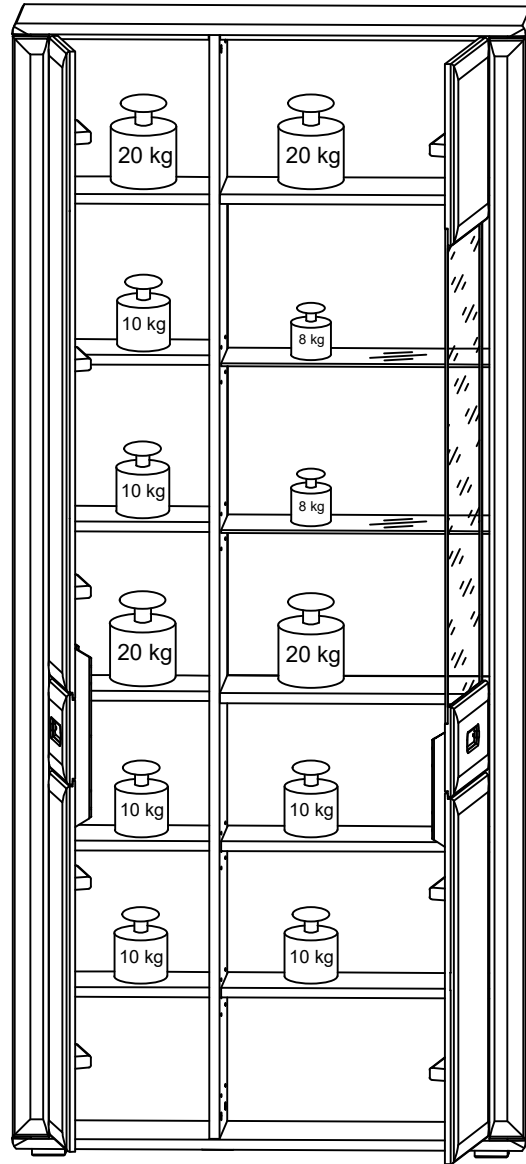

Modellname: **ASINARA**

# *OPTIONAL* BELEUCHTUNG

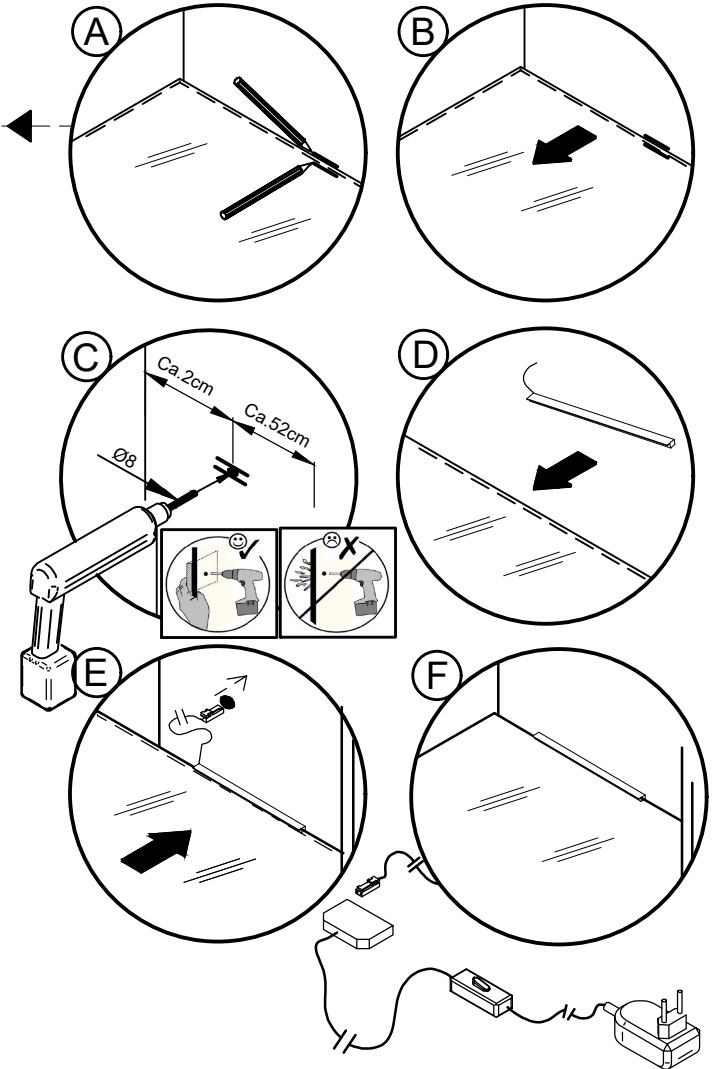
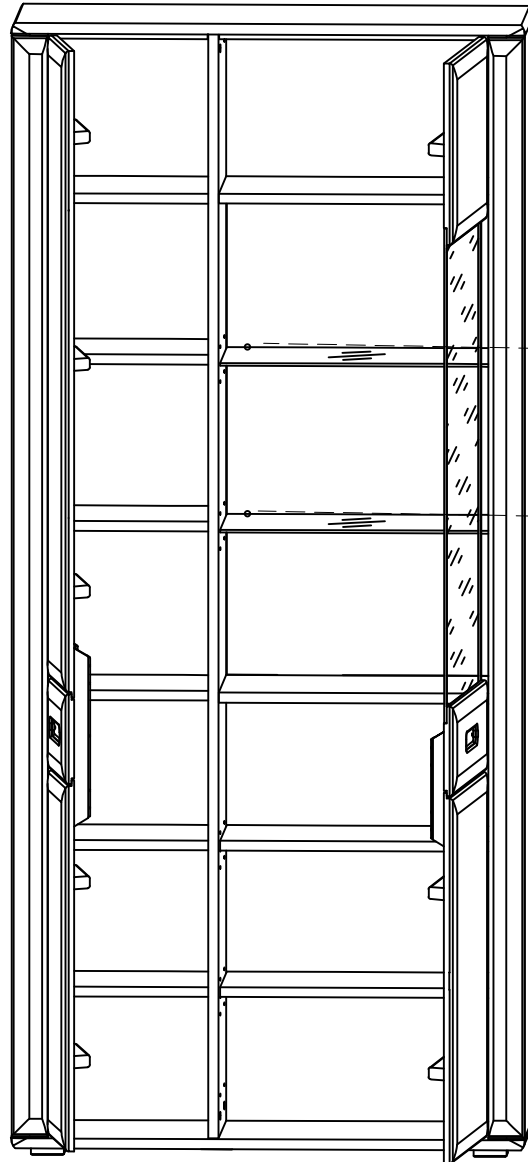

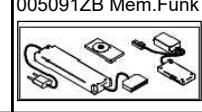
<b>OPTION</b>	
005062ZB_BEL.  x1	005091ZB Mem.Funk  x1