

WICHTIG – FÜR SPÄTERE VERWENDUNG AUFBEWAHREN- SORGFÄLTIG LESEN

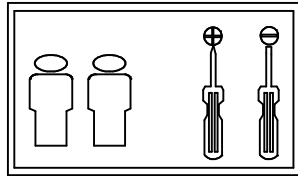

Schardt GmbH & Co. KG
 Am Riegel 15
 96268 Mitwitz
 Tel. 09266/9907-0
 Fax 09266/9907-77
 eMail: info@schardt.com

Montageanleitung - Assembly instructions - Instructions de montage - Montageaanwijzing

Kinderbett Spring 70 x 140 04 510

Inhalt - Contents - Contenu - Inhoud

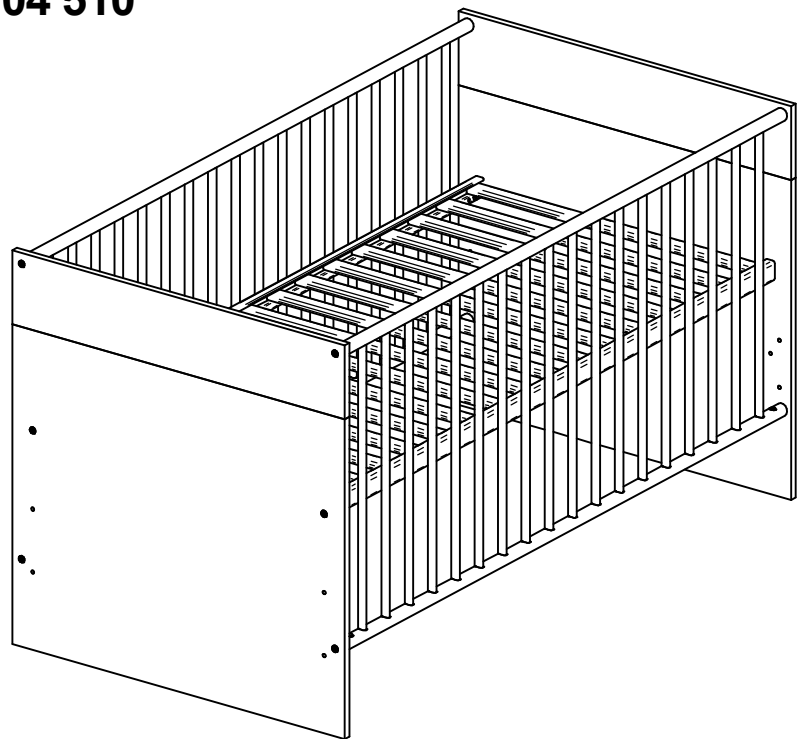

A M6 x 50 12 x	B 12/13 12 x
C 8 x 40 8 x	D SW4 1 x
E 2 x	

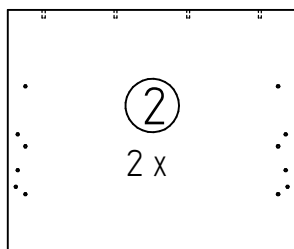
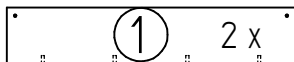

③

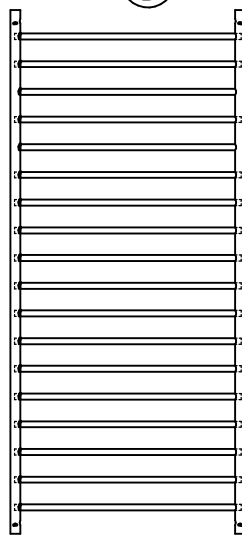

1 x Seitengitter

④

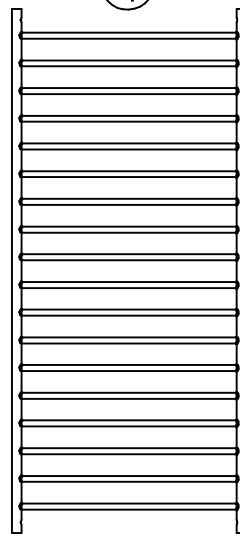

1 x Seitengitter mit
Schlupfstäben

⑤

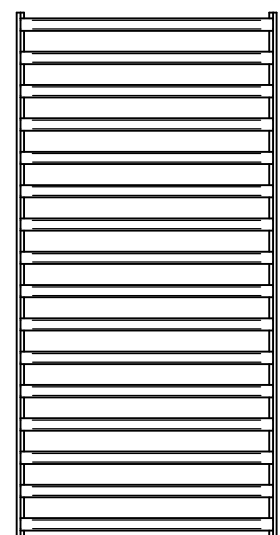

1 x Bettrost

Vor weiterer Montage der Beschläge den Leim 30 min abbinden lassen.
 Before further installation of the fittings the glue thicken for 30 minutes.
 Avant l'installation ultérieure des raccords, la colle épaissir pendant 30 minutes.
 Voor verdere montage van het beslag de lijm dik gedurende 30 minuten.
 Prima ulteriore installazione dei raccordi addensare la colla per 30 minuti.
 Antes de la instalación posterior de los accesorios de la cola espesar durante 30 minutos.
 Antes da instalação posterior dos acessórios a engrossar cola durante 30 minutos.
 Πριν από την περαιτέρω εγκατάσταση των εξαρτημάτων πυκνώσει η κόλλα για 30 λεπτά.

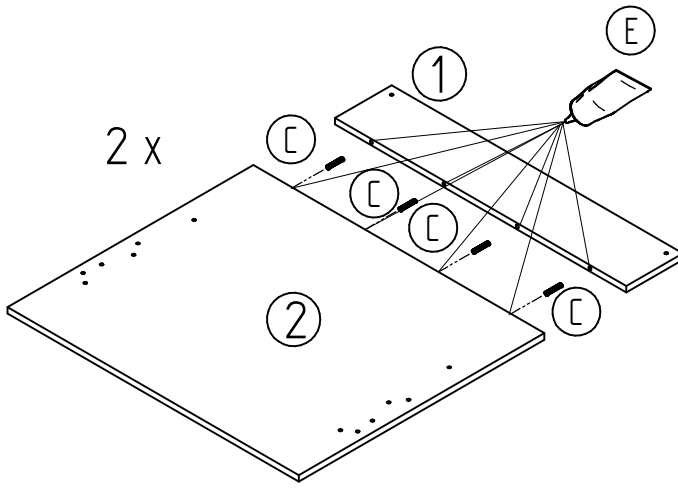

Gitter mit Schlupfstäben so einsetzen, dass die Federn der Schlupfstäbe oben sind.

Beim Herausnehmen der Schlupfstäbe sind immer alle Stäbe zu entfernen, um unzulässige Öffnungsmaße zu vermeiden.

