

Porto

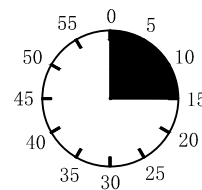

1

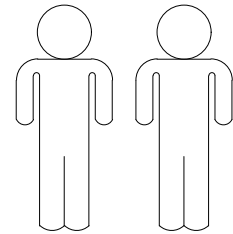
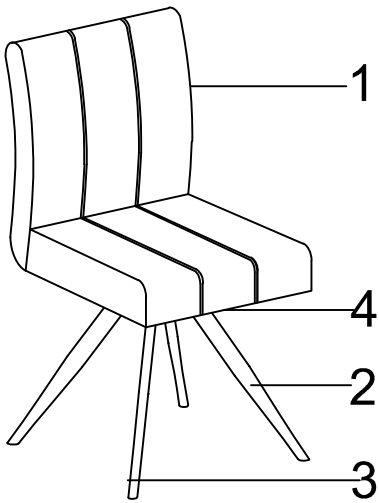
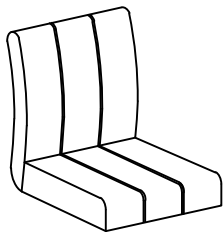

2

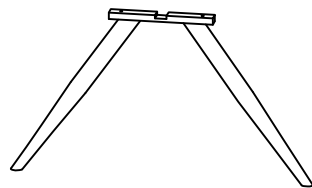

3

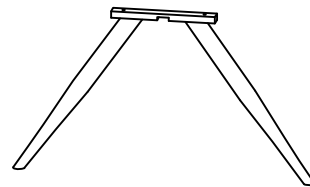

4



DT 170X170mm

1	1X
2	1X
3	1X
4	1X



1/1

A

M6*15



8X

B

M6*20



2X

C

M6*30

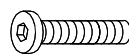

2X

D

Ø18*Ø6.5*1.5



12X

E

Ø20*Ø8*5



2X

F

T3*70*70



1X

G

4mm





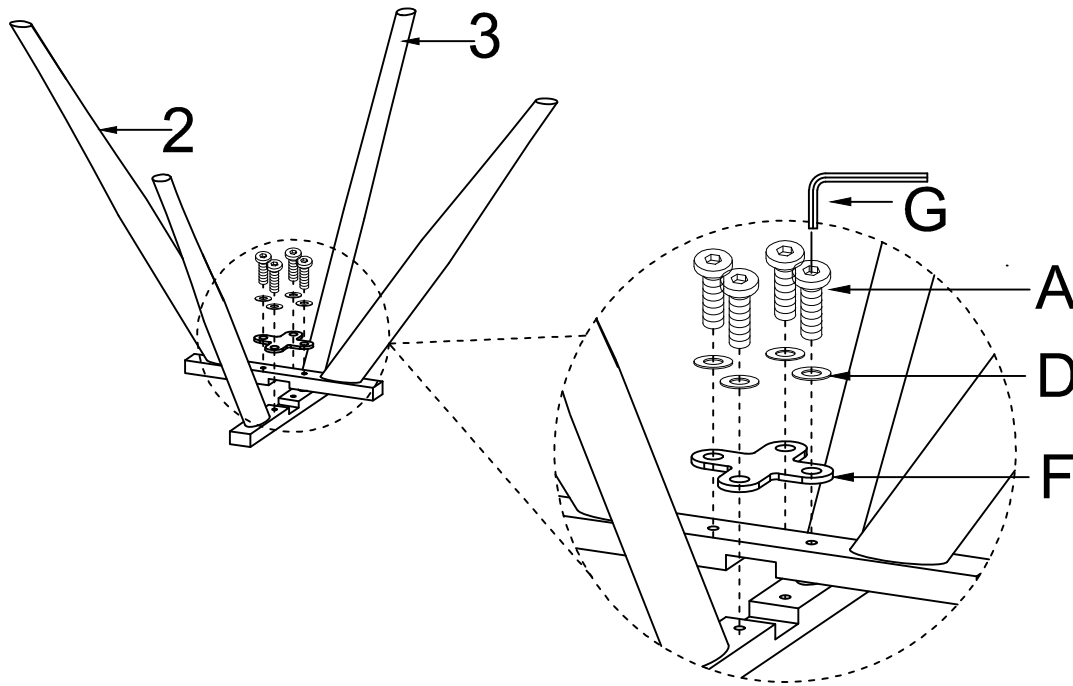

1X

I.



1.

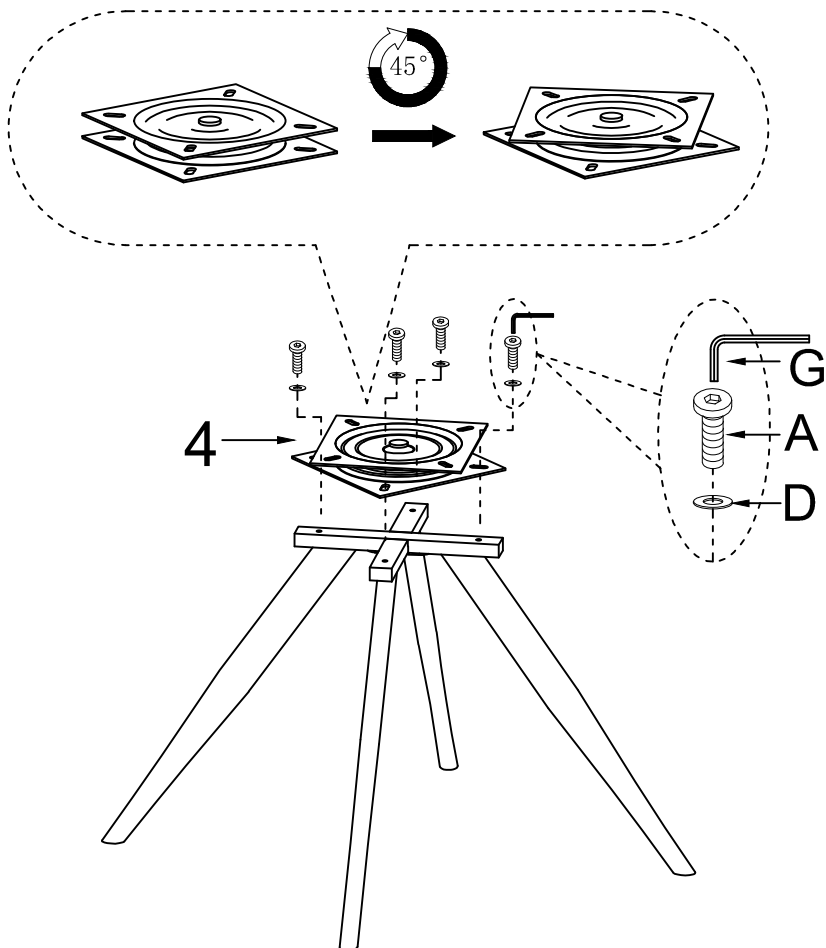

A	M6*15
	4X
D	Ø18*Ø6.5*1.5
	4X
F	T3*70*70
	1X
G	4mm
	1X
	

2.



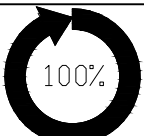



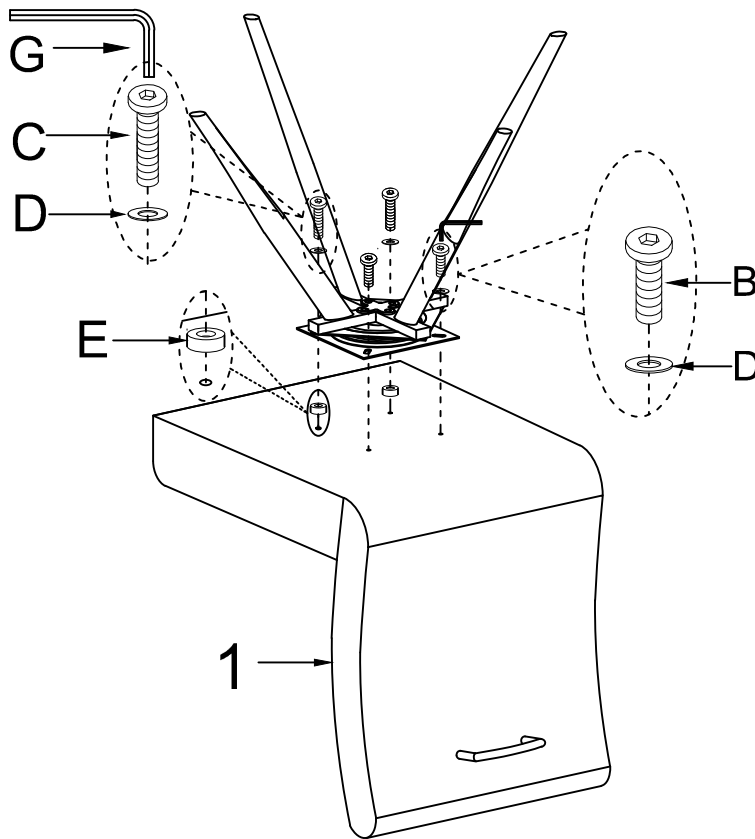

A	M6*15
	4X
D	Ø18*Ø6.5*1.5
	4X
G	4mm
	1X
	

II.

3.



B	M6*20
	2X
C	M6*30
	2X
D	Ø18Ø 6.5*1.5
	4X
E	Ø20*Ø8*5
	2X
G	4mm
	1X
	

4.

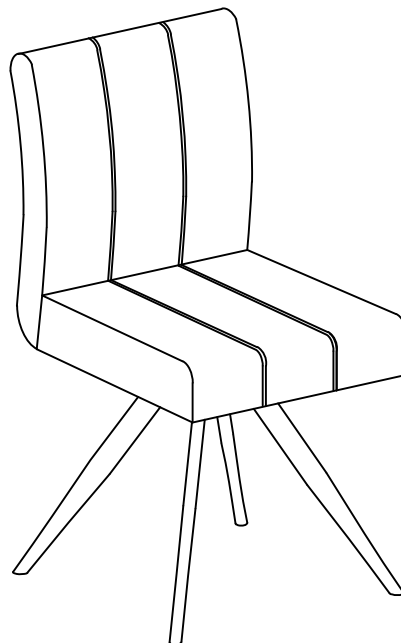

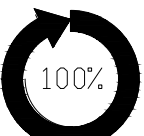
G	4mm
	1X
	



Séparez les éléments avant de trier