

Brooklyn II (2AL-MaxiRC)(MaxiRC-2AL) variabel



- | | |
|----------------------------------|--------------------------------|
| (DE) Montageanleitung | (FR) Notice de montage |
| (PL) Instrukcja montażu | (RO) Instrucțiuni de asamblare |
| (NL) Handleiding voor de montage | (SK) Montážny návod |
| (GB) Assembly instructions | (CZ) Montážní návod |
| (TR) Montaj talimatı | (HU) Szerelési útmutató |
| (RU) Инструкция по монтажу | (SLO) Navodila za montažo |
| (IT) Istruzioni di montaggio | |

Service - Servis - Dienstverlening - Servis - Serwis - Сервисная служба - Servizio - Service
 Serviciu - Služby - Szolgáltatás - Storitev

Da es sich hier um ein variables Modell handelt, muss vor Montage entschieden werden, welches Element rechts oder links stehen soll. Entsprechend müssen dann die Arm- bzw. Rückenlehnen angebracht werden. Hierzu den Reißverschluss an der Unterseite öffnen und anhand der vorhandenen Bohrungen in den Seitenwänden die Löcher im Stoff freilegen (Schere, Cuttermesser o.ä.).

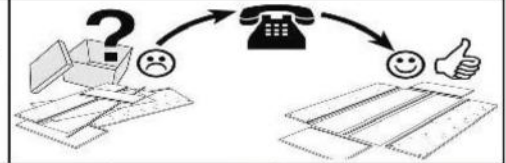

6x 60x60	2x 50x50	S1x9 M8x100	U1x9	S2x8 M6x20	B1x2	B2x2
X	Y	Z	C	D	E	
2AL	MaxiRC	MaxiRC	5x H-135	10x 8x50	3x	1x 13

2AL-MaxiRC
L=2-4





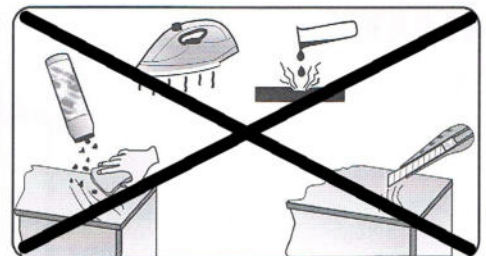
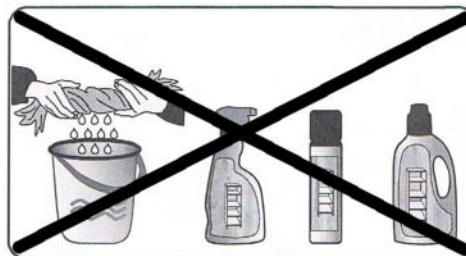
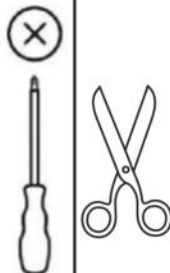
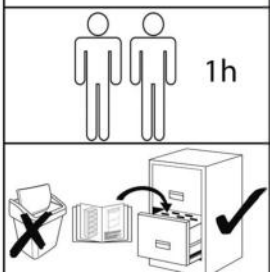

MaxiRC-2AL
R=5-7

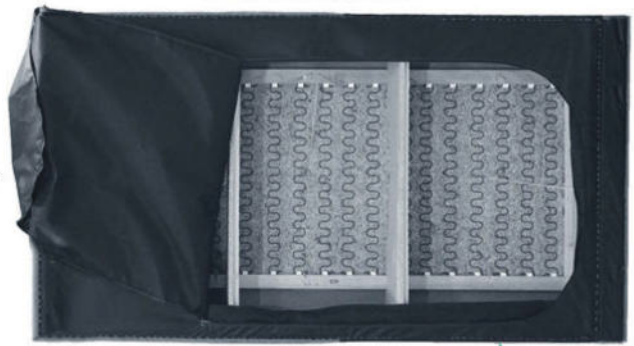
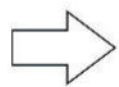
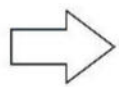
09-04-2026



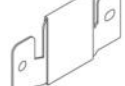

					X	
S1x3	M8x100 U1x3	S2x4 M6x20	B2x2	1x	13	2AL



1





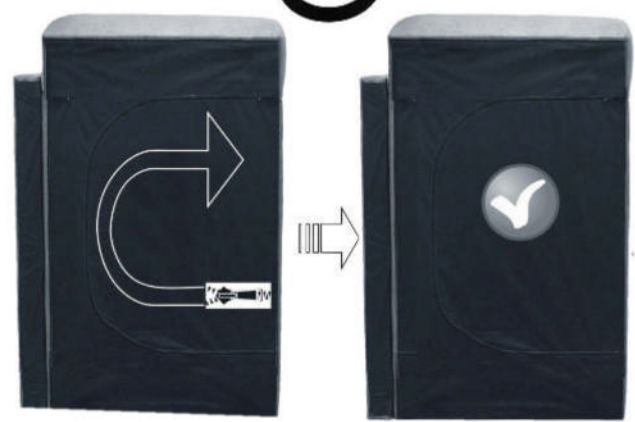

2

3

U1x3 S1x3 S2x4 B2x2

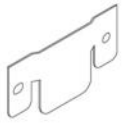
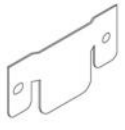
09-04-2026



 S1x6	 U1x6	 S2x4	 M6x20	 B1x2	 1x	 13	 MaxiRC
--	--	--	---	--	--	---	---



MaxiRC

④

⑤

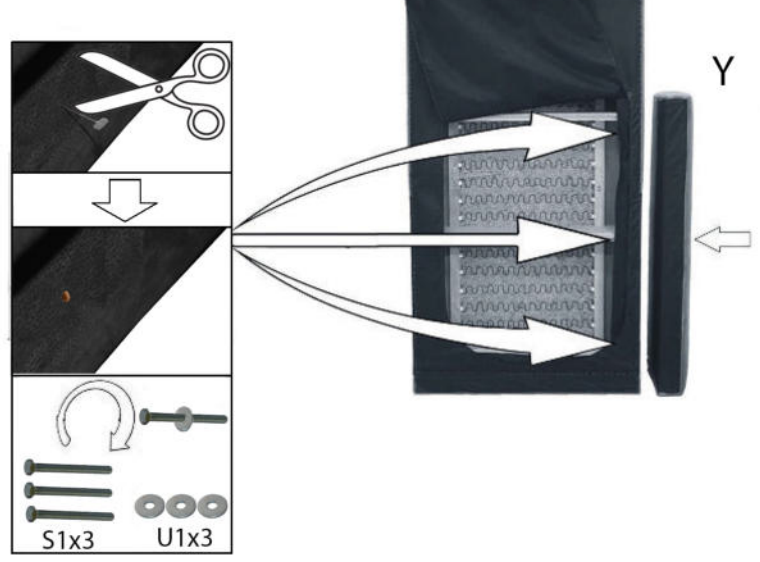
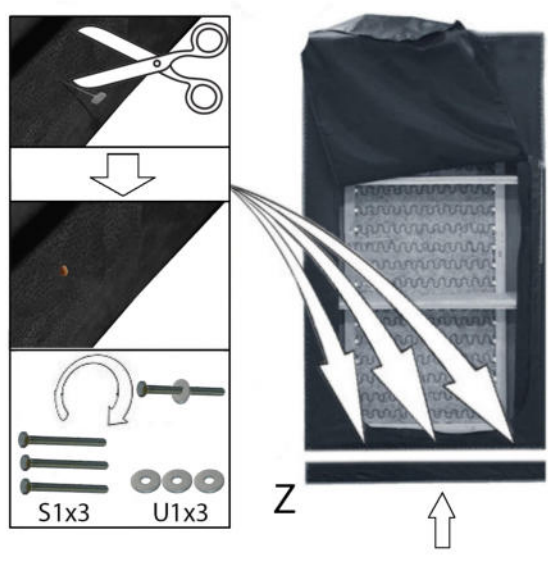



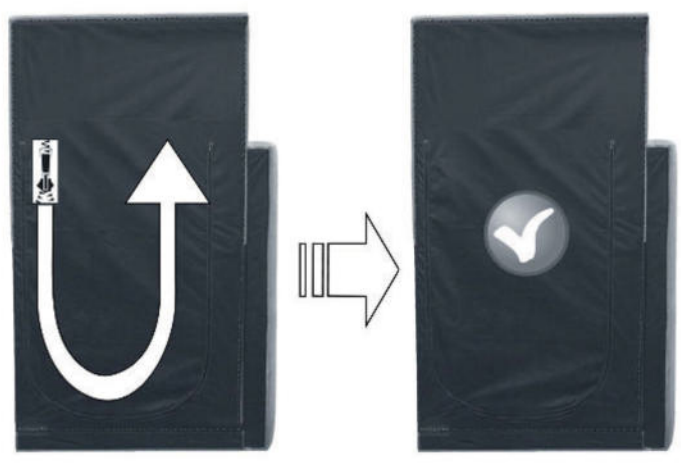
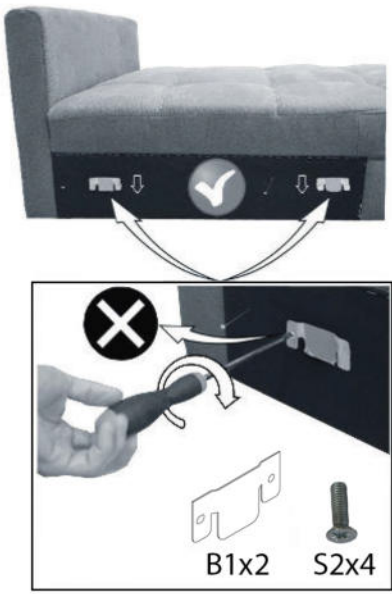

⑥

⑦

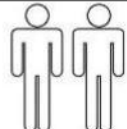

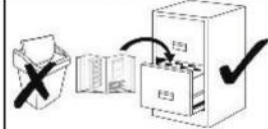
09-04-2026

 1h		
		

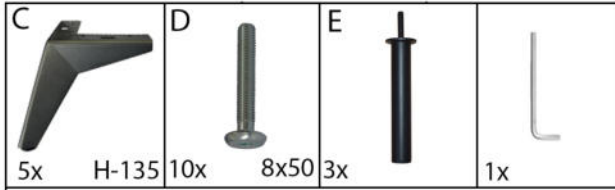

8

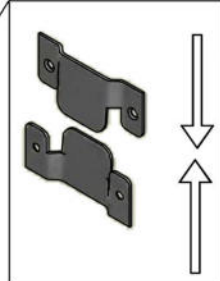
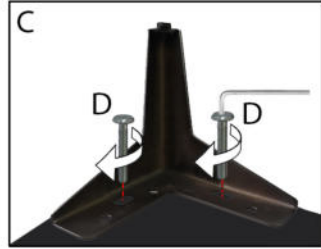



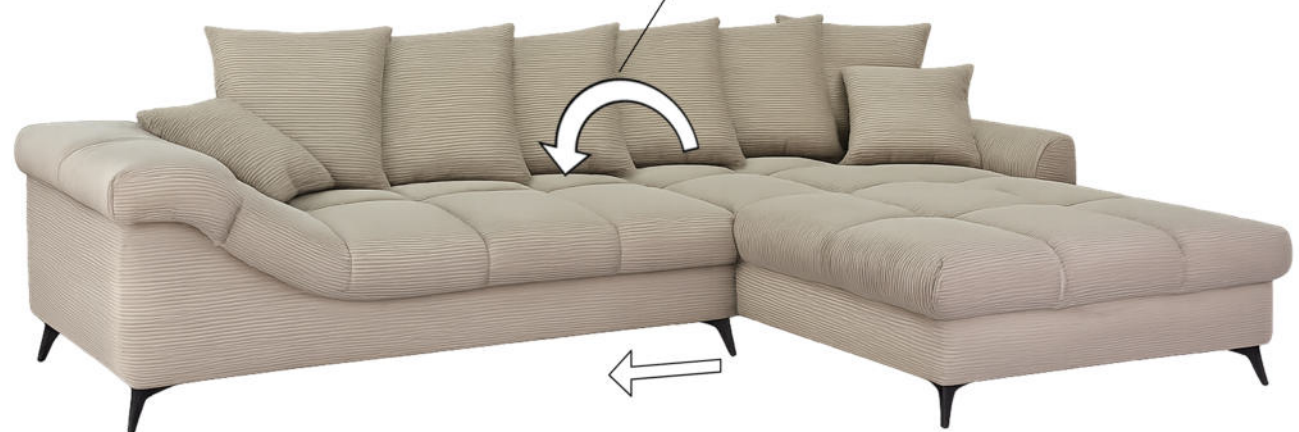

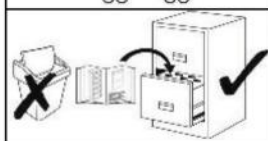
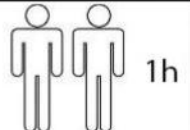

9



09-04-2026

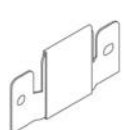

 S1x3	 U1x3	 S2x4	 M6x20	 B2x2	 2AL	 1x	13
--	--	--	---	--	---	---	----



2AL

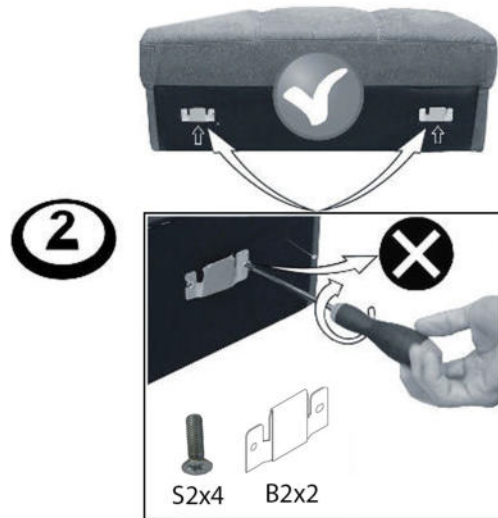
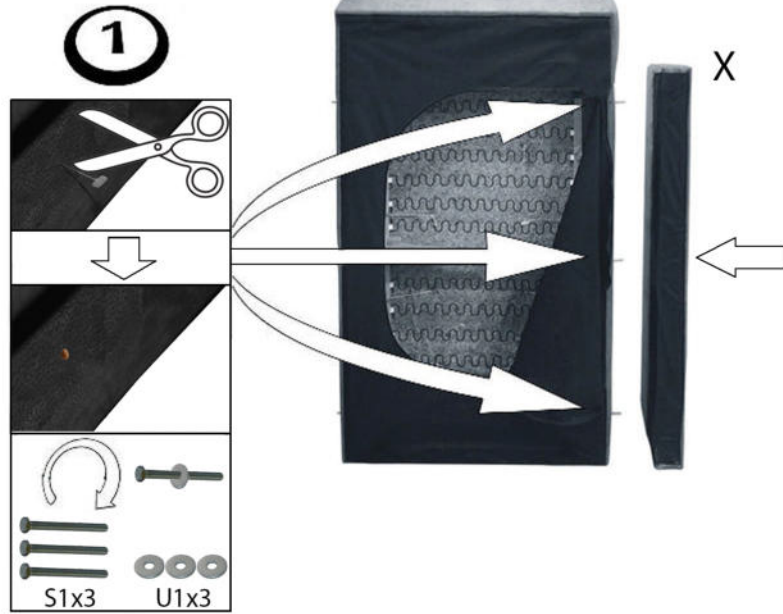

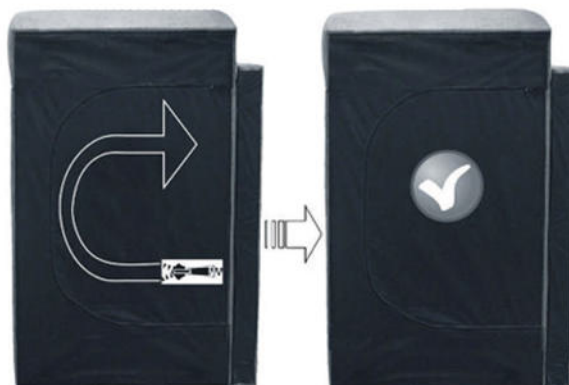

3

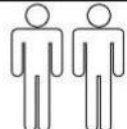

09-04-2026

 1h





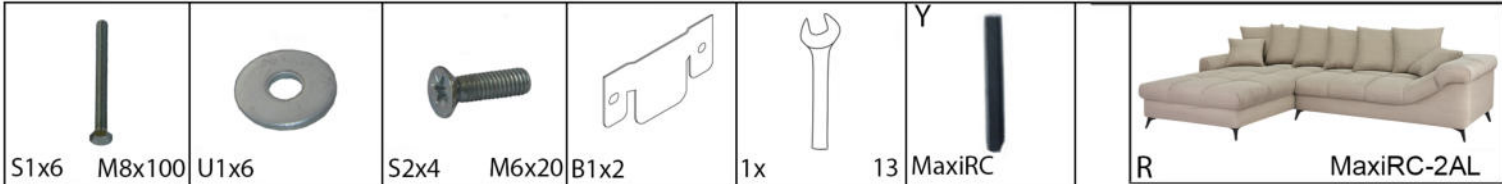

MaxiRC

4

5

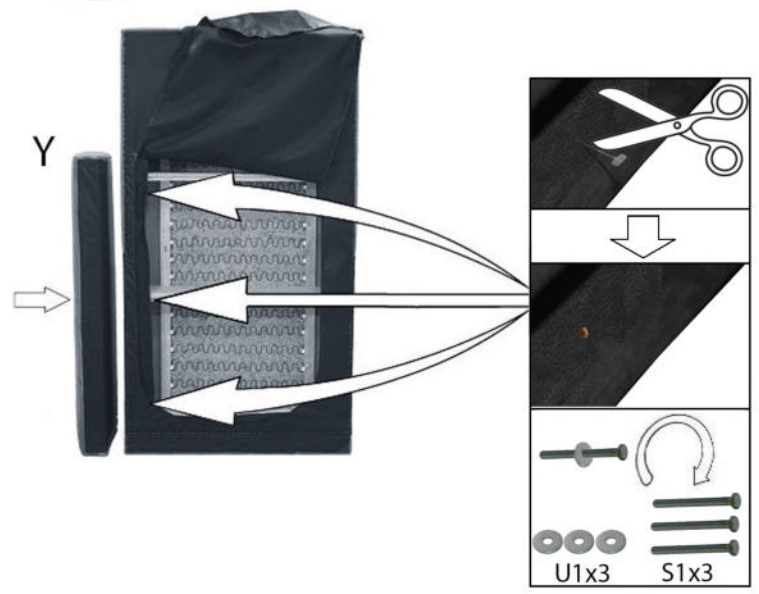
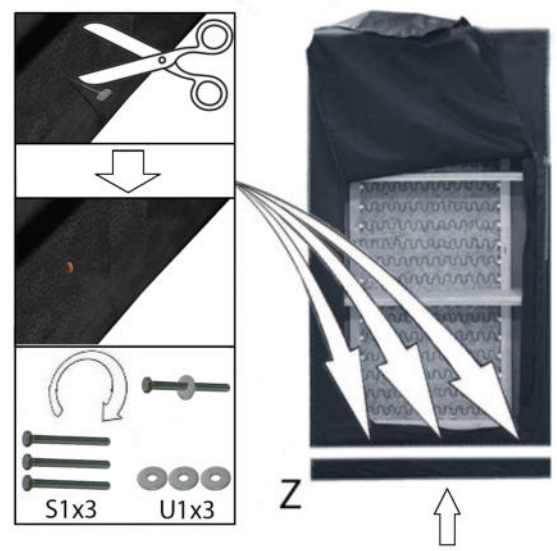

6

7

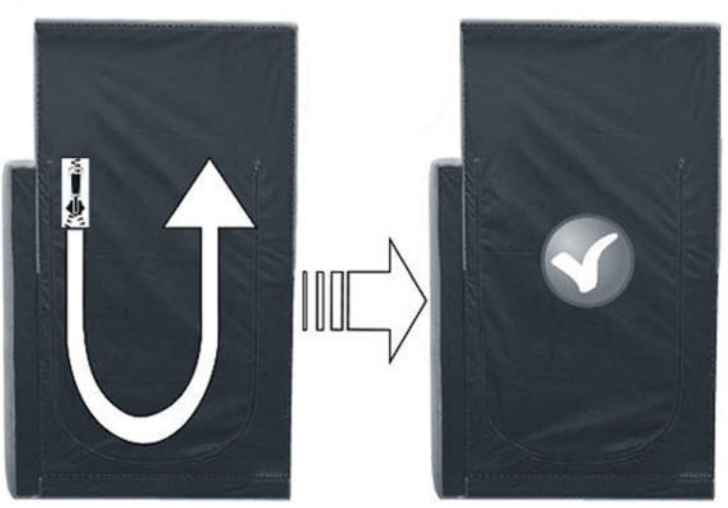
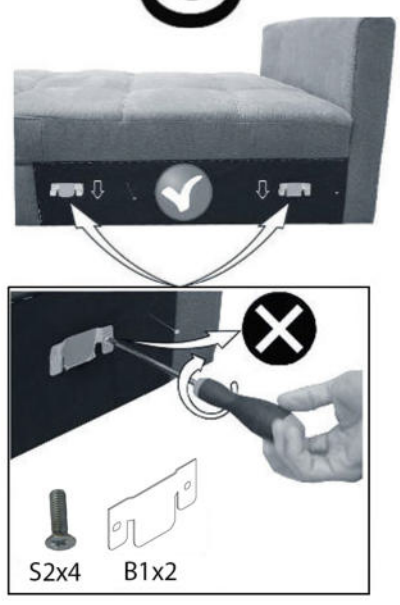

09-04-2026

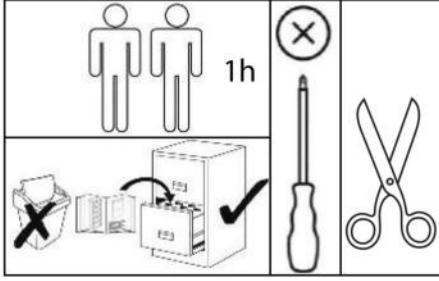

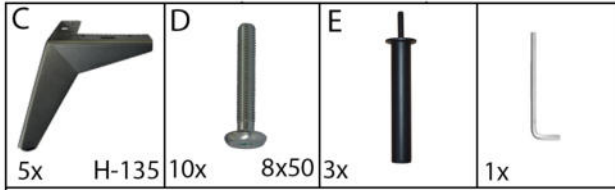

8

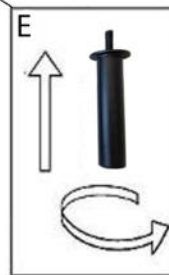
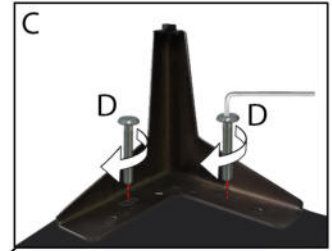
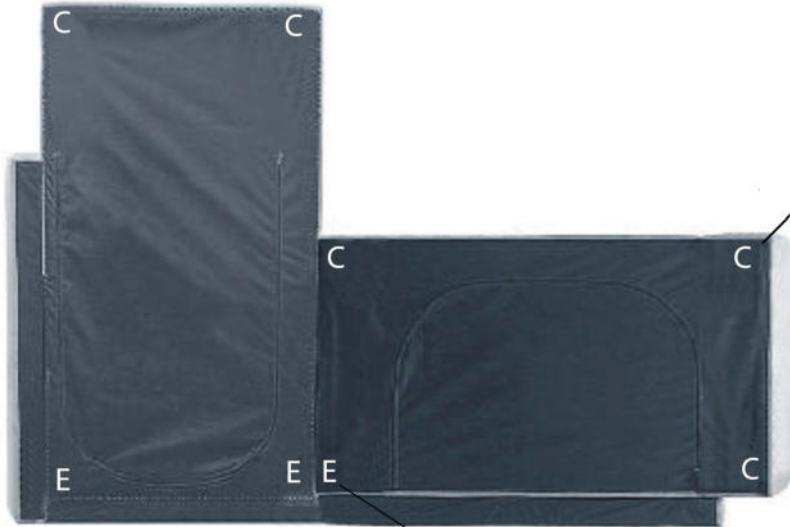

9

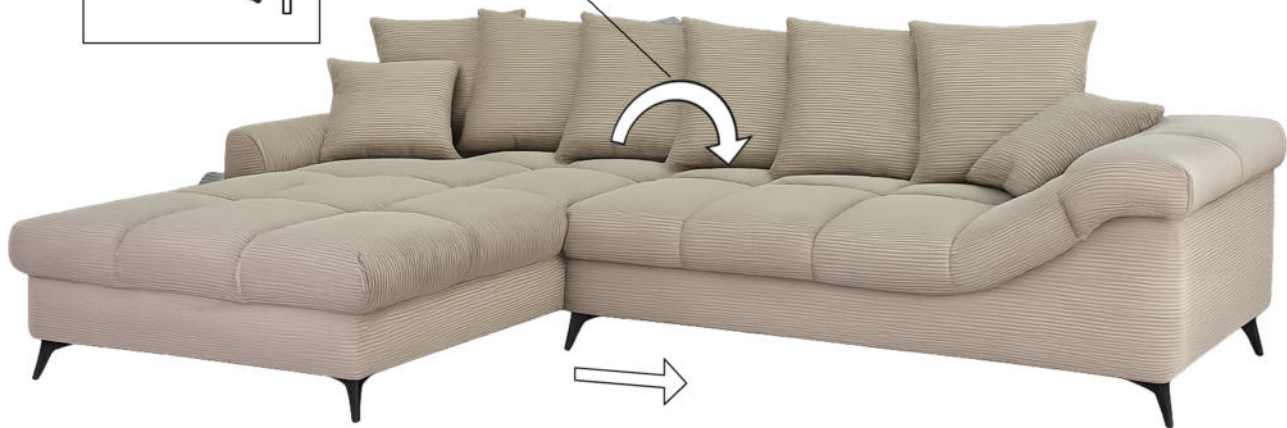
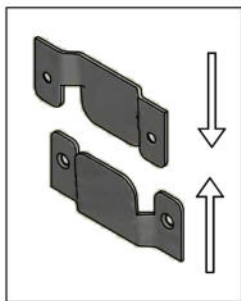

09-04-2026

