

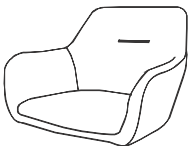

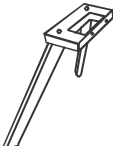





ASSEMBLY INSTRUCTION



A X1	B X1	C X1	D X1	E X2
				 M8*16
F X8	G X4	H X4	I X2	J X1
 M6*16*1.5	 M6*16	 M6*12	 M8*16*1.5	 M5

2-1

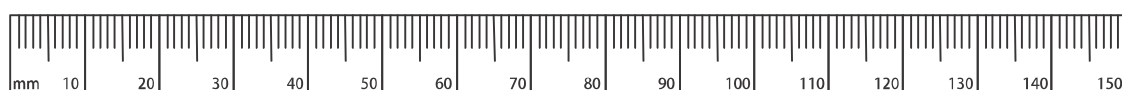

1

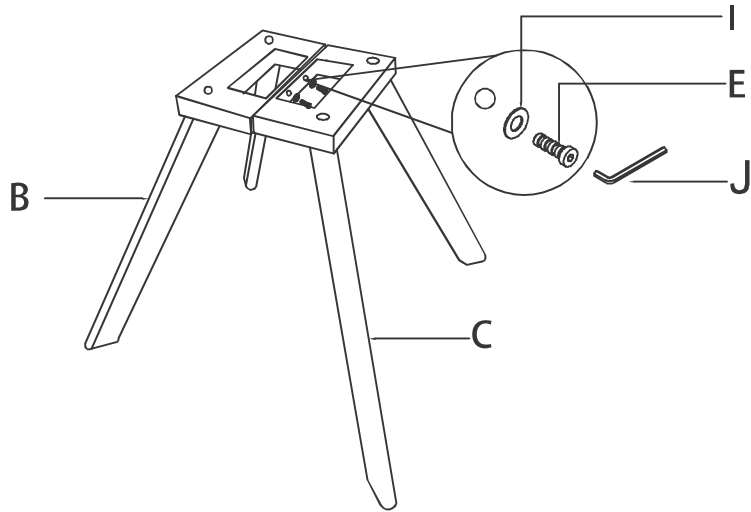

B X1	C X1	E X2
		M8*16
I X2	J X1	
M8*16*1.5	M5	

2

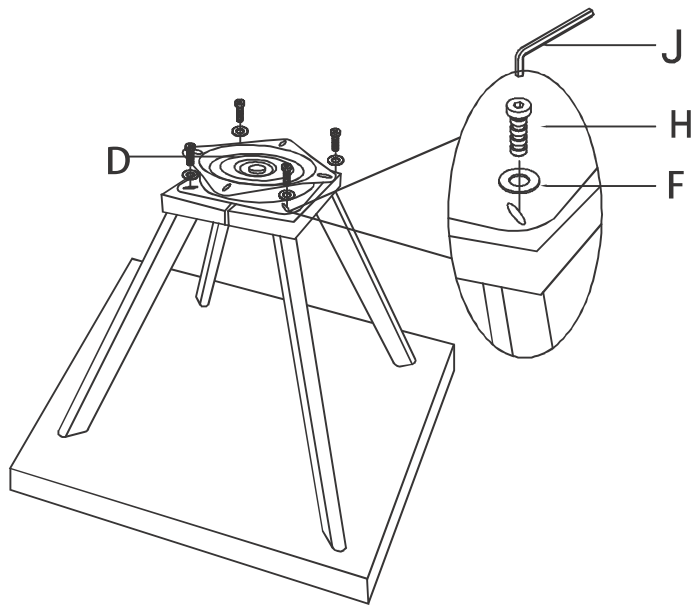

D X1	H X4
	M6*12
F X8	J X1
M6*16*1.5	M5

3

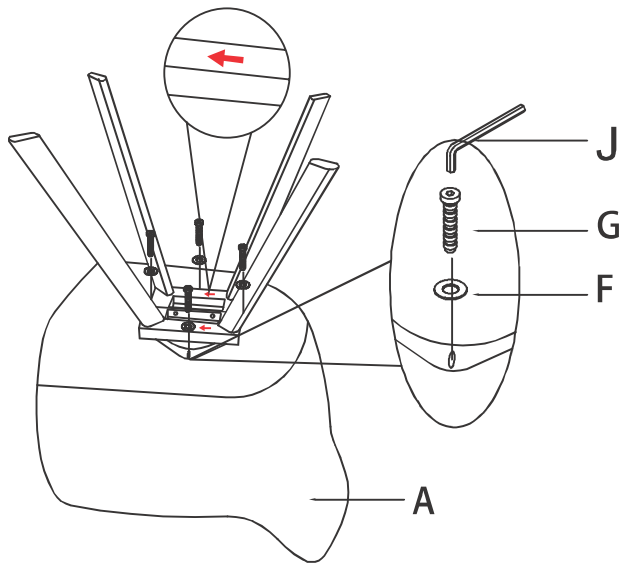

A X1	F X8
	M6*16*1.5
G X4	J X1
M6*16	M5

2-2

