

980814

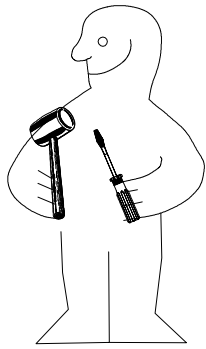

1.



2.

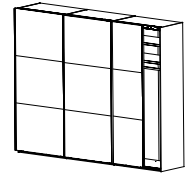
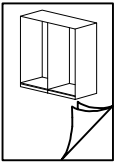
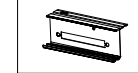
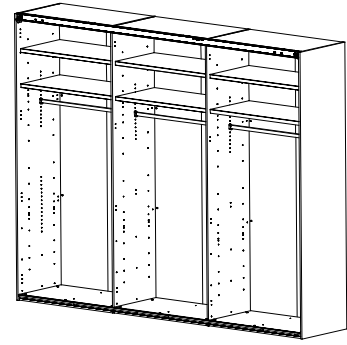
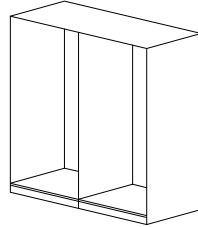

SHSP 300 3trg

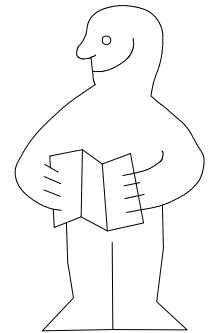
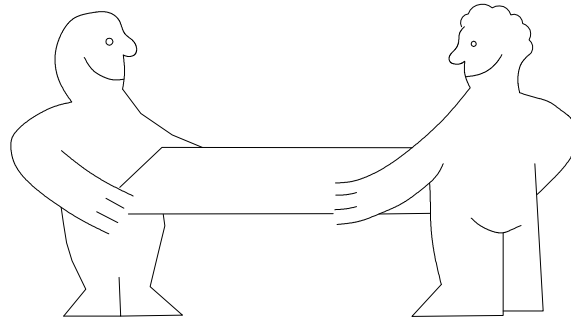
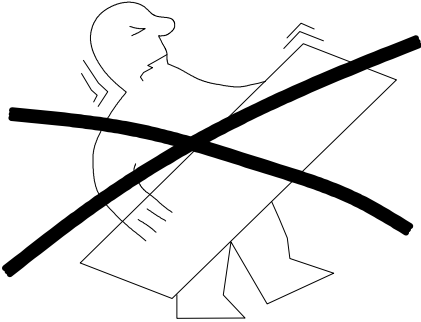

1-2-3-4... ○

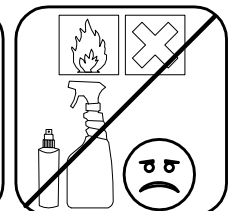
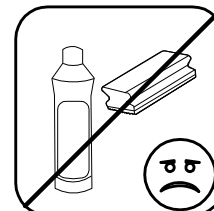
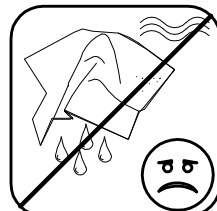
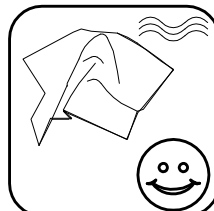
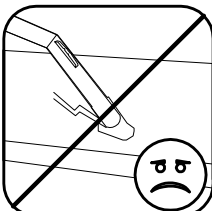
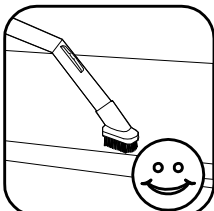
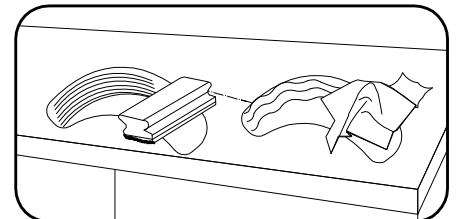
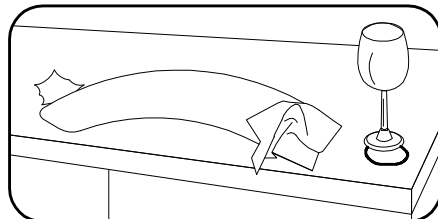
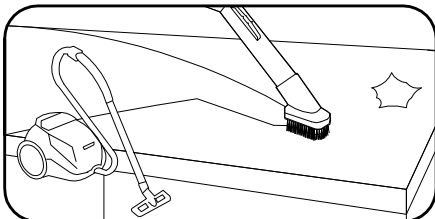
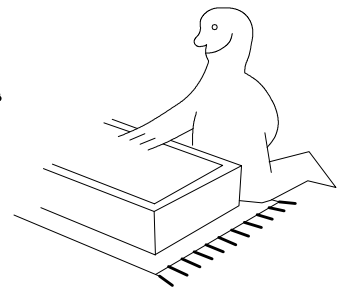
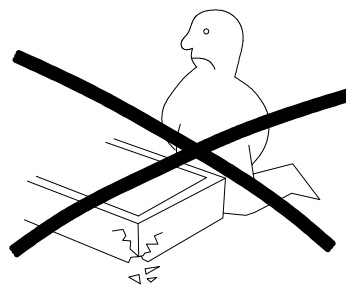
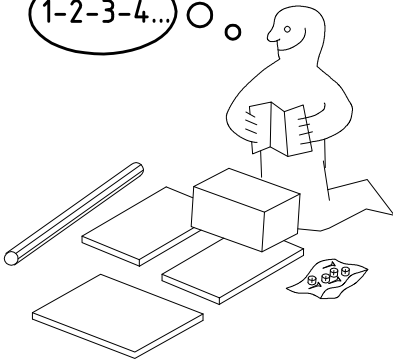





980814

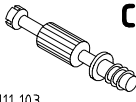

16.12.16 / 01.12.17



12 17

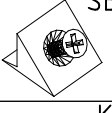

1 / 11

 111 149	A1	24x
 111 103	C	8x
	F3	8x

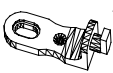
 111 300	S0	15x
 111 xxx ø12	V12	15x
 121 370 3,5 x 15 mm	G1	48x



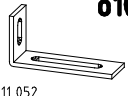

 117 002	K2	6x
	SBV	24x
 100cm 112 400	K10	3x

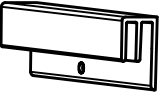

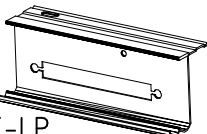
 111 611	J2	15x
 6,3 x 10,5 mm 112 055	T1	42x
 111 607	L8	24x

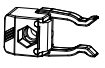
 111 052	o10	1x
 4 X 13mm 121 122	SP13	4x

1x 
FPK
14.53/19.40/24.30/29.20/34.08

1x 
SWT-LP
14.53/19.40/24.30/29.20 3-trg
/34.10 SY

 121 xxx	SWT-ST	2x
 M4 x 13 mm 121 xxx	SWT-SM5 GH13	2x
 M4 x 10 mm 121 xxx	G43	4x
 3,5 x 35 mm 121 375	G14	4x

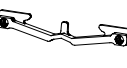
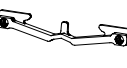
 121 004	SWH-SKL	1x
 3,5 x 22 mm 121 004	SWH-SKR G24	1x
	SW-STM	7x
	SW-STM	1x

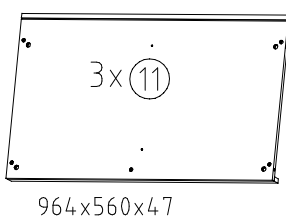
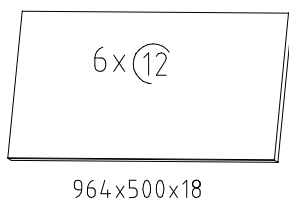
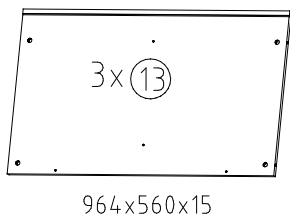
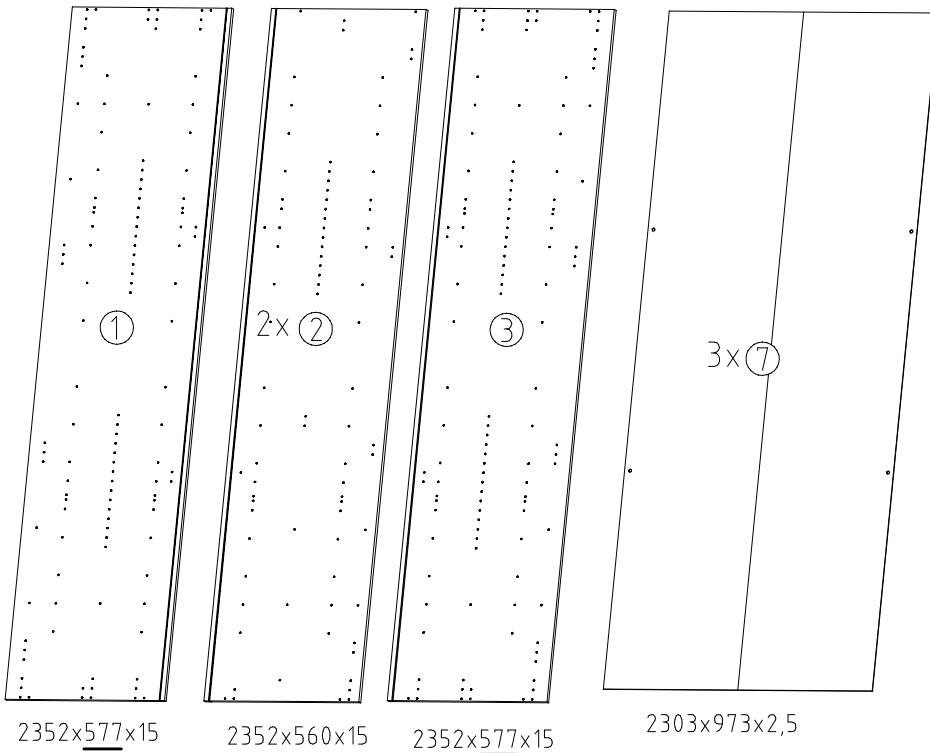
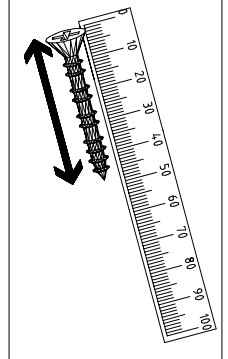
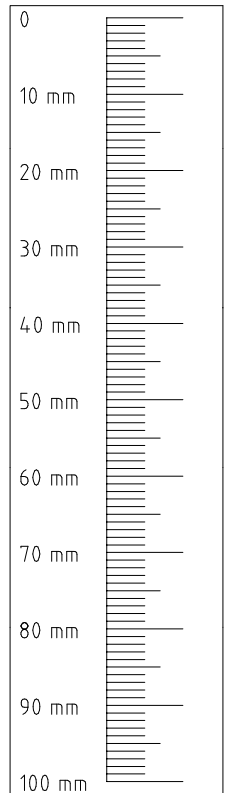
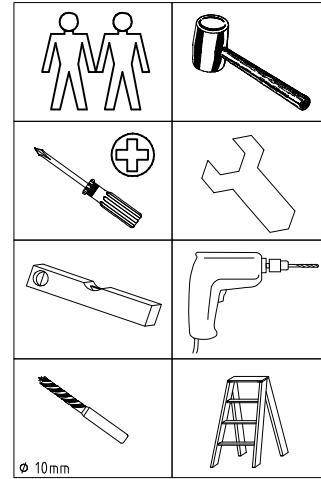

1

3,5 x 15 mm

G1

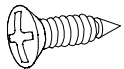

121 370

S0

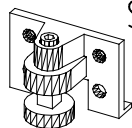

111 300

A1



111 149

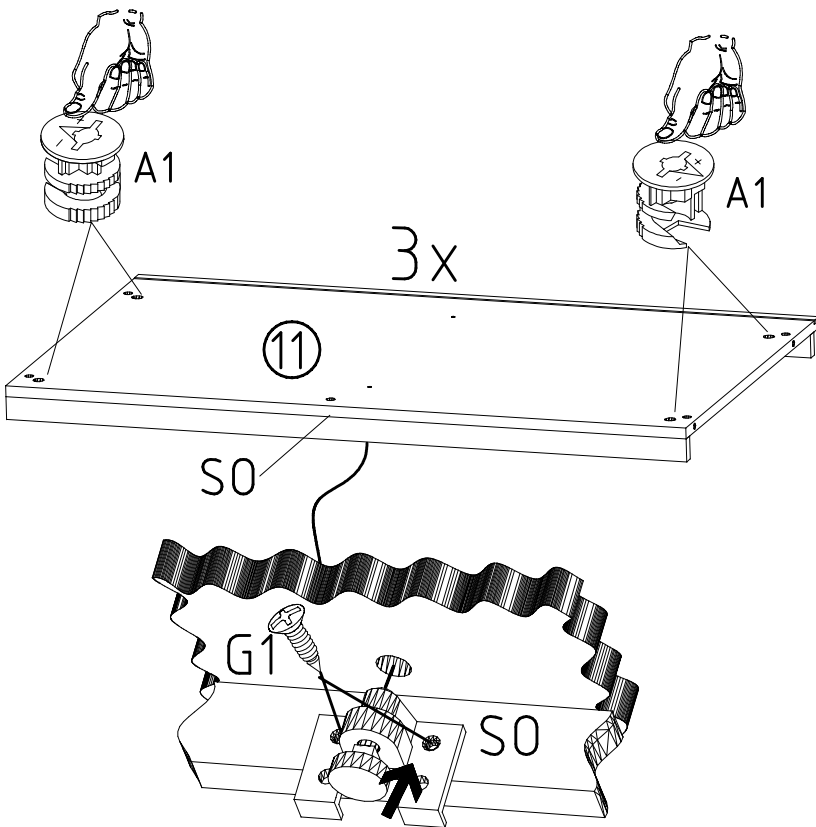

2

A1

111 149

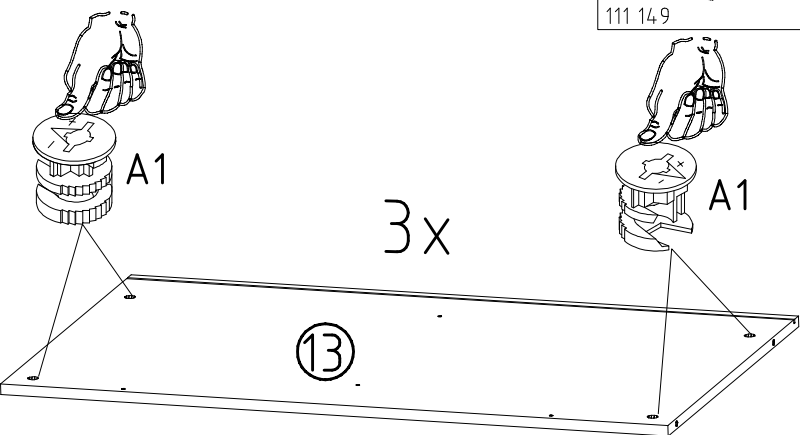

3

F3

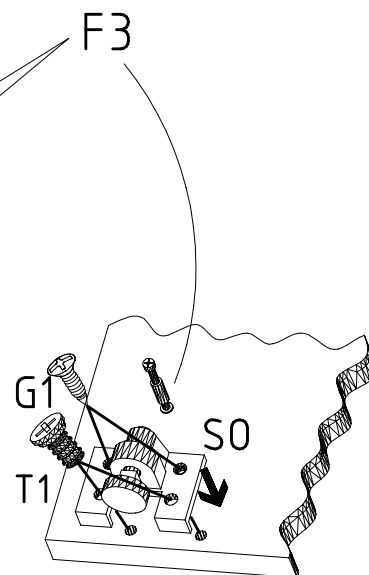
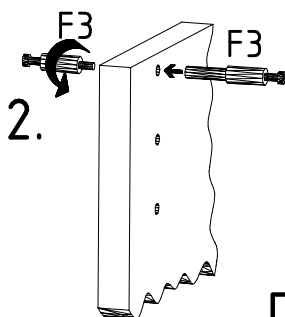
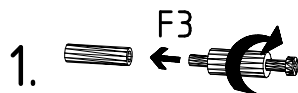
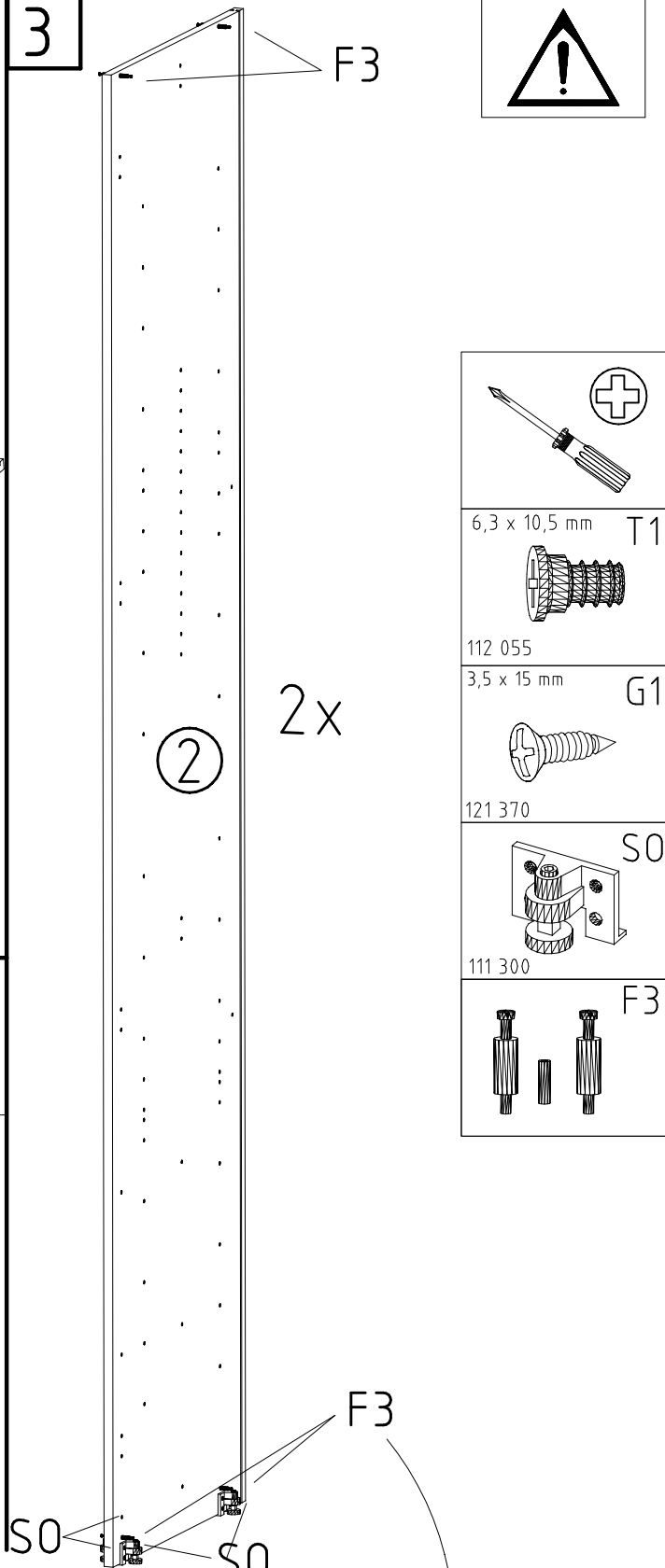
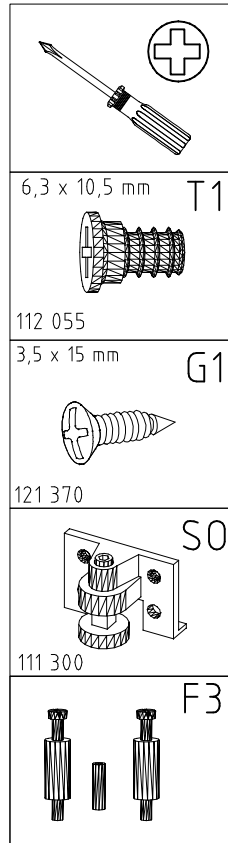

4

SWH-SKL

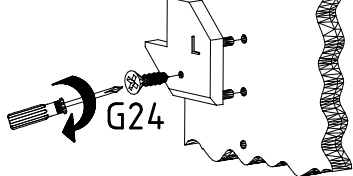

SWH-SKR

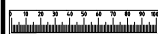
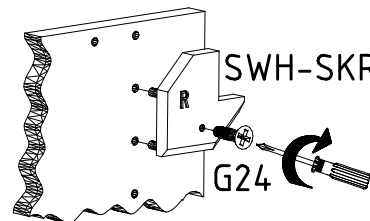

577

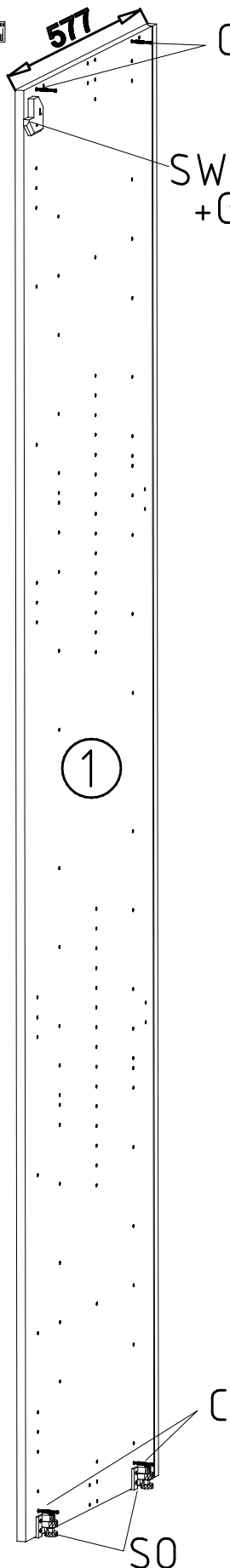

SWH-SKL + G24

1

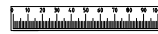
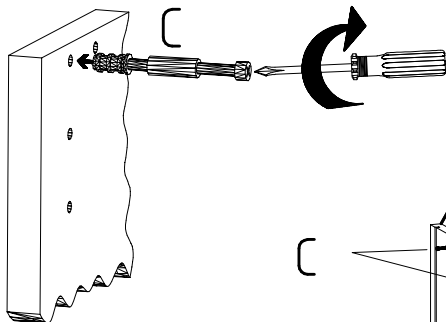

577

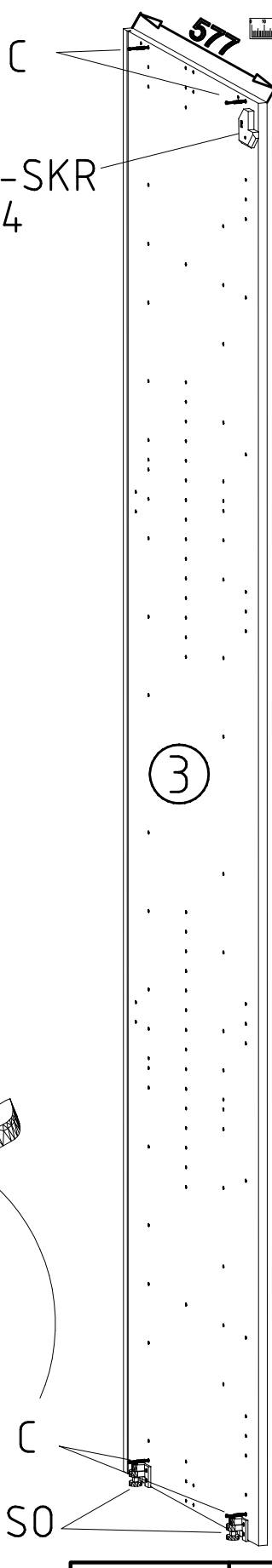

SWH-SKR + G24

3

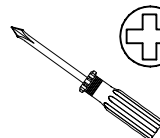
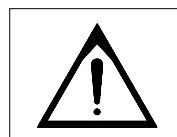

SWH-SKL

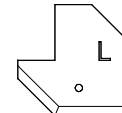

SWH-SKR

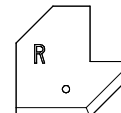

3,5 x 22 mm

G24

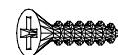

121 004

6,3 x 10,5 mm

T1

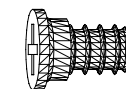

112 055

3,5 x 15 mm

G1

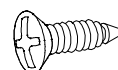

121 370

C

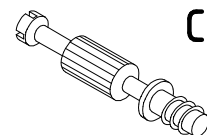

111 103

SO

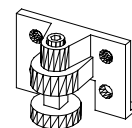

111 300

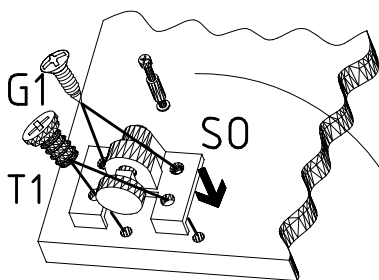

5

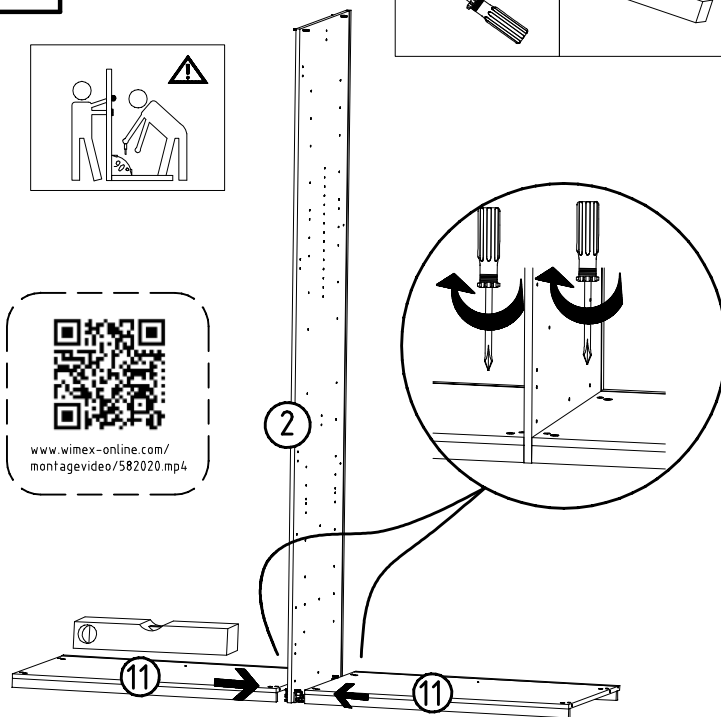
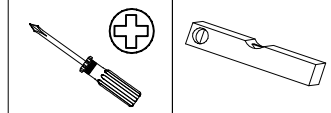

6

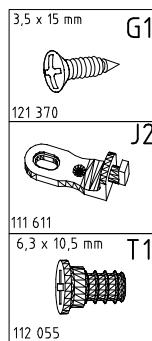
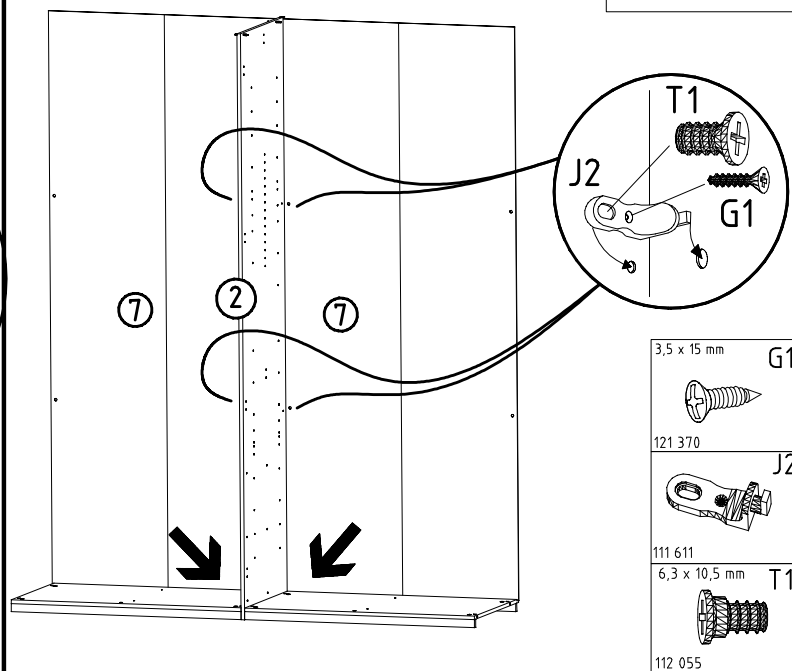
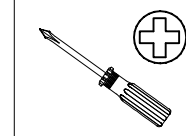

7

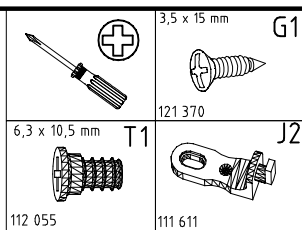

8

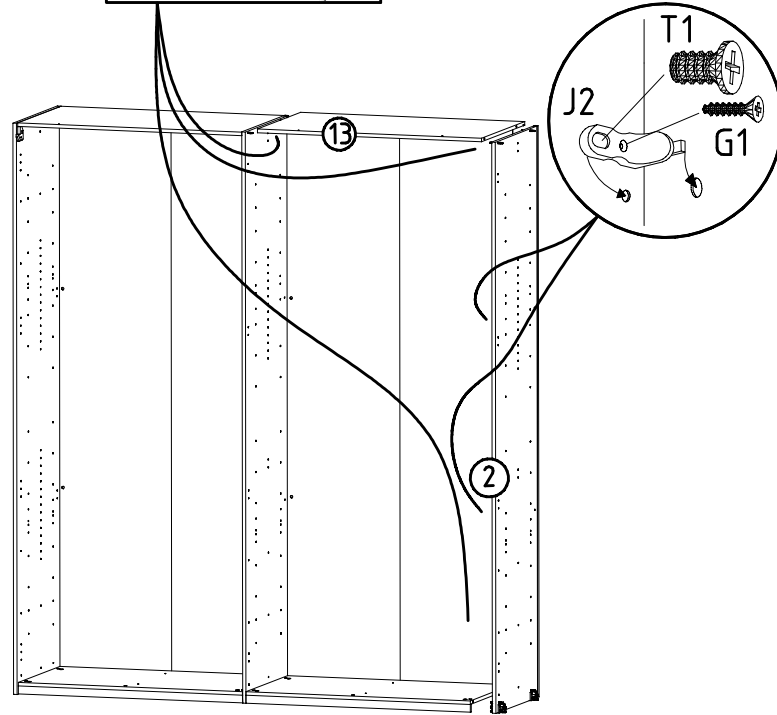
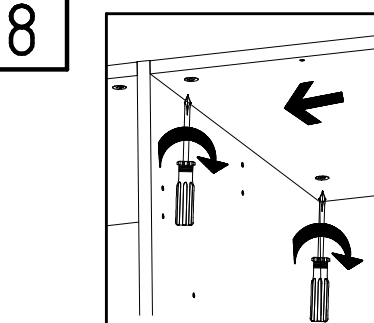
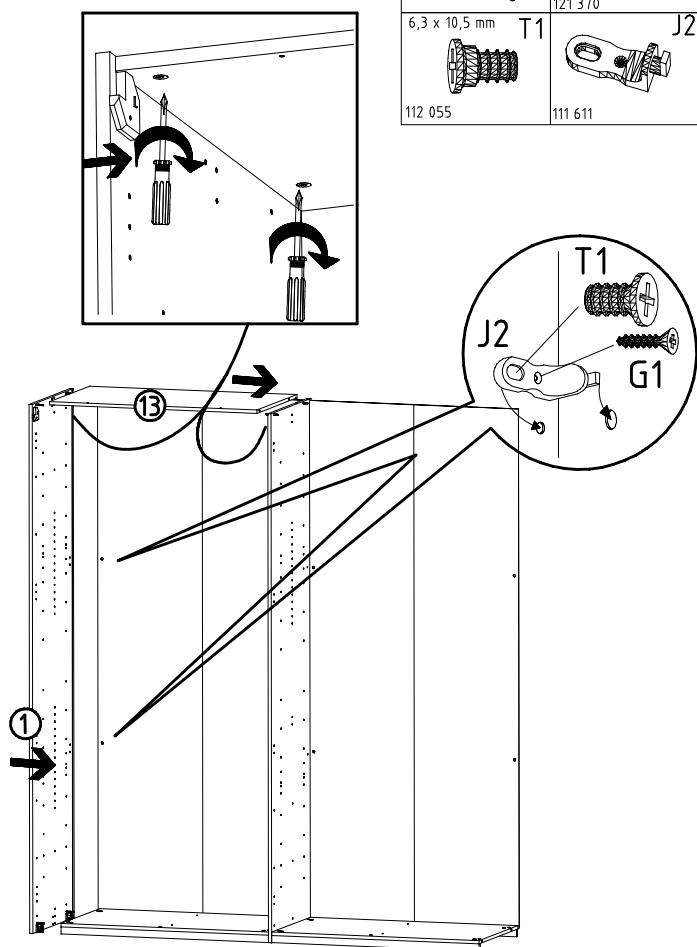
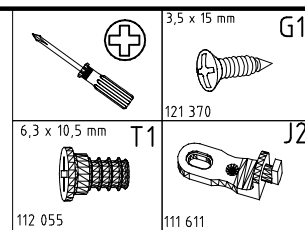

9

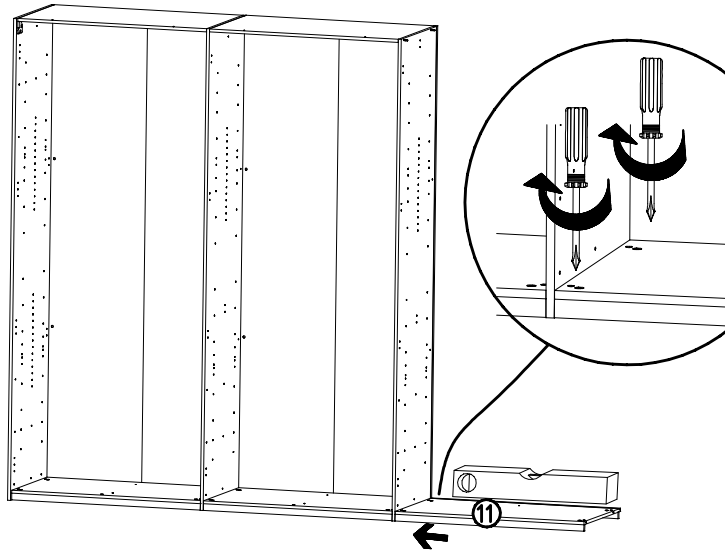
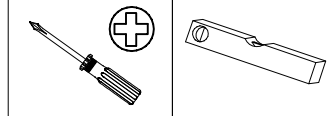
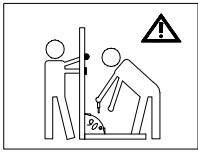

10

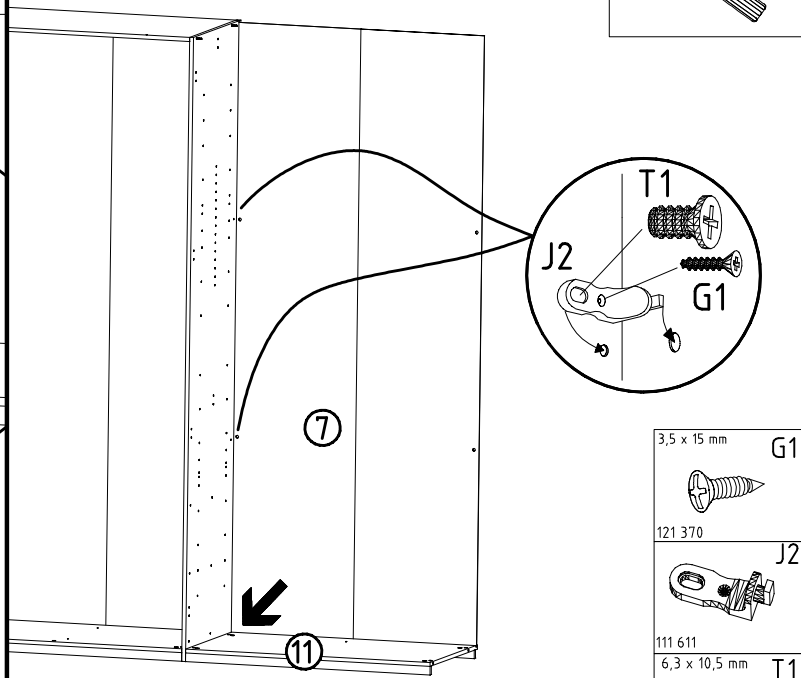
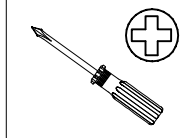

- 3,5 x 15 mm G1
- 121 370
- 111 611
- 6,3 x 10,5 mm T1
- 112 055

11

- 3,5 x 15 mm G1
- 121 370
- 111 611
- 6,3 x 10,5 mm T1
- 112 055

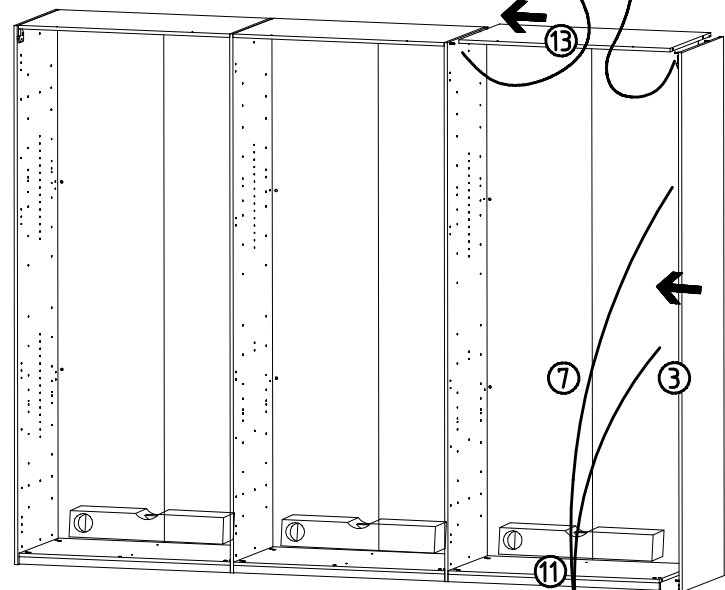
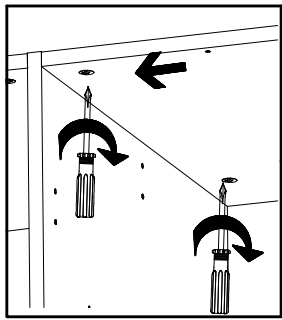

12

- L8
- 111 607
- K2
- 117 002
- 3,5 x 15 mm G1
- 121 370
- 100cm
- 112 400
- K10

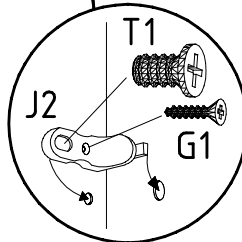
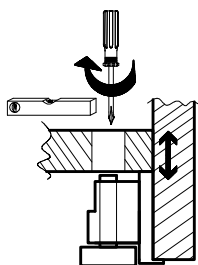
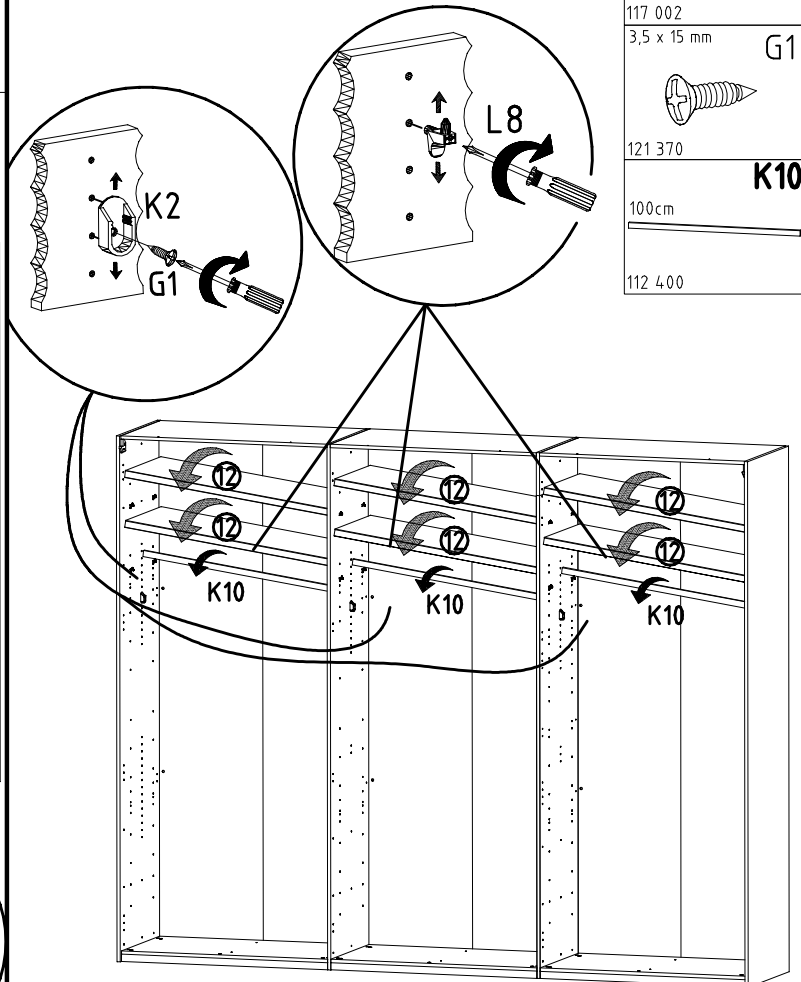

980814

16.12.16 / 01.12.17

12 17

6 / 11

13

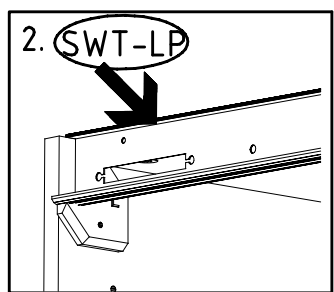
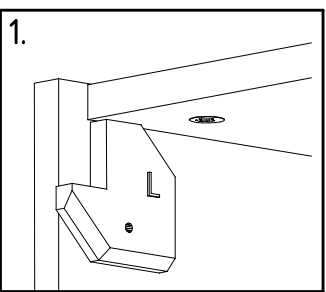

M4 x 13 mm GH13 121 xxx	3,5 x 35 mm G14 121 375	SWT-ST 	SWT-SM5
M4 x 10 mm G43 121 xxx	SW-STM 		

SWT-LP
1453/1940/2430/2920 3trg
/3410 SY

14

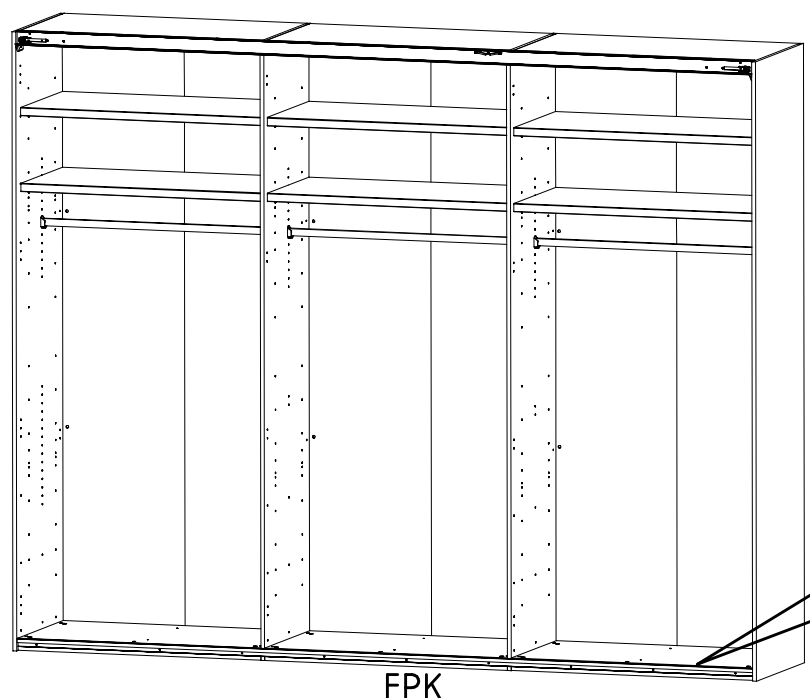

FPK
1453/1940/2430/2920/3408

3,5 x 22 mm G24 121 004

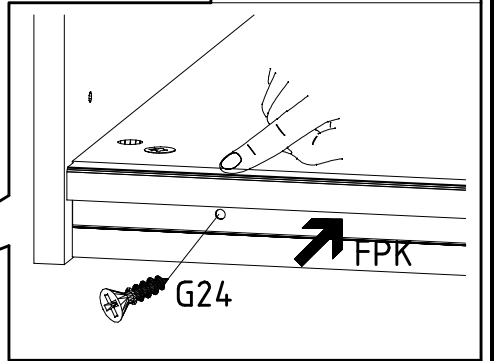

15

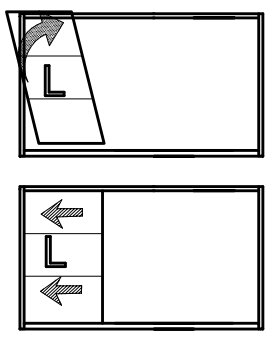

16

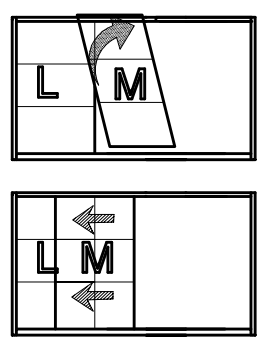

17

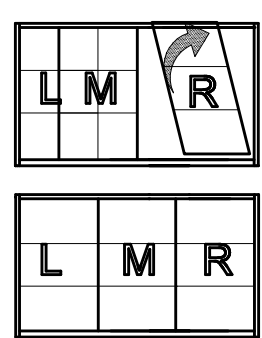

15 + 17

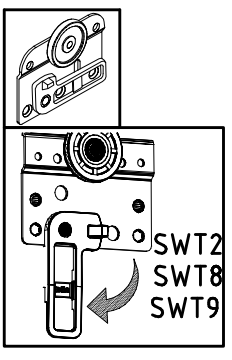
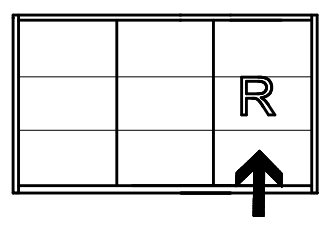
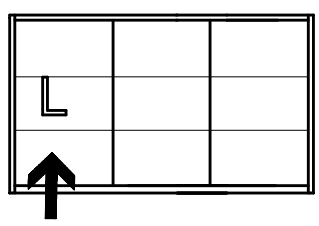

I.

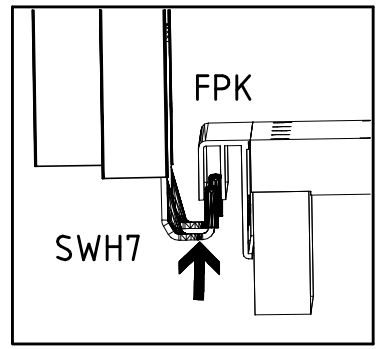

II.

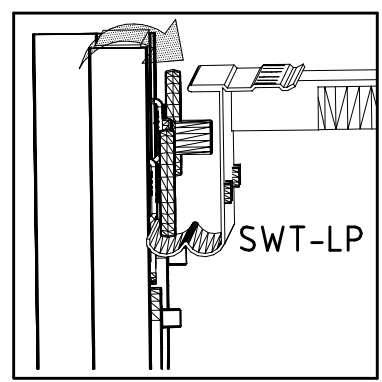

III.

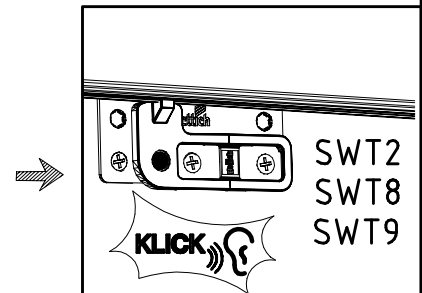
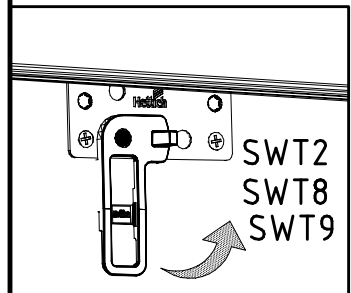

16

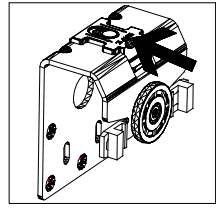
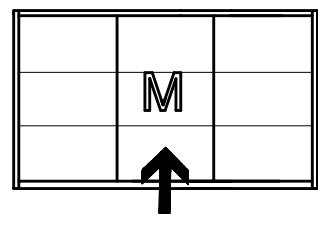

I.

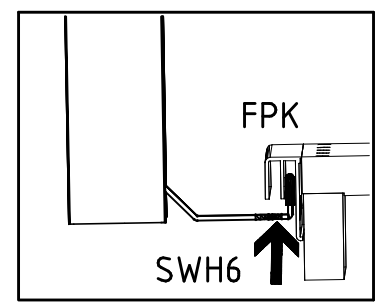

II.

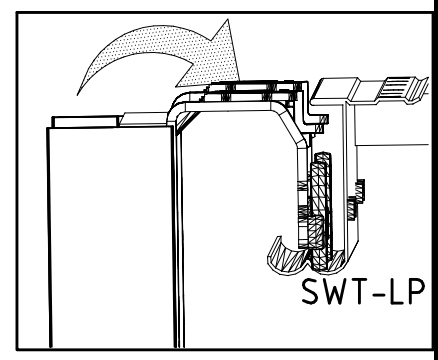

III.

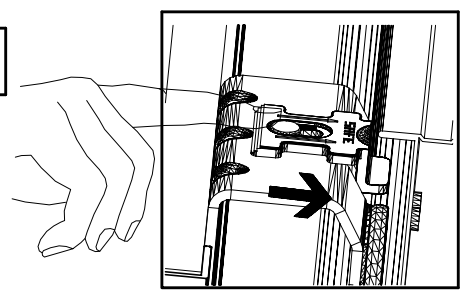

18

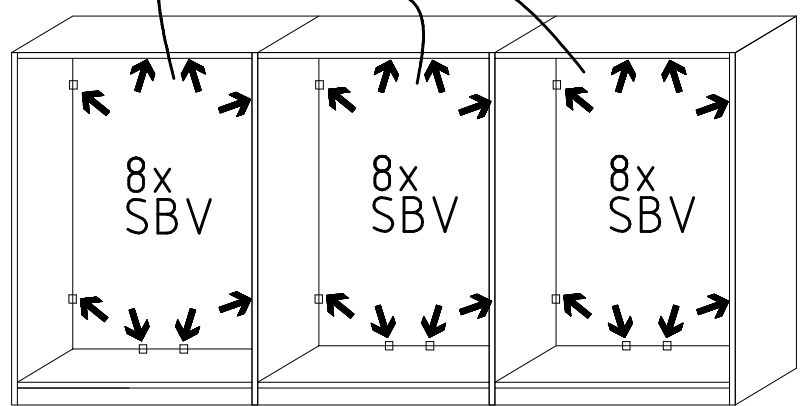
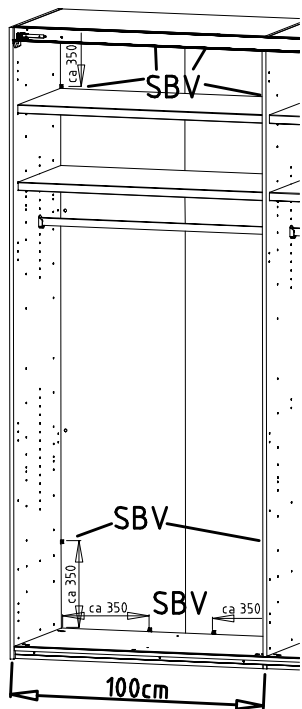
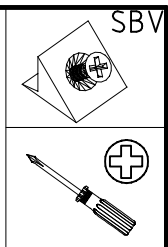
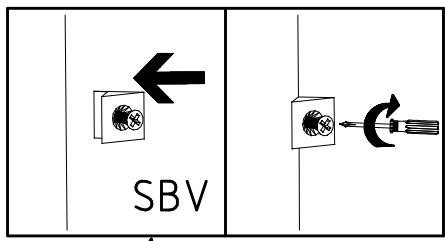

19

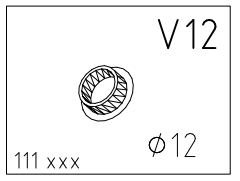
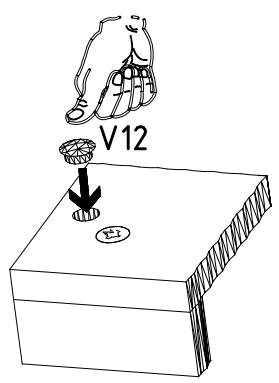
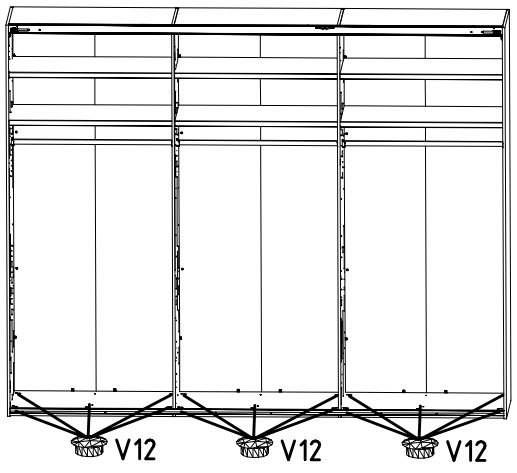

20

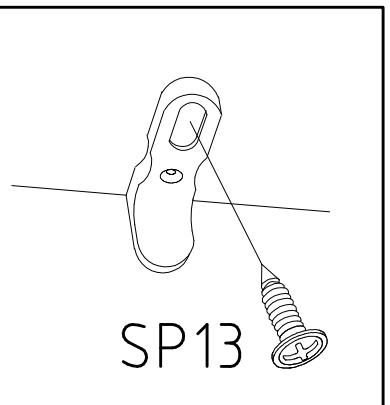
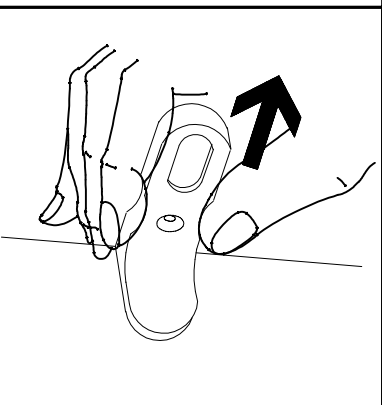
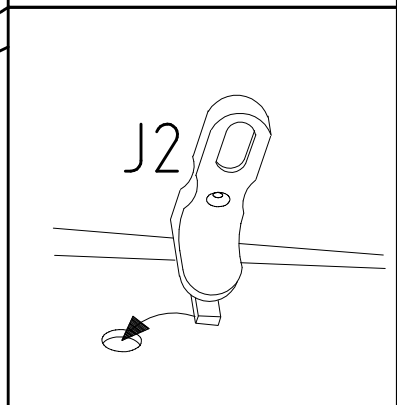
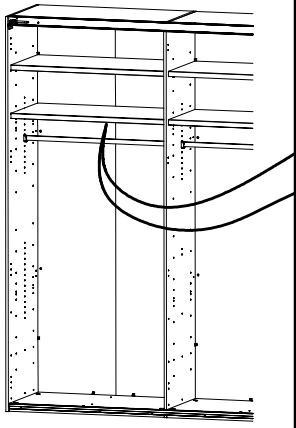
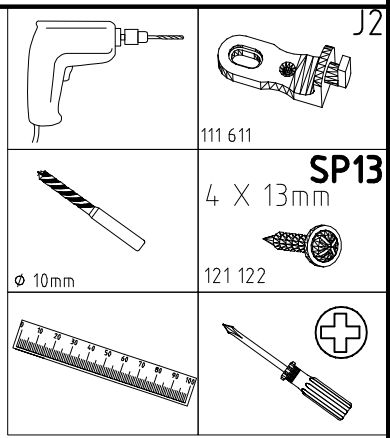
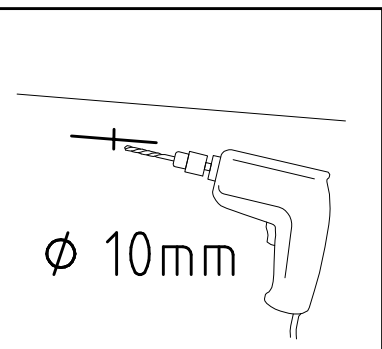
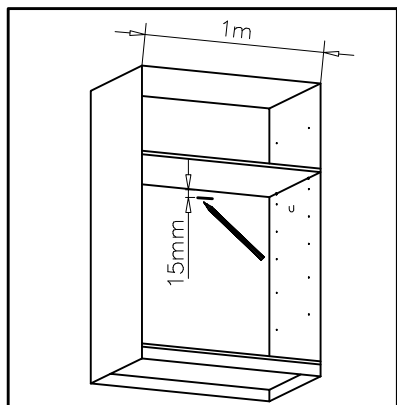

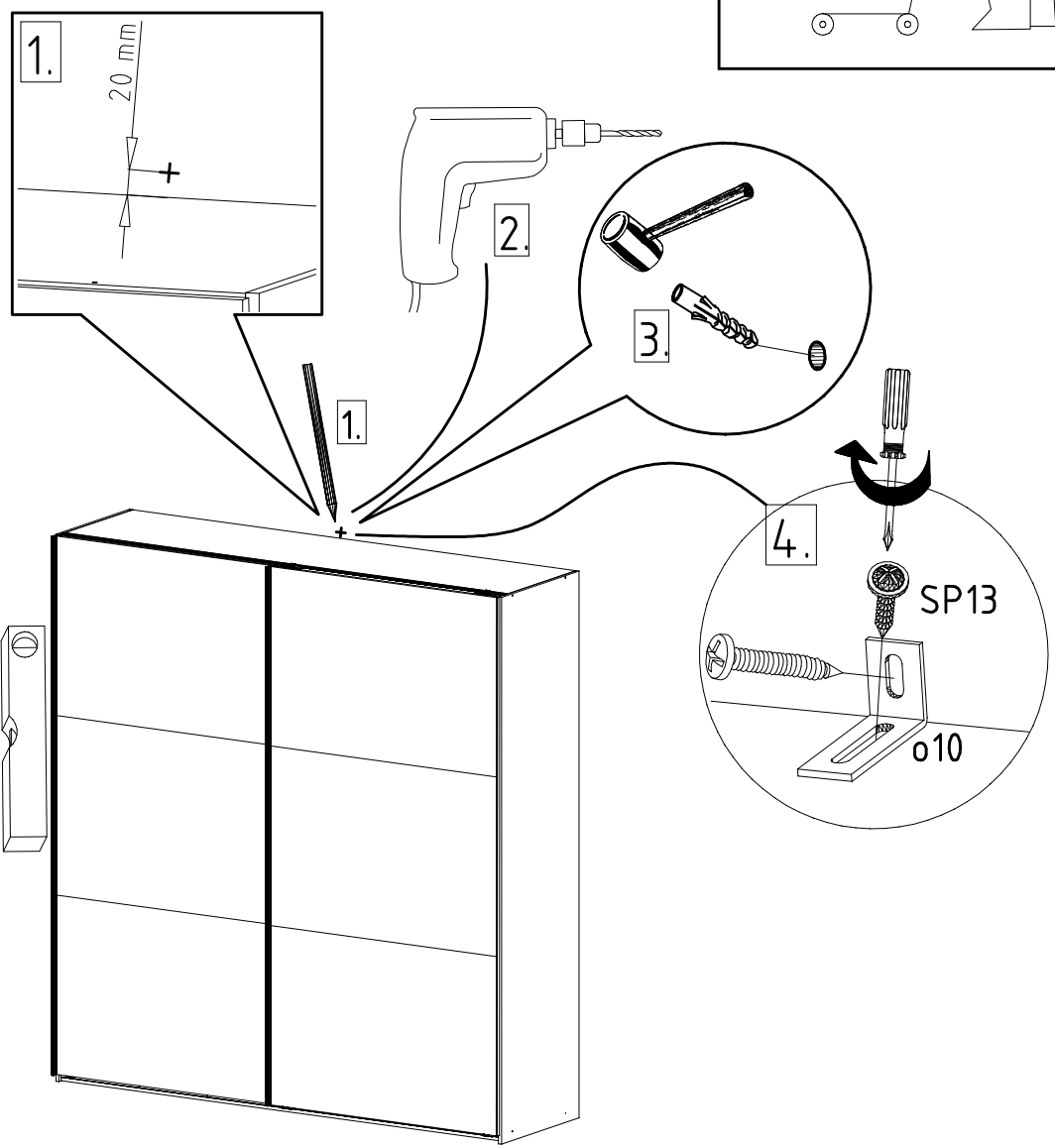
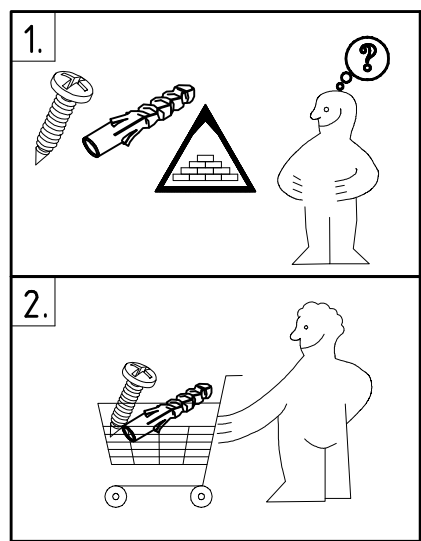
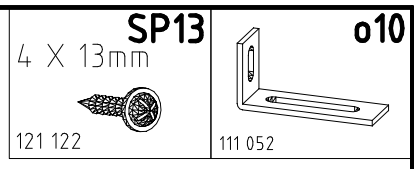
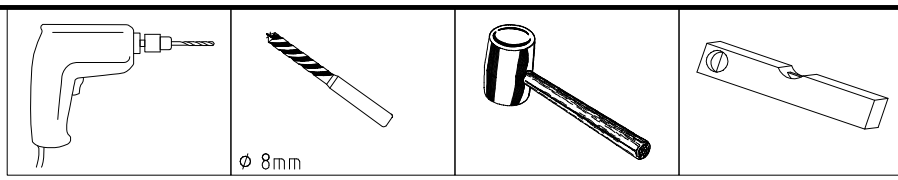

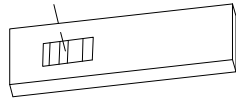
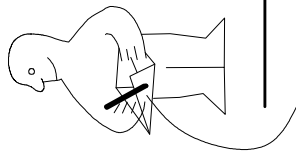
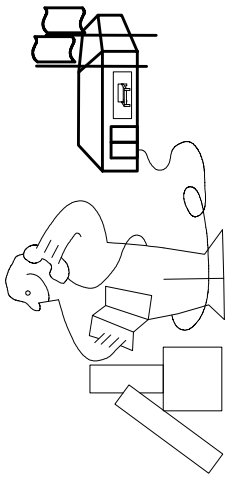
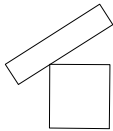
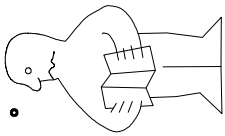

Modell/Model/Modèle



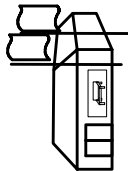

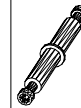
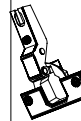
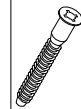

{121 370}	{ G 1 }	{4x}

Änderungen die dem technischen Fortschritt geschuldet sind, behalten wir uns vor !

Bei nicht vorschriftsmäßiger und/ oder nicht fachmännischer Montage wird bei Personen- und/ oder Sachschäden keinerlei Haftung übernommen.

WIMEX Wohnbedarf/ Import Export Handels GmbH/ Postfach 1407/ 49112 Georgsmarienhütte/ Germany
Tel.:(+49) 05401 8598 72 Fax.:(+49) 05401 8598 33 Mail: service_H@wimex-online.com

104P-NR. / 104P-NO. 150X-NR. / 150X-NO. Auftrag/Order-No. / No. de Commande

23203 **30110XY** 104

Kunde MAX MUSTERMANN
Customer
Client

Kommission / your order reference / votre reference

3377 MINDEN

Dekor / Decor Decor / Modell / Modele

F99 **SAMPLE**

F99842 SCHWEBETUERENSCHRANK 250 CM H 216CM
PLANKENEICHE NB + RAH STEEL
PLANKENEICHE NACHBILDUNG

202320301107241476000001

Paket / Package / Paquet

414760

SOCKEL

Paket 1 von 8 Colli Kommission 10

HSP-SMT BOD 50 TEXT/TEX SOCKEL 32 FRESH TV / LF 104
SO-BOD TEXT RASTEX/ ZNBOD D18MM TX KLSTA

Montage - Anleitung Laenge 520,0 OBEREN
KS-64 Breite 568,0 OBEREN

SOCKEL32 KLEB

Bei Warenauslieferung für Rückgabe beachten.
En cas de livraison de marchandises veuillez retourner le bordereau d'envoi.



OBEREN 5 30/19 HAUT 23.08.19 OBEREN 1 1. JABOVE OBEREN



WIMEX Wohnbedarf
Import Export Handelsges mbH & Co. KG
Werner-von-Siemens-Str. 35
D-49124 Georgsmarienhütte - Germany

SAMPLE **23.08.19**
Modellname Produktionsdatum
Model Date of manufacture

