

Servicekarte / Service card

Modelname / Model name

BA-0664

Hochschrank I, 2 Türen, 2 Fächer

Wildeiche massiv geölt /

Tall cabinet I, 2 doors, 2 compartments, solid

wild oak, oiled

Modelnummer / Model No.

1016662

Ausführung / Design

Eiche / oak

71107

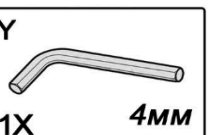
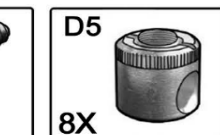
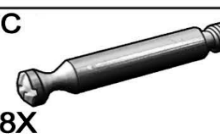
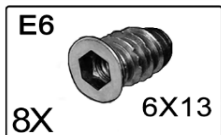
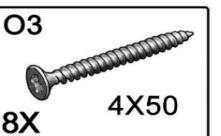
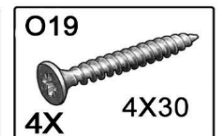
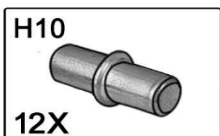
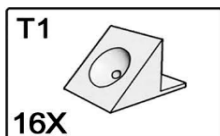
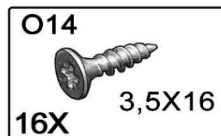
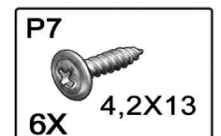
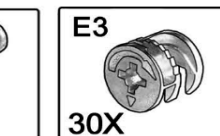
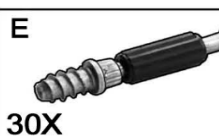
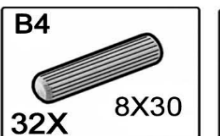
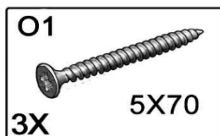
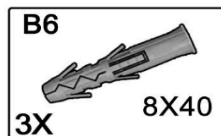
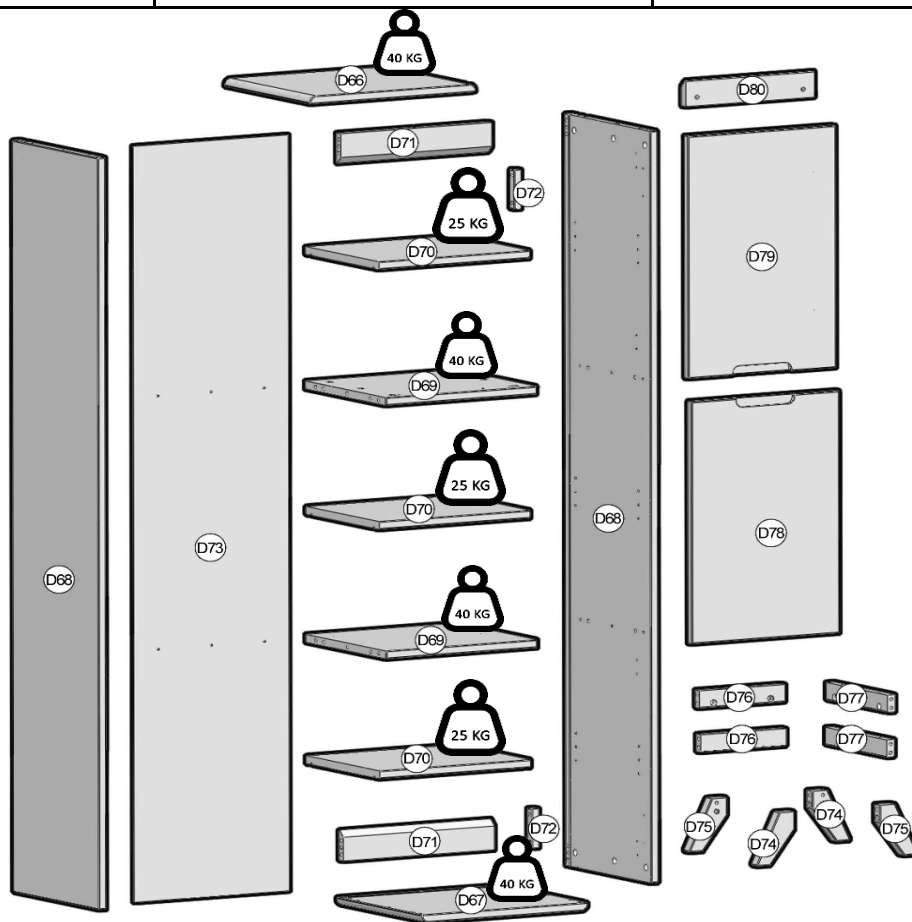

Grund der Beanstandung:

reason for complaint:

Name:

name:

Strasse:

street:

Postleitzahl:

postal code:

Telefonnummer:

telephone number:

Ort:

place:

HausNr.:

house number:

DE: Sehr geehrter Kunde, Sehr geehrte Kundin!

Fehlt Ihnen ein **Beschlagteil** oder ist es Defekt? Kein Problem! Nutzen Sie unsere Servicekarte!

Unser Direkt-Bestellservice für fehlende/defekte Beschlagteile:

Kontaktieren Sie uns telefonisch unter Tel. **+499503/5033-114** oder senden Sie uns eine E-Mail an kundendienst@3s-frankenmoebel.de. Bitte geben Sie dabei folgende Pflicht-Informationen an: -> Auftragsnummer, Artikelnummer, Nummer des Beschlagteils, fehlende/defekte Menge, und den Grund der Beanstandung, ob es sich um ein defektes oder fehlendes Beschlagteil handelt. Tragen Sie die benötigte Menge ein. Mailen Sie uns die vollständig ausgefüllte Servicekarte zu, um die Bearbeitung zu ermöglichen. Für **andere** Beanstandungen / Beschädigungen an Ihrem Möbelstück wenden Sie sich bitte **direkt an Ihr Möbelhaus**.

EN: Dear customer!

Are you missing a **fitting part** or is it defective? No problem! Use our service card!







Our direct ordering service for missing/defective fitting parts:

Contact us by telephone on **+499503/5033-114** or send us an e-mail to kundendienst@3s-frankenmoebel.de.

Please include the following mandatory information: -> Order number, article number, number of the fitting part, missing/defective quantity, and the reason for the complaint, whether it is a defective or missing fitting part. Enter the required quantity.

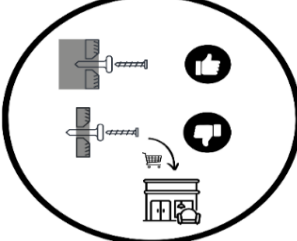
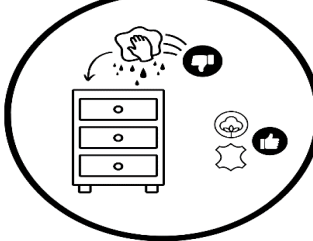
Mail us the completed service card to enable processing.

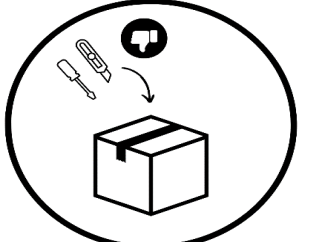
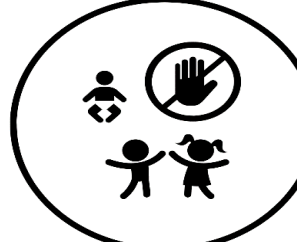
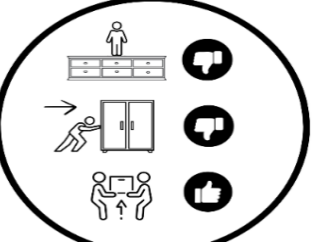
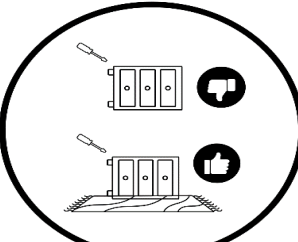
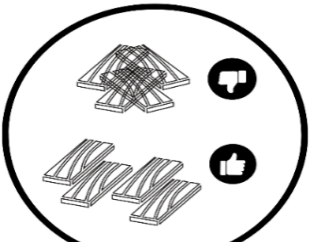
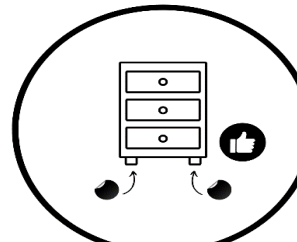
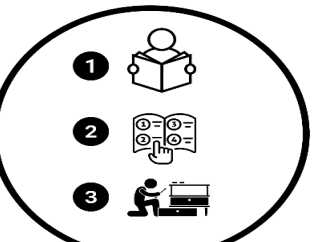
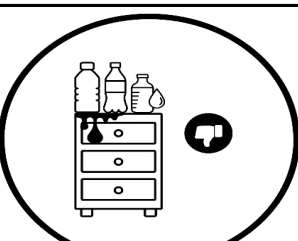
For **other** complaints/damage to your furniture, please **contact your furniture store directly**.

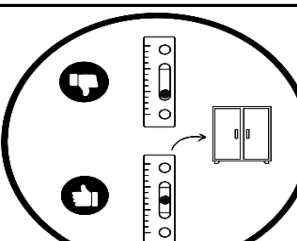
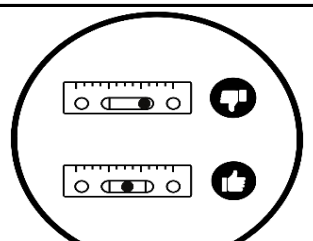

BA-0664

Hochschrank I, 2 Türen, 2 Fächer

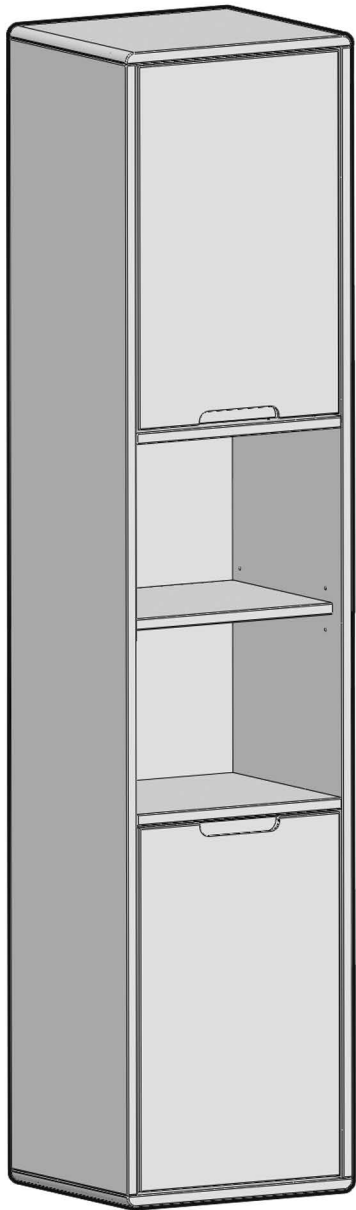

I

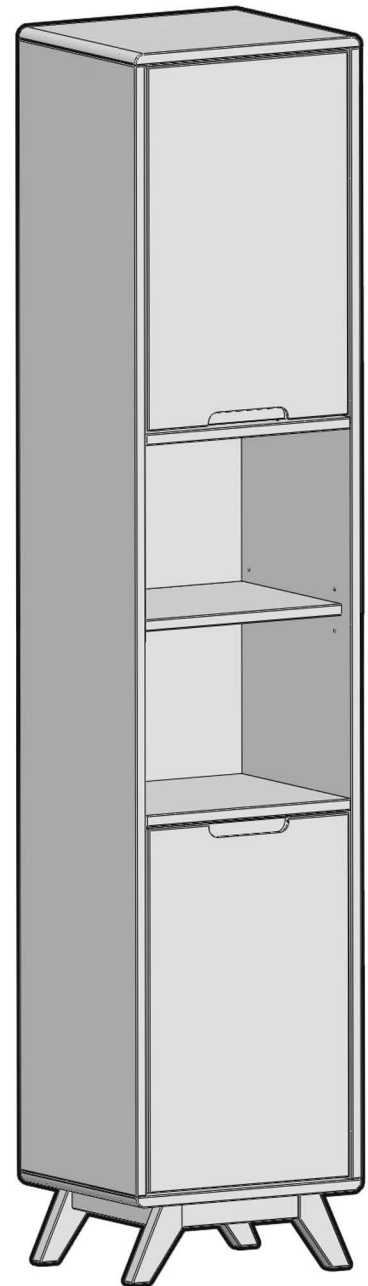

II

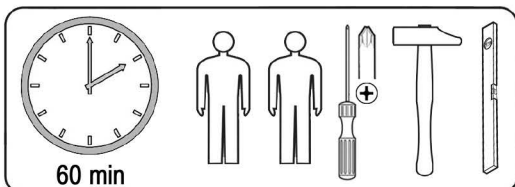
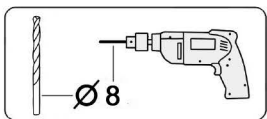

400x350x1900

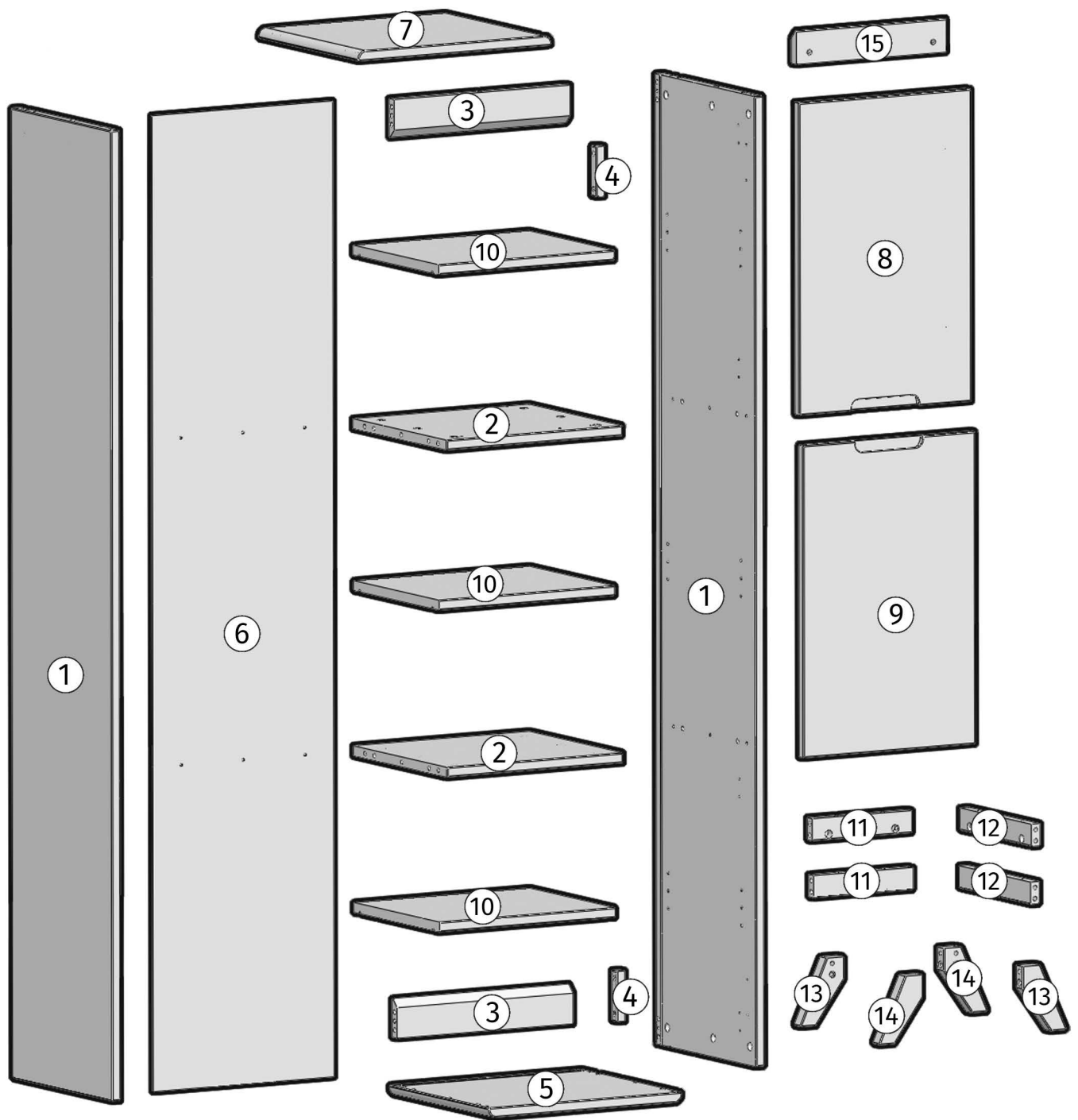
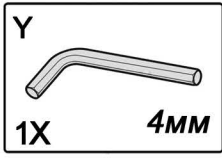
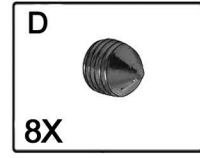
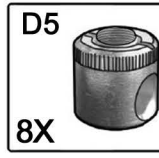
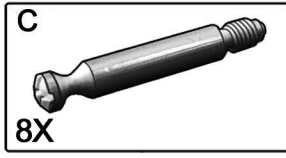
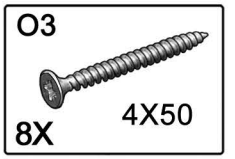
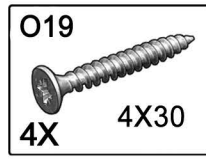
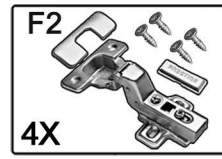
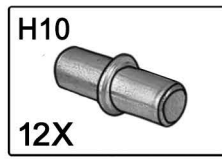
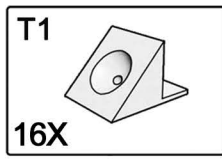
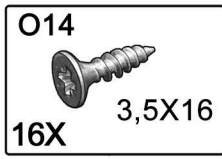
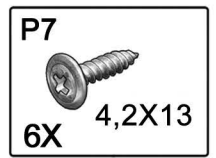
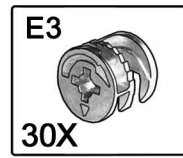
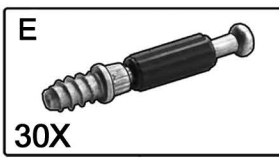
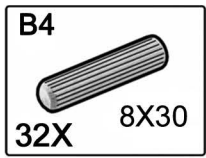
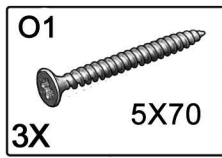
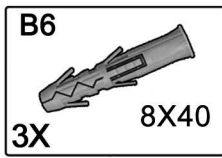

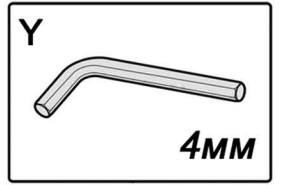
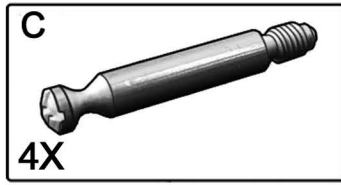
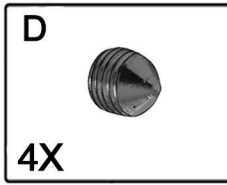
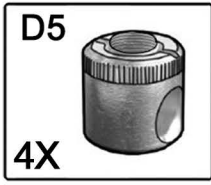
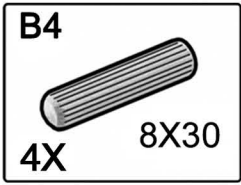

II

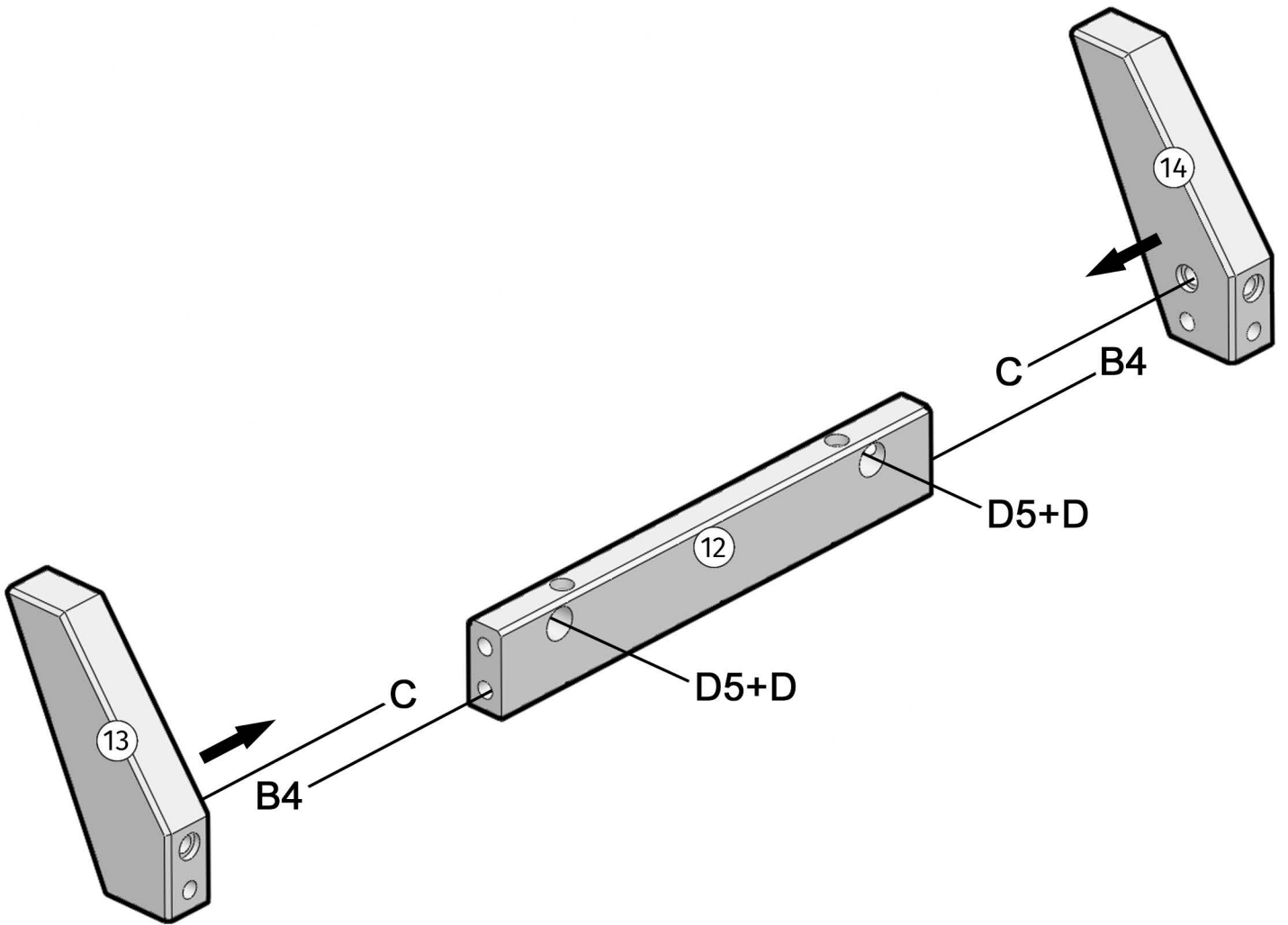

2X

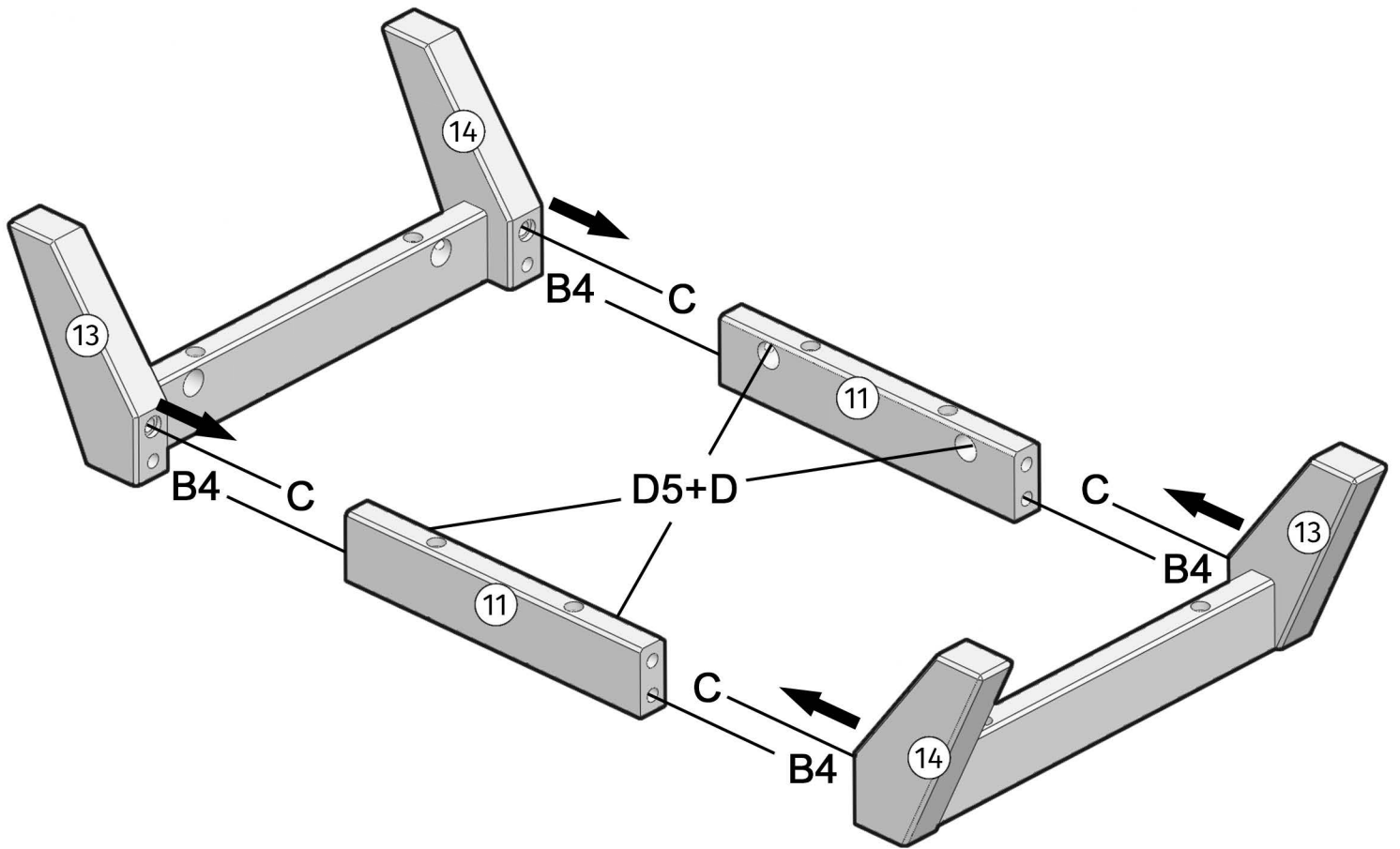
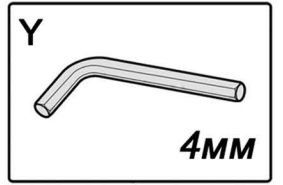
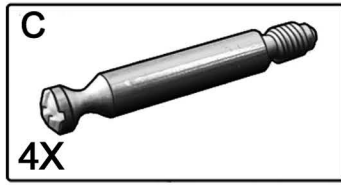
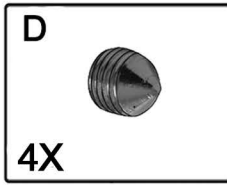
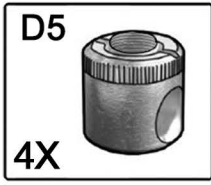
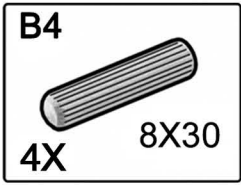

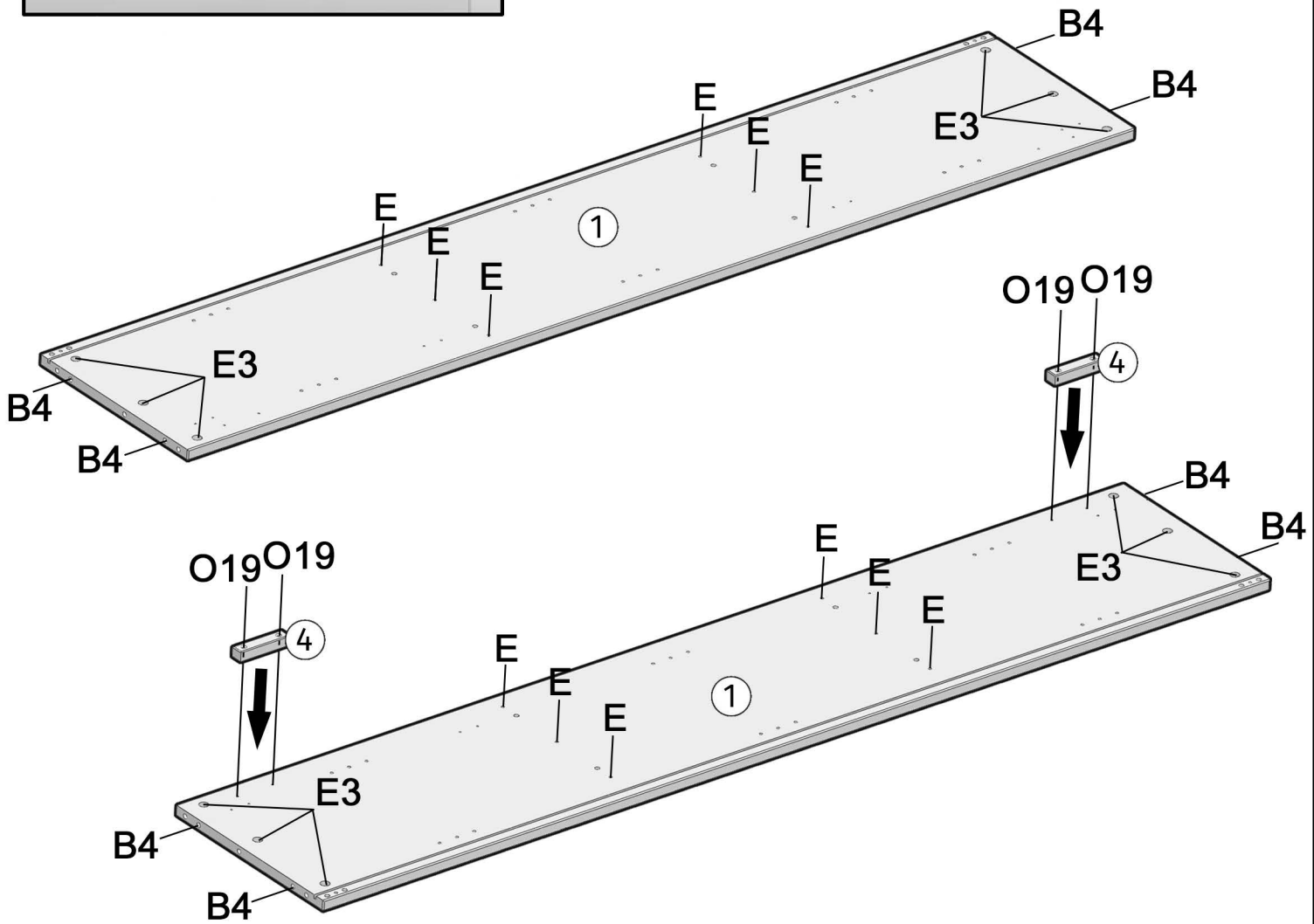
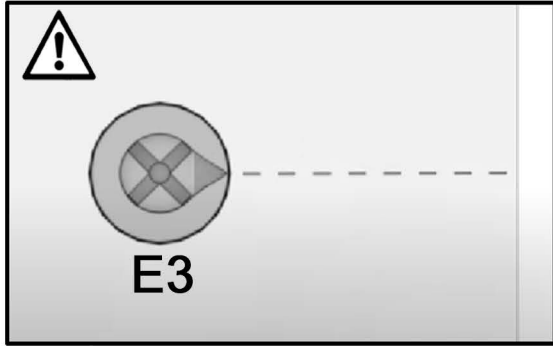
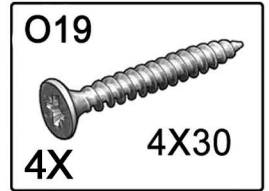
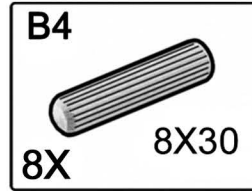
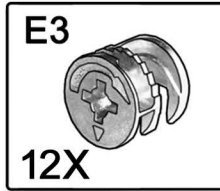
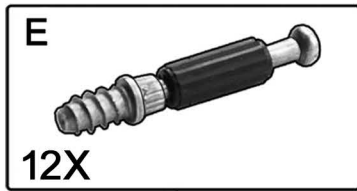

I,II

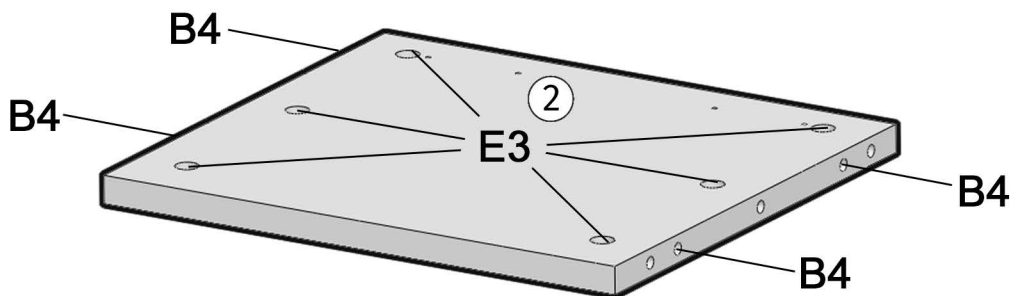
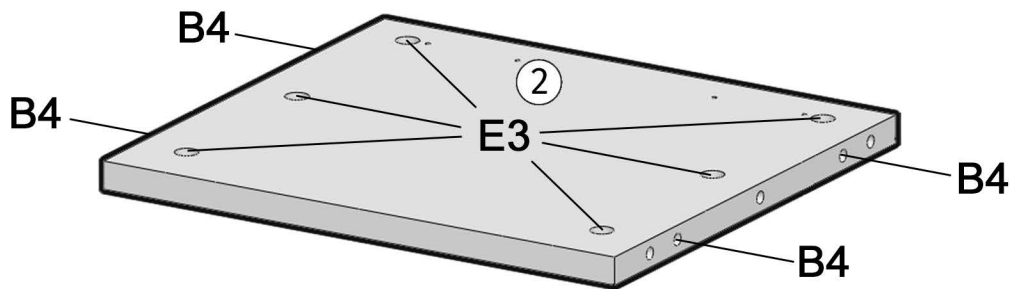
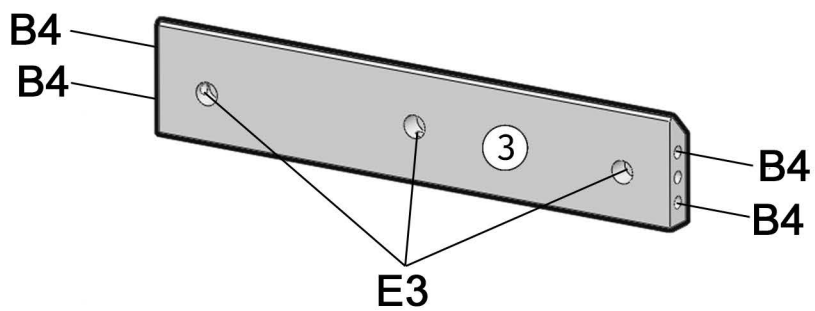
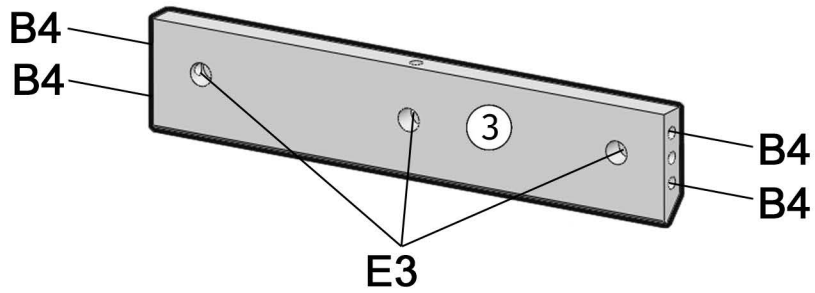
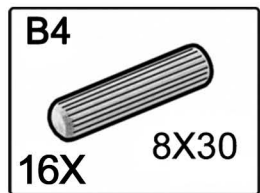
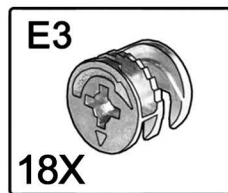
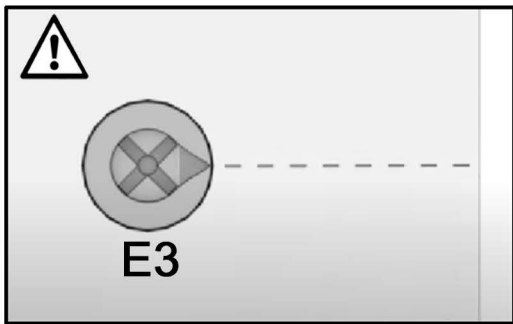

I,II

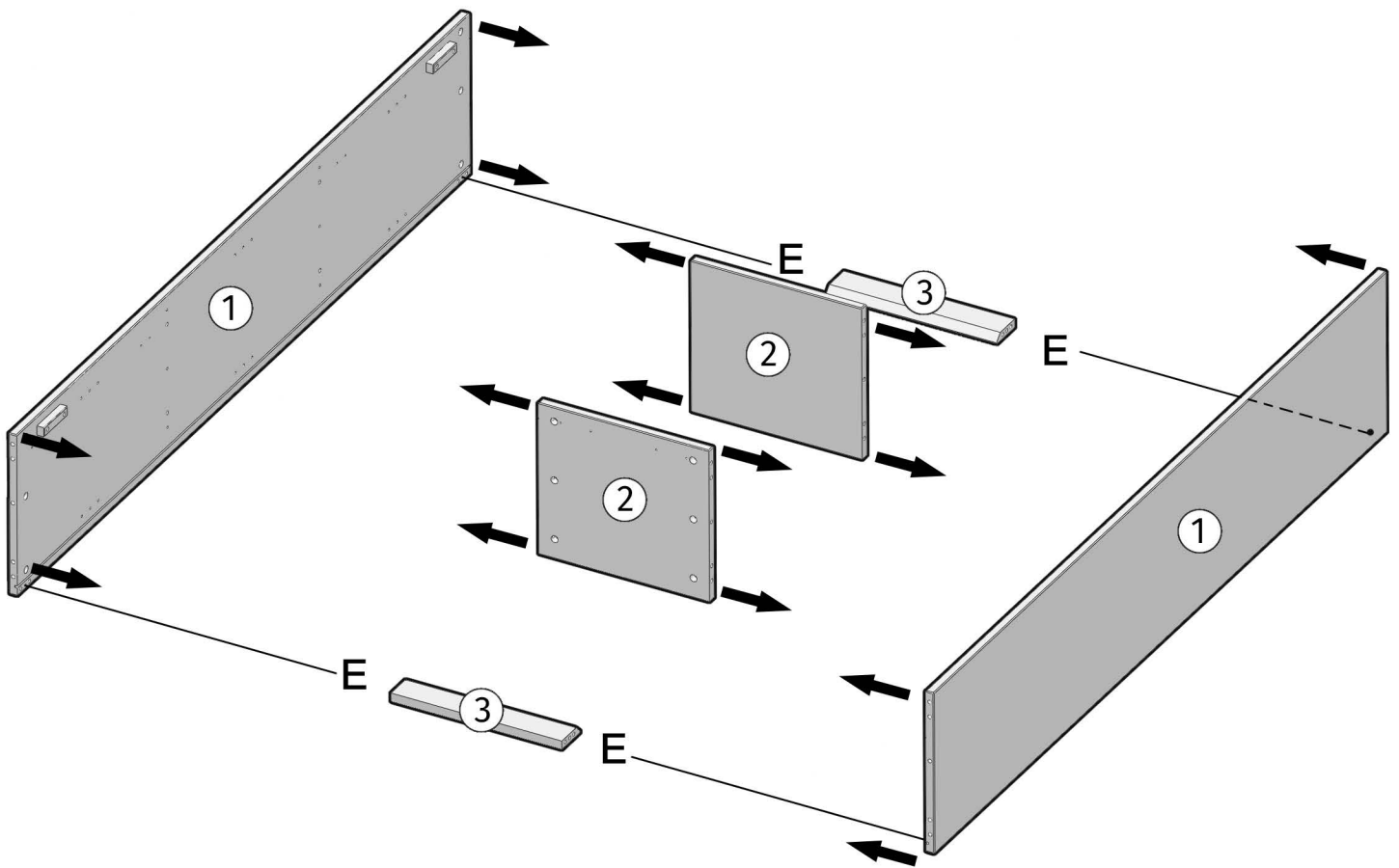
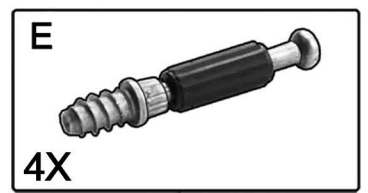
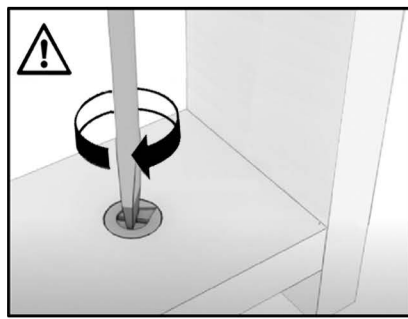
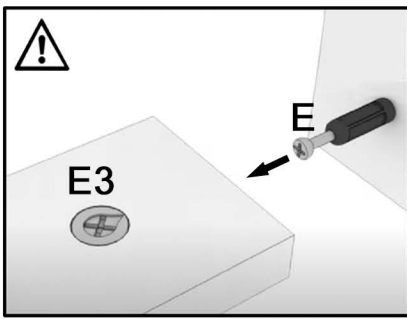

I, II

I,II

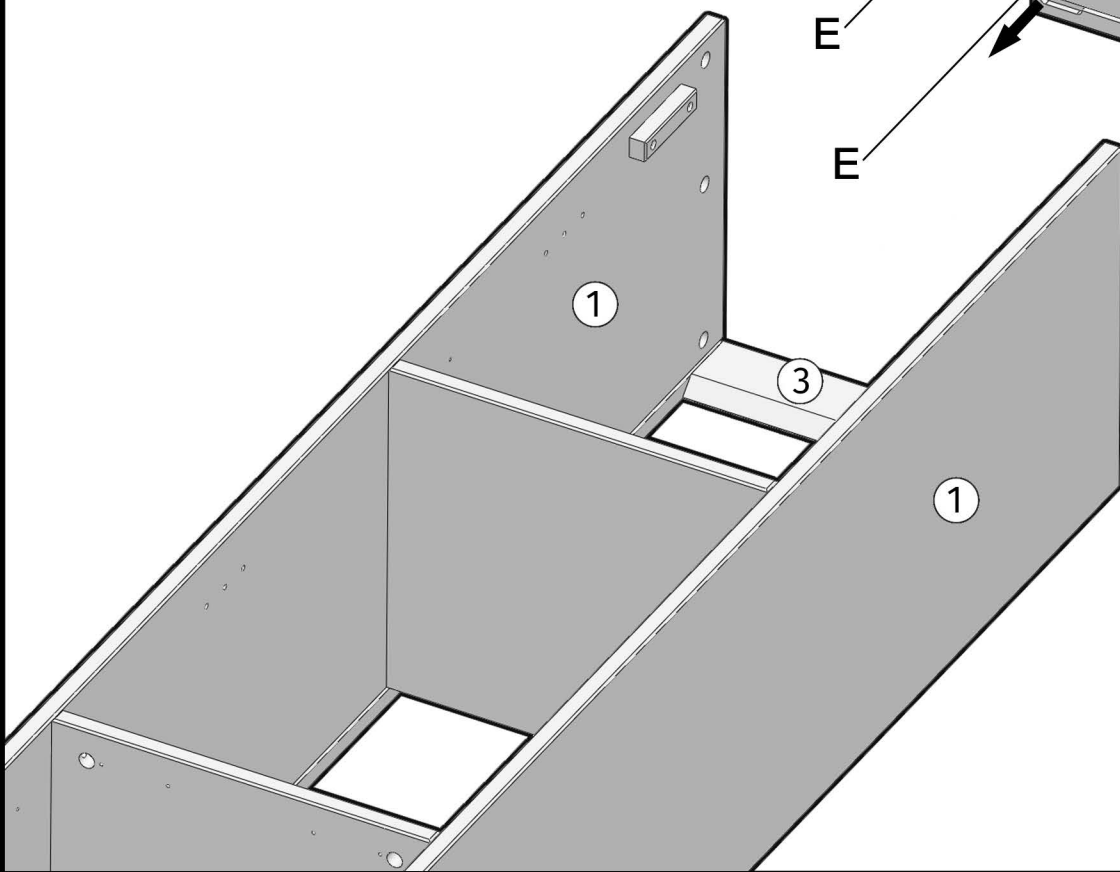
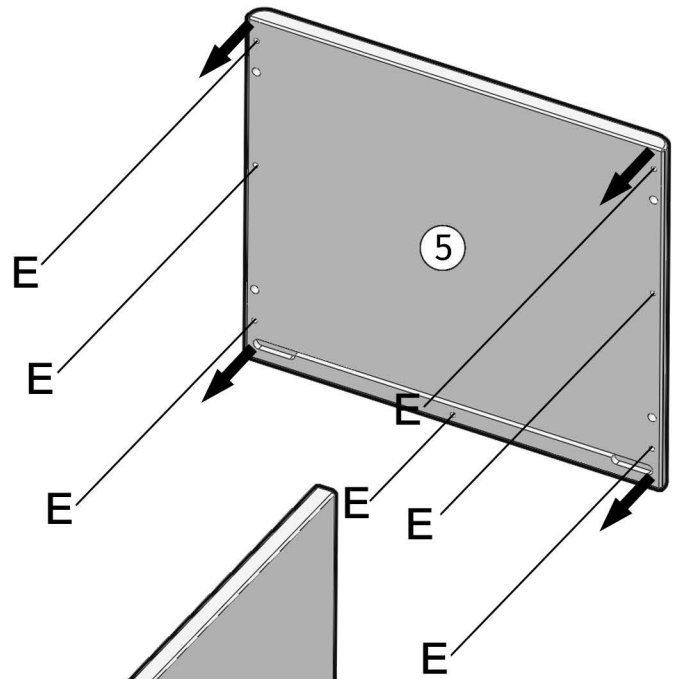
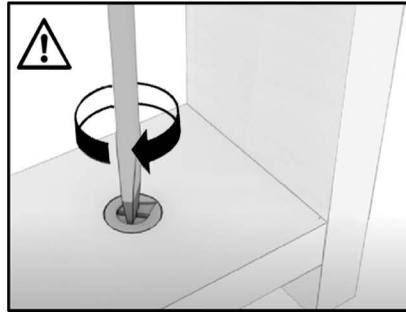
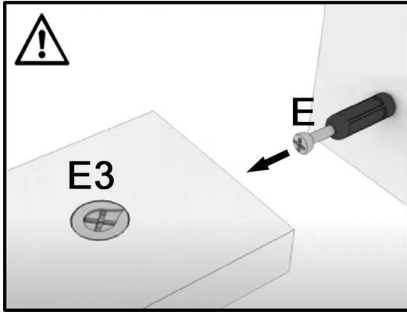
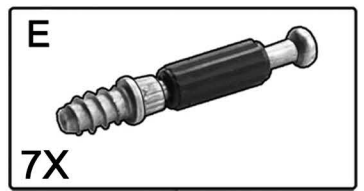

I,II

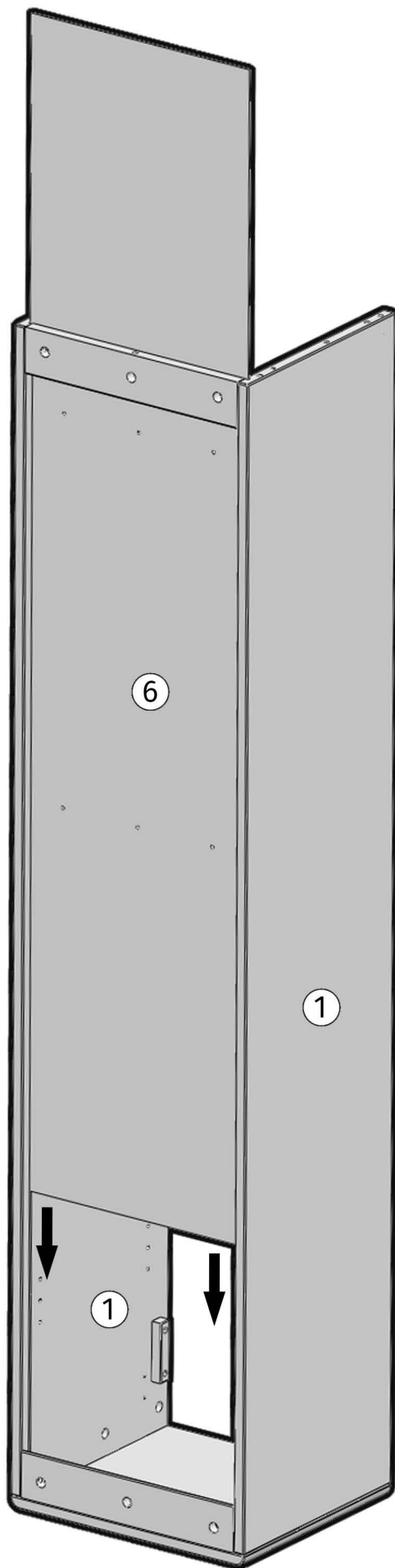

I,II

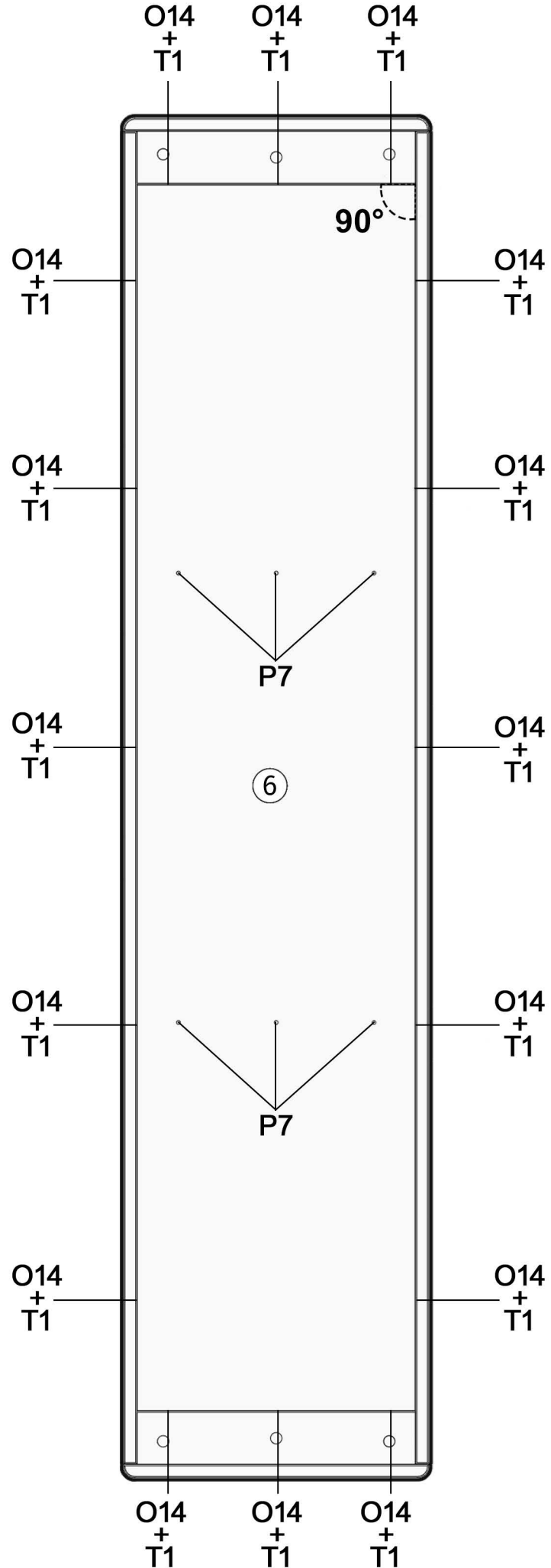
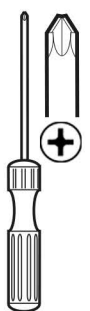
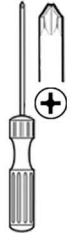
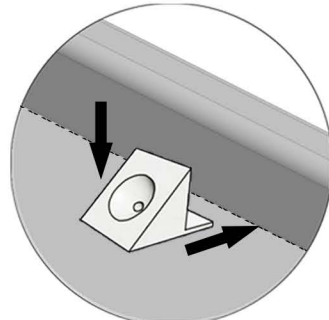
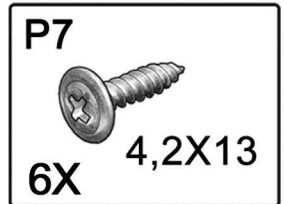
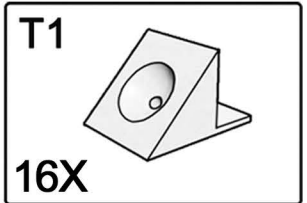
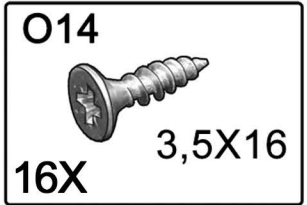

I,II

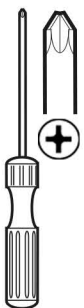
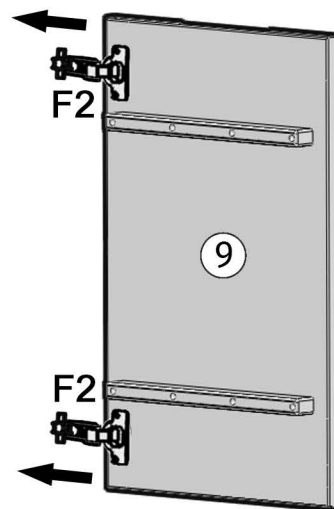
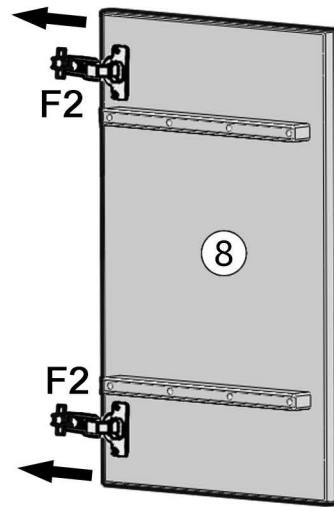
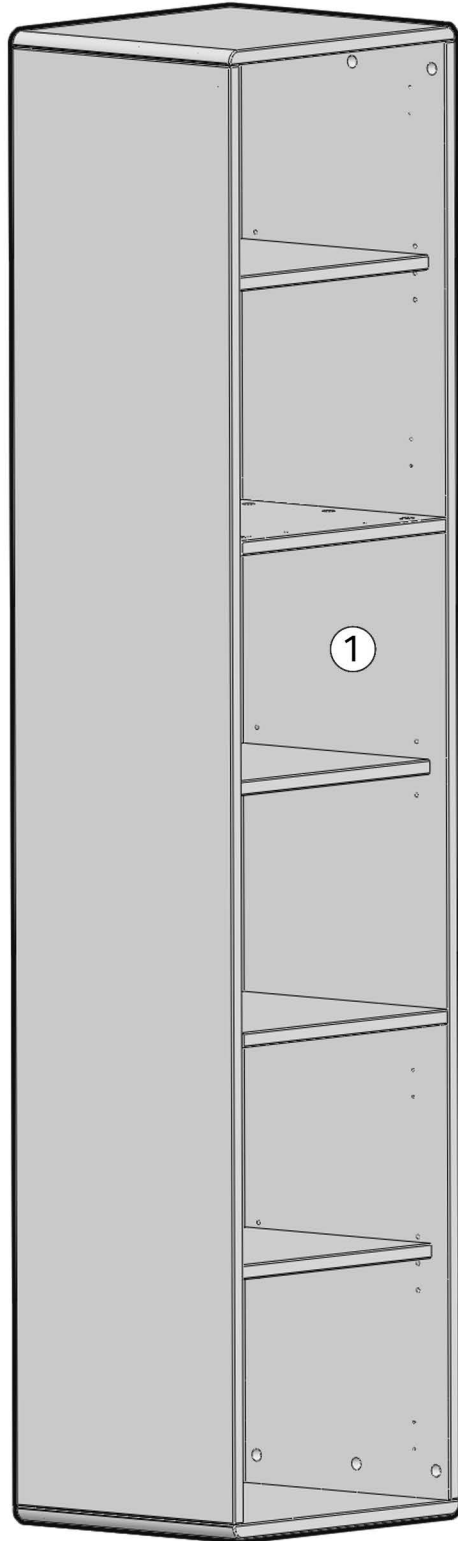
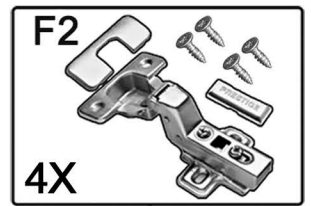

A

I,II

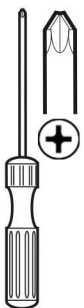
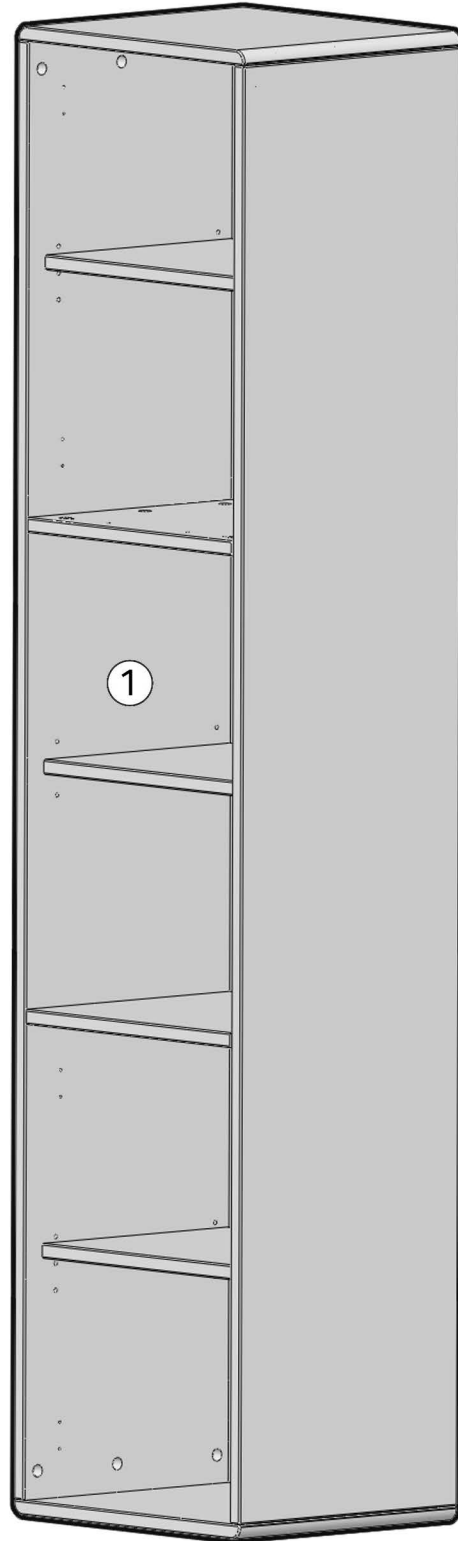
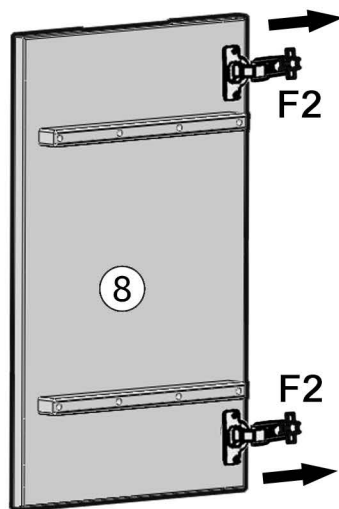
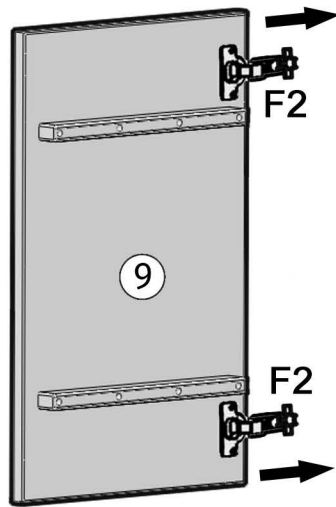
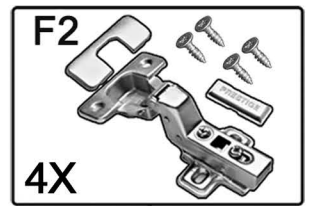

B

13/19

I,II

H10

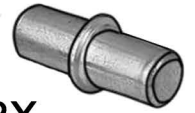

12X

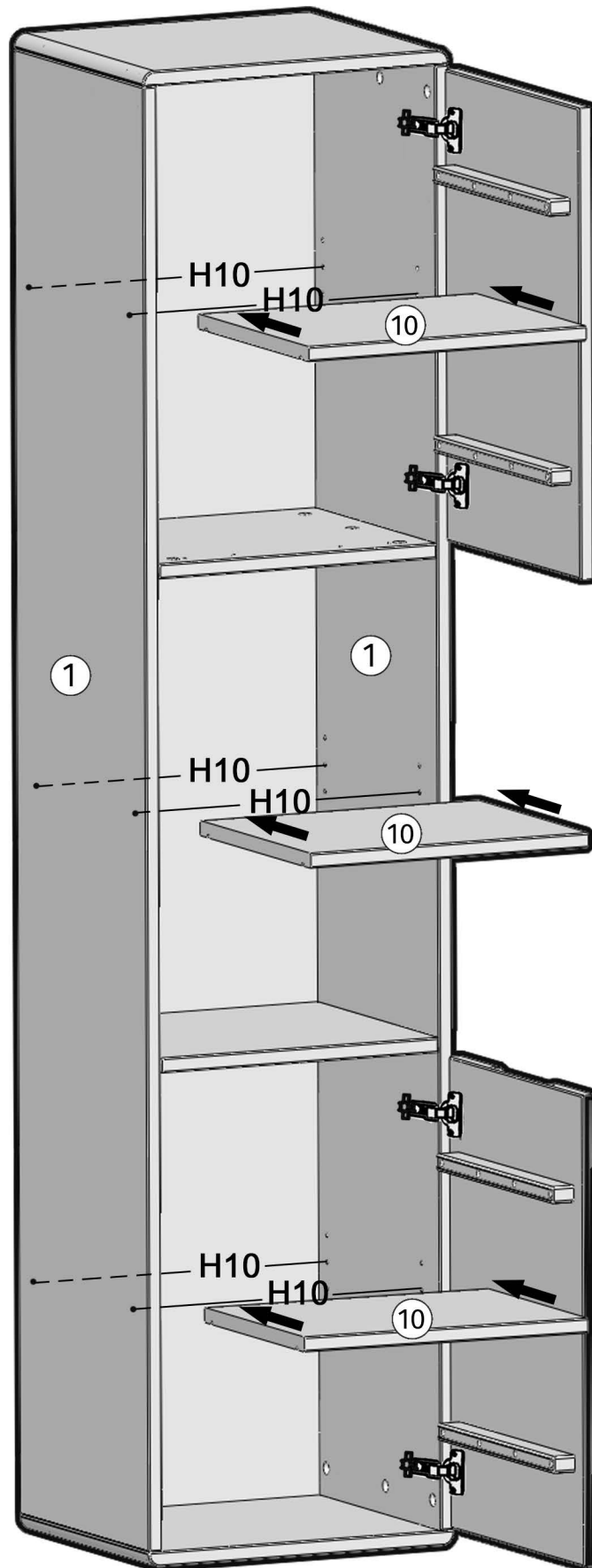

II

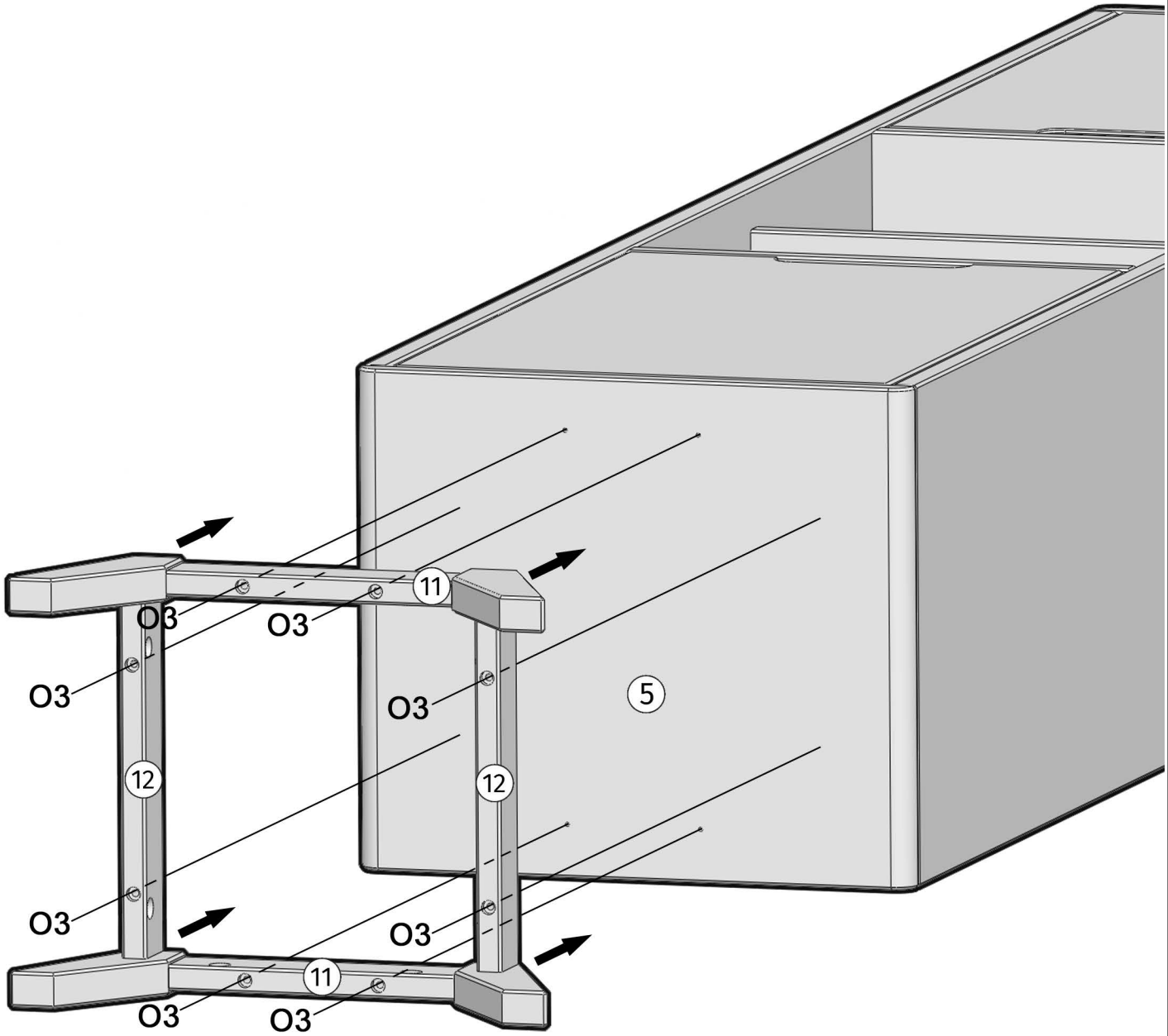
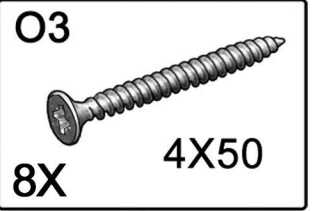

II

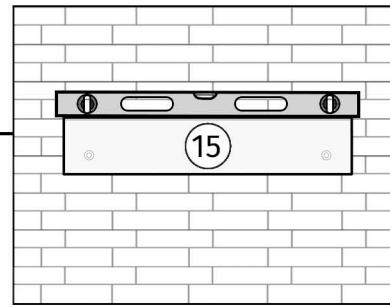

1

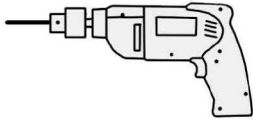

2

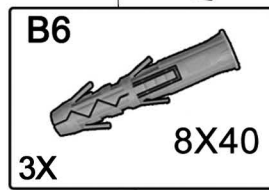
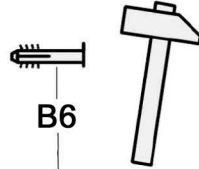

3

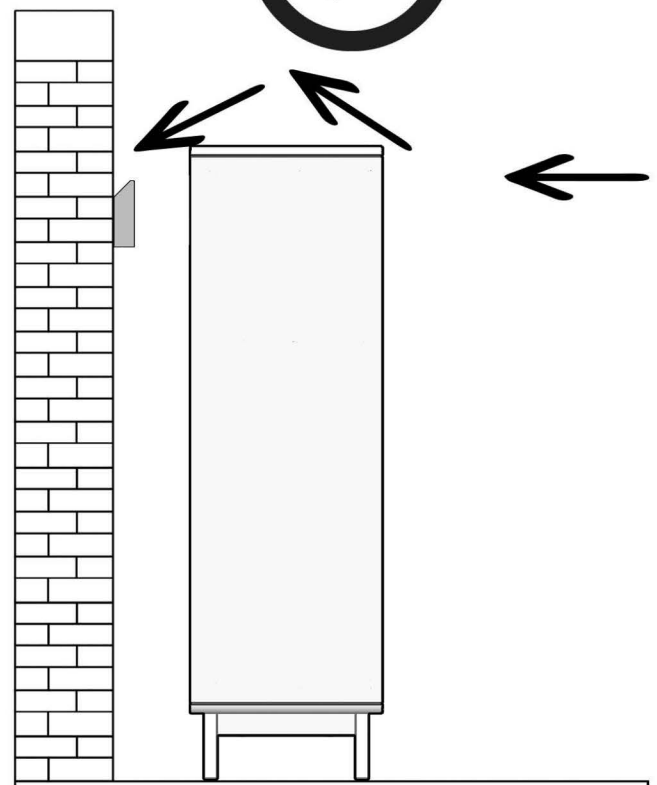
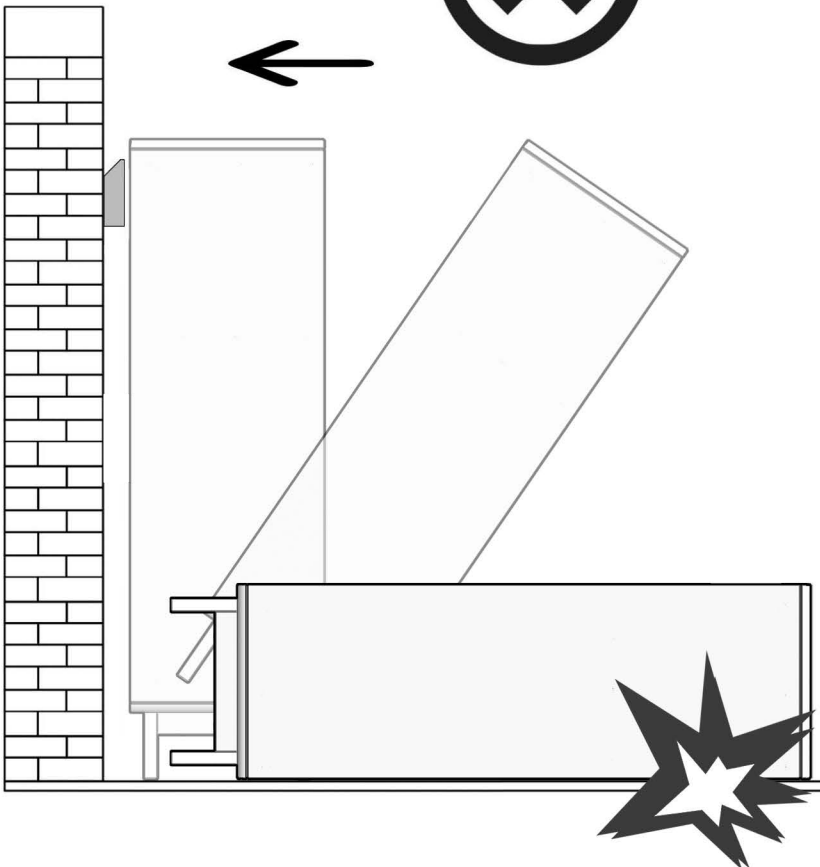
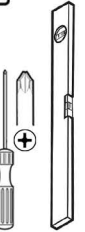
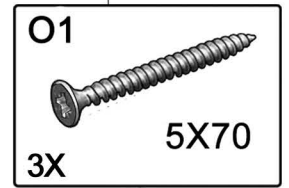
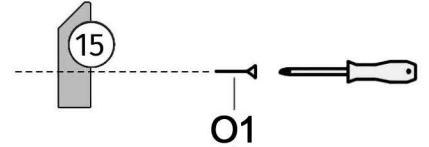

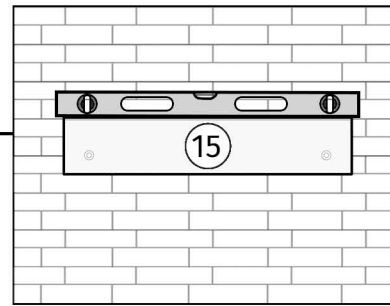

1

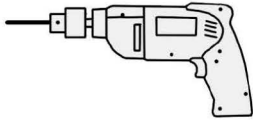

2

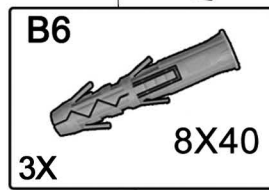
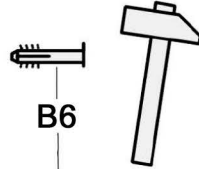

3

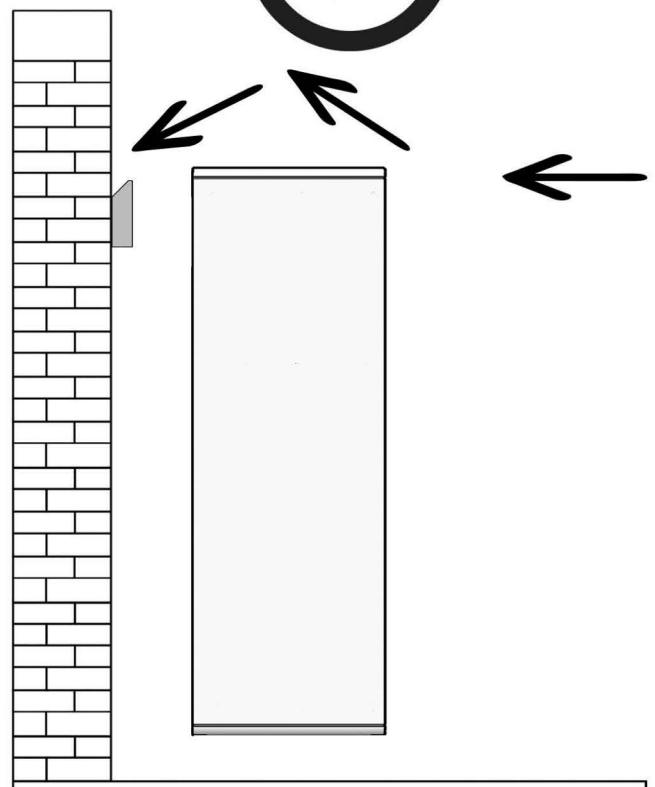
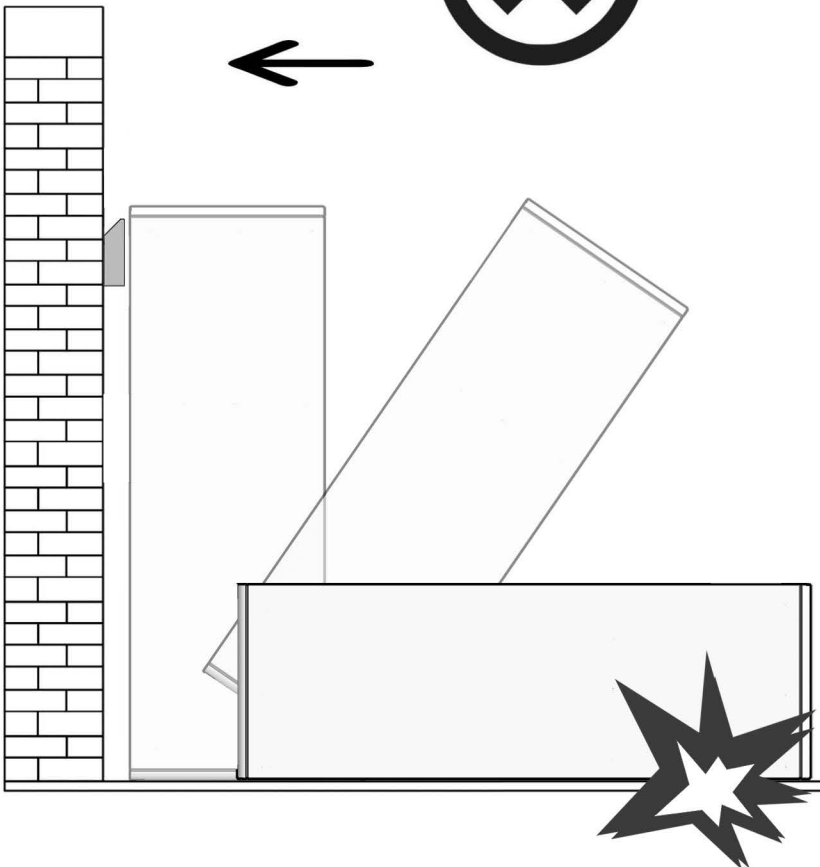
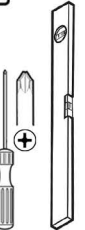
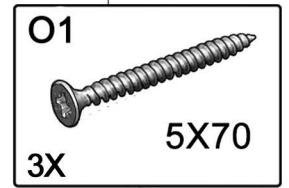
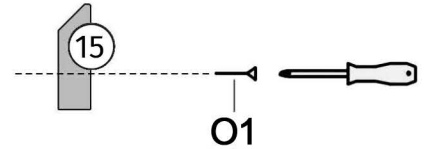

A

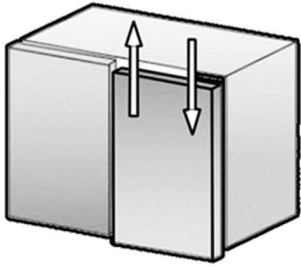

B

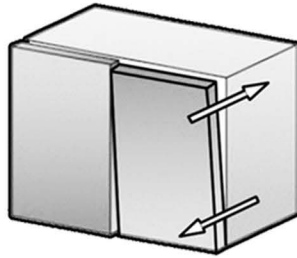

C

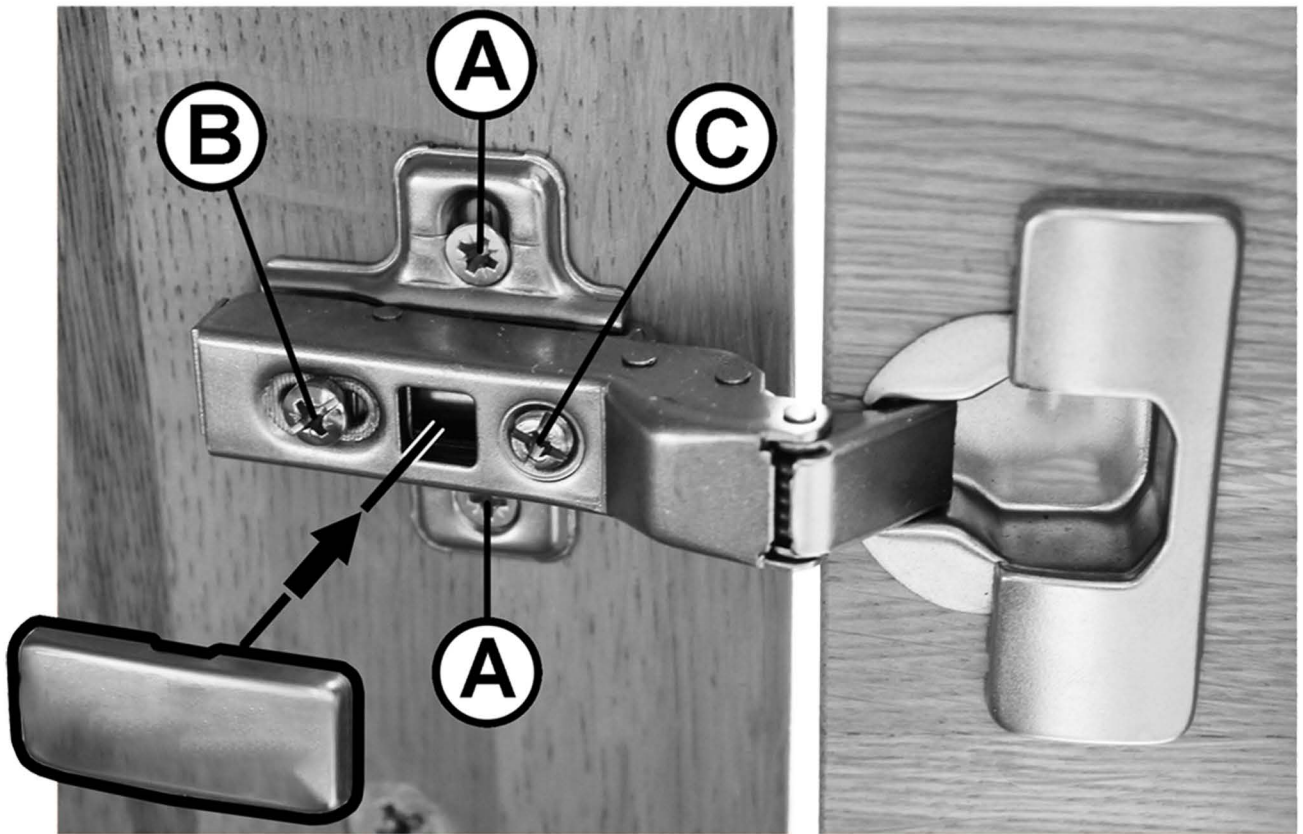
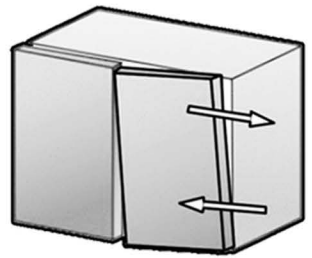

I, II

