

Montageanleitung	D
Installation Instructions	GB
Instructions d'installation	F
Montagehandleiding	NL
Istruzioni di montaggio	I
Instrukcja montażu	PL

Руководство по монтажу	RUS
Instrucțiuni de instalare	RO
Návod na montáž	SK
Návod k instalaci	CZ
Szerelési útmutató	H
Kurulum Talimatları	TR

01.2019

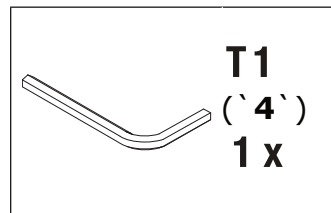
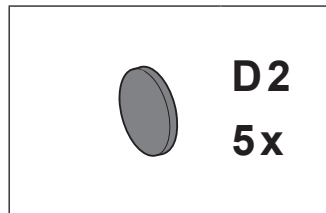
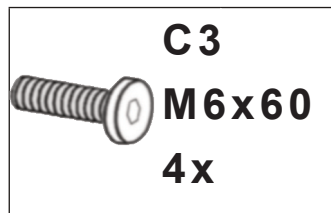
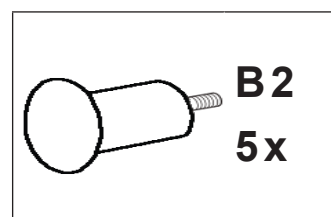
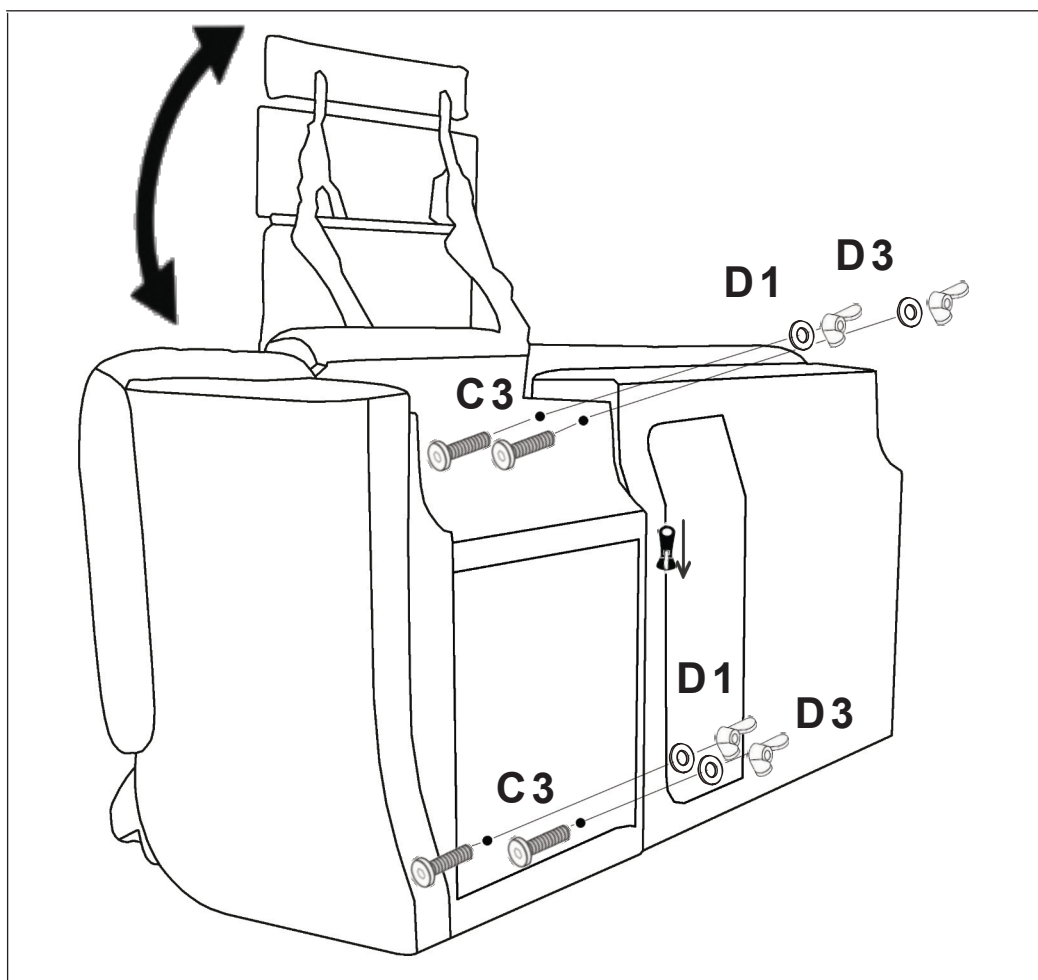
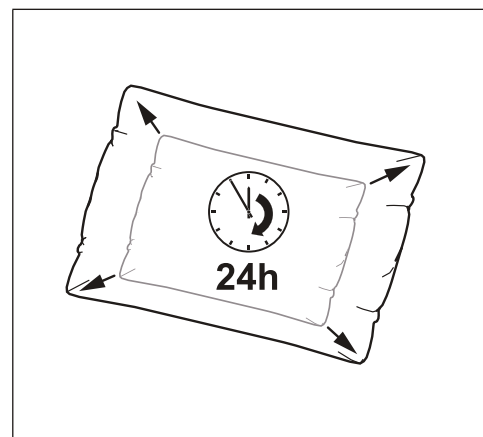
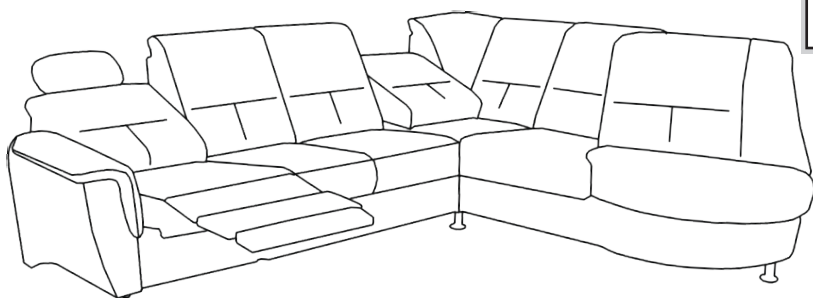

**Service • Assistenza • Dienstverlening • Serwis •
Servis • Szervis • Сервисная служба**

Name • Nom • Nome • Naam •
Nazwa • Jméno • Názov • Nev •
Denumire • Isim • Название

Тур • Type • Tip • Tipus • Tipo •
Тип

Parole

