



LOLA

Art. Nr. 14160031/05

700mm 405mm

1960mm

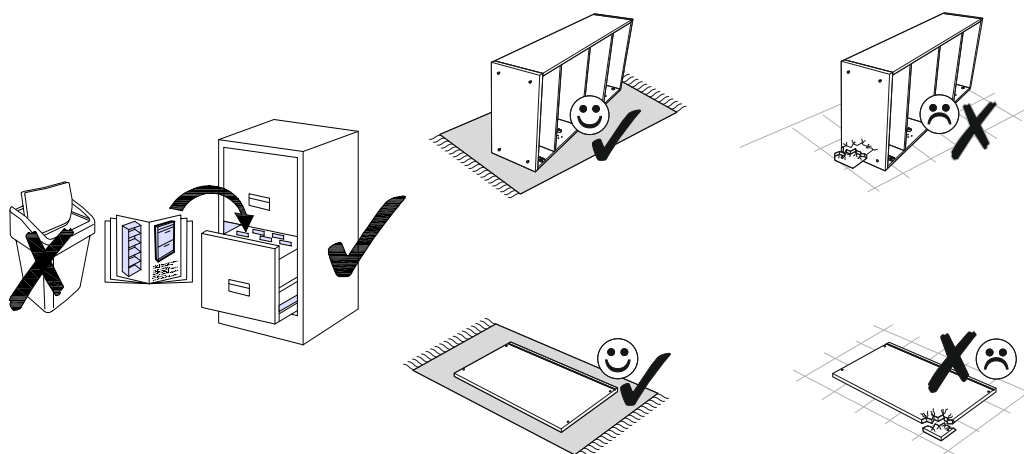
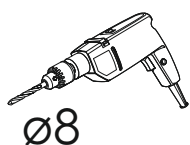
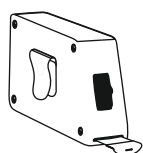
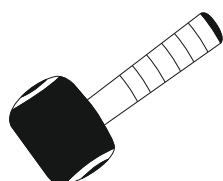
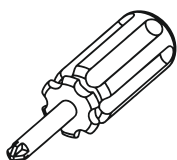
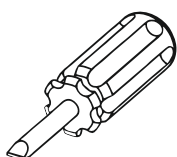
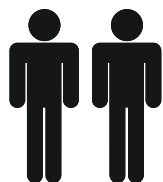
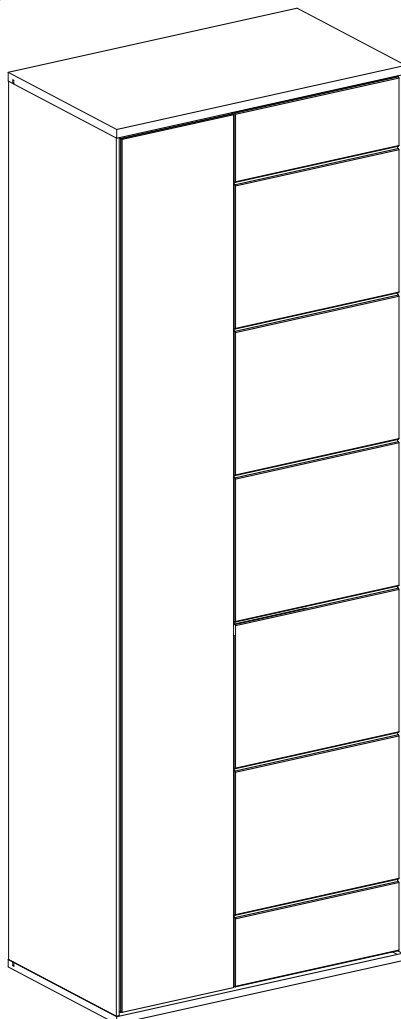

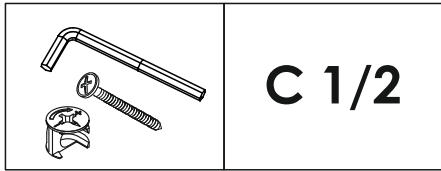



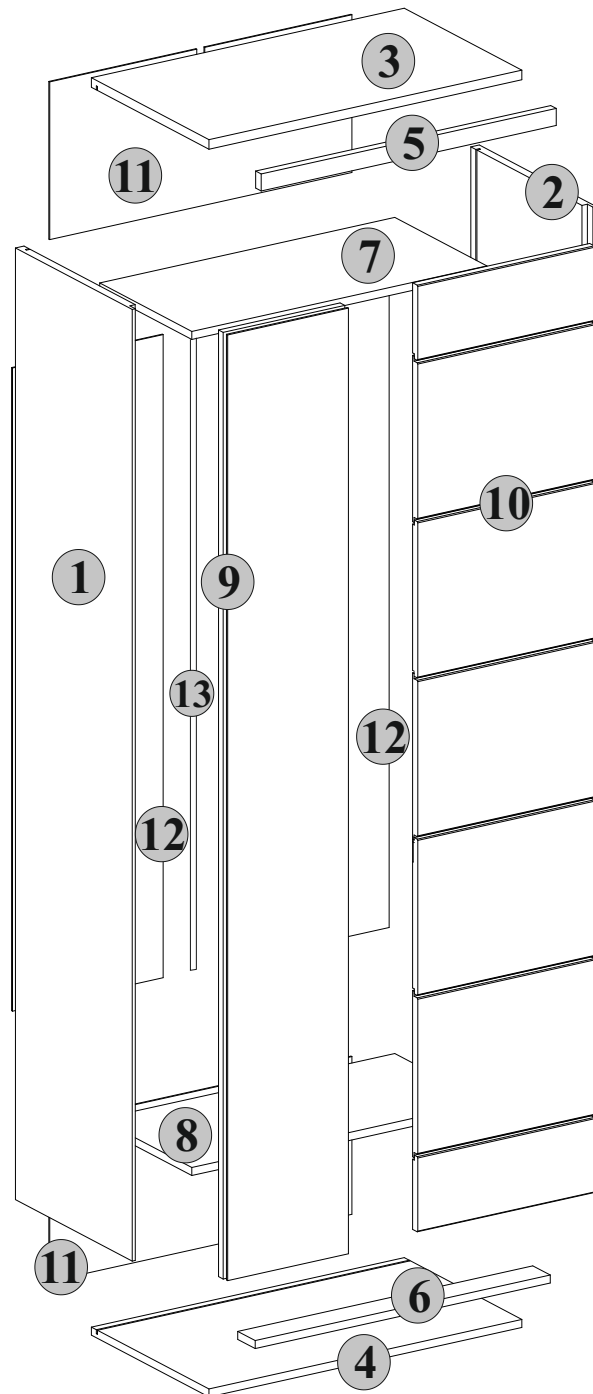



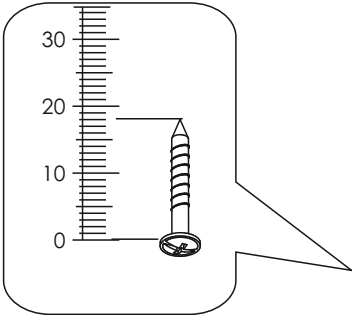
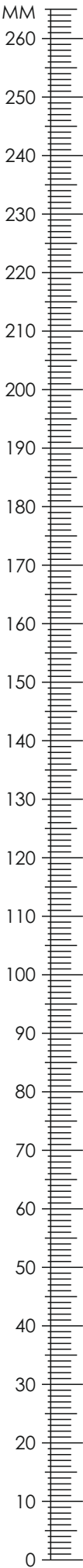





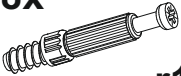
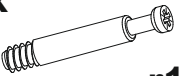



1	1900	402	19	x1	2/3
2	1900	402	19	x1	1/3
3	700	405	19	x1	1/3
4	700	405	16	x1	1/3
5	660	34	19	x1	1/3
6	660	60	16	x1	1/3
7	660	317	16	x1	1/3
8	660	317	16	x1	1/3
9	1890	272	20	x1	2/3
10	396	1890	18	x1	3/3
11	315	676	3	x2	2/3
12	1284	337	3	x2	2/3
13	2000	20		x1	2/3

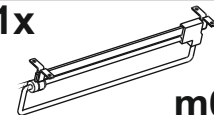
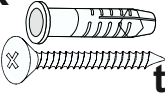
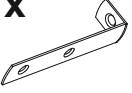

Art. Nr. 14160031/05



A	19x  s2	19x  φ15 #12.5 r1	24x  l2
	18x  r16	1x  r14	
B	18x  φ8x32 mm f1	10x  φ3.5x35 mm p80	5x  k19
	2x  φ4x30 mm p42		
C	20x  φ3.5x16 mm p1	8x  φ3.5x20 mm p4	
	8x  l9	1x  m6	
D	1x  t17	1x  n14	
	2x  φ3.5x16 mm p1		

b1  x8	a2  x8	e2  x16
---	---	--

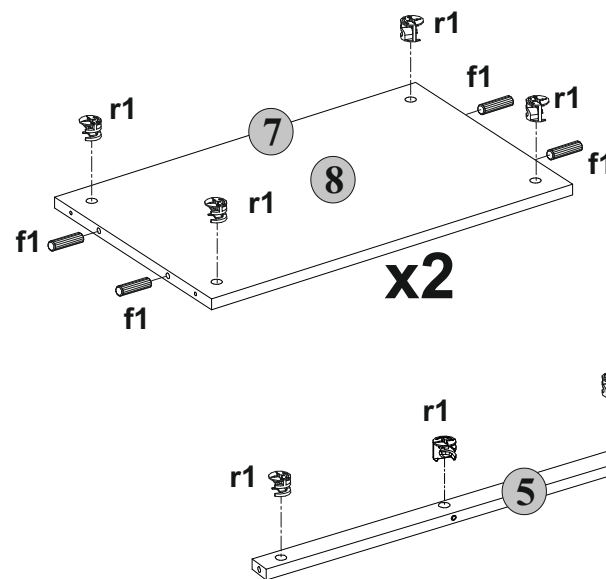
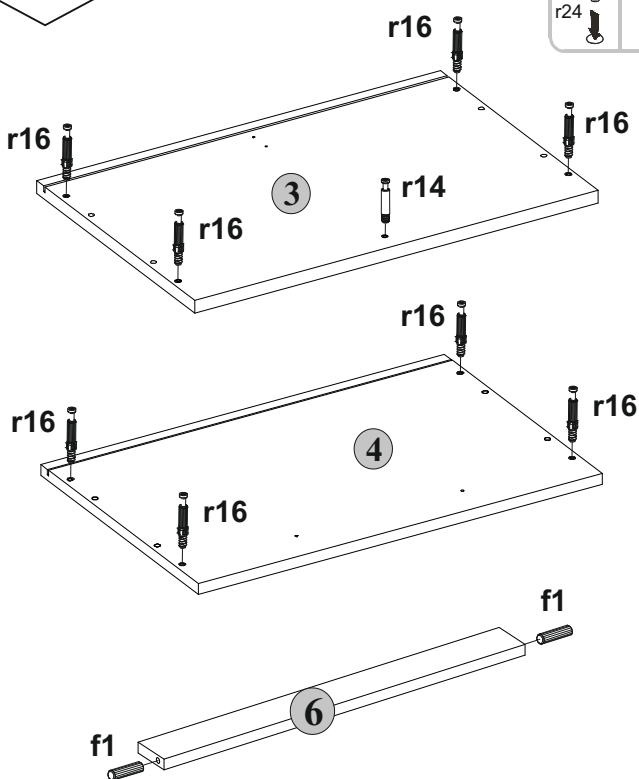
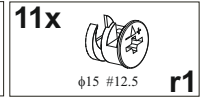
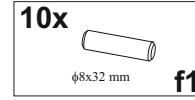
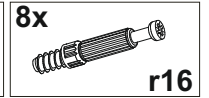
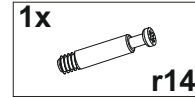
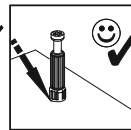
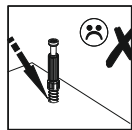
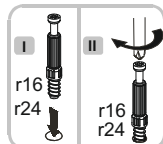
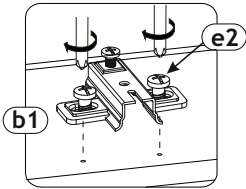
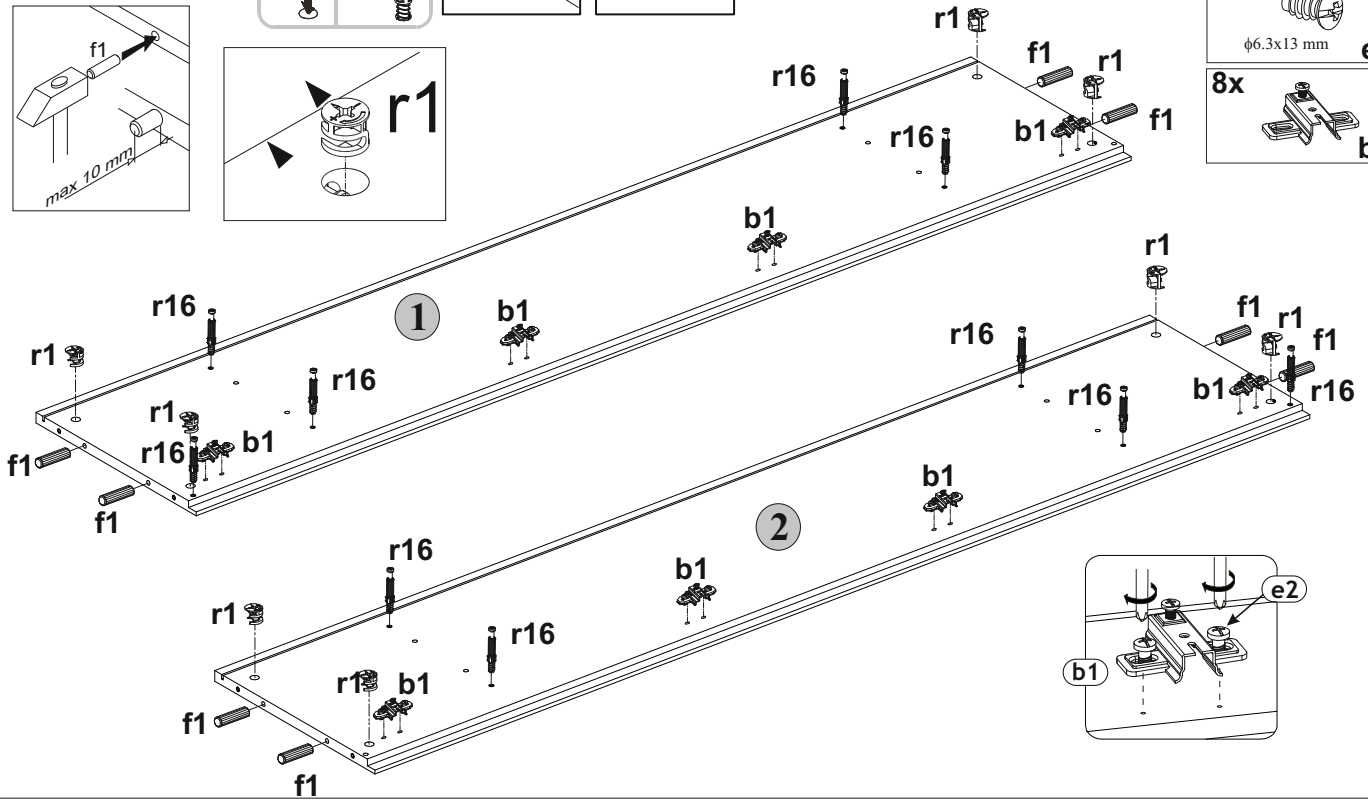
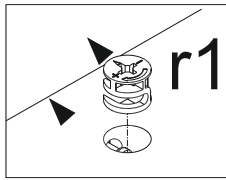
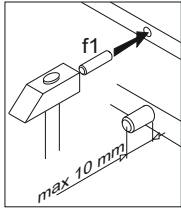
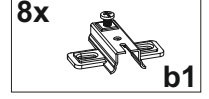
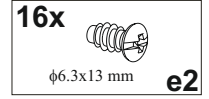
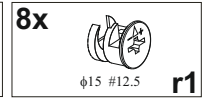
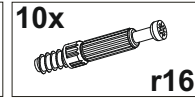
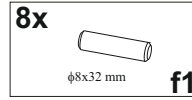
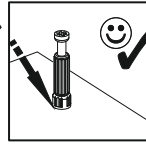
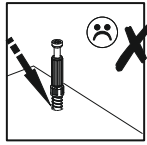
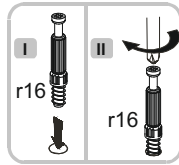
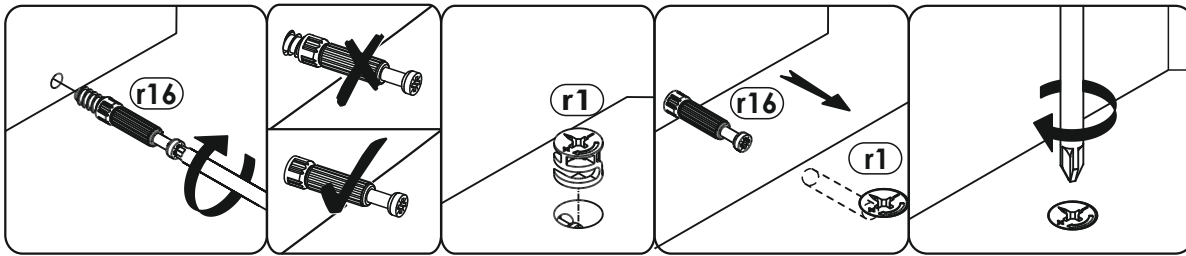

3

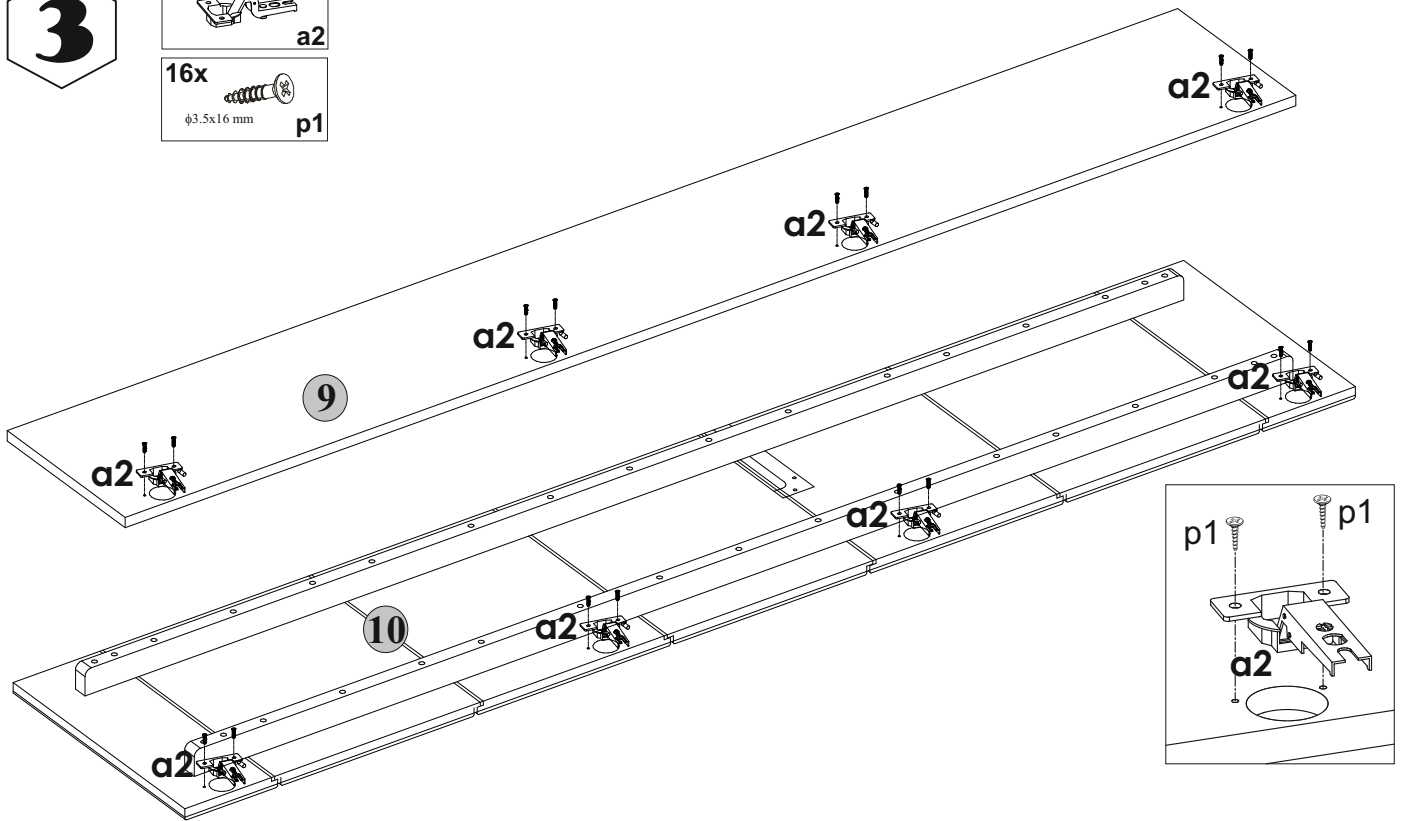
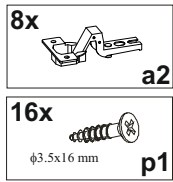

4

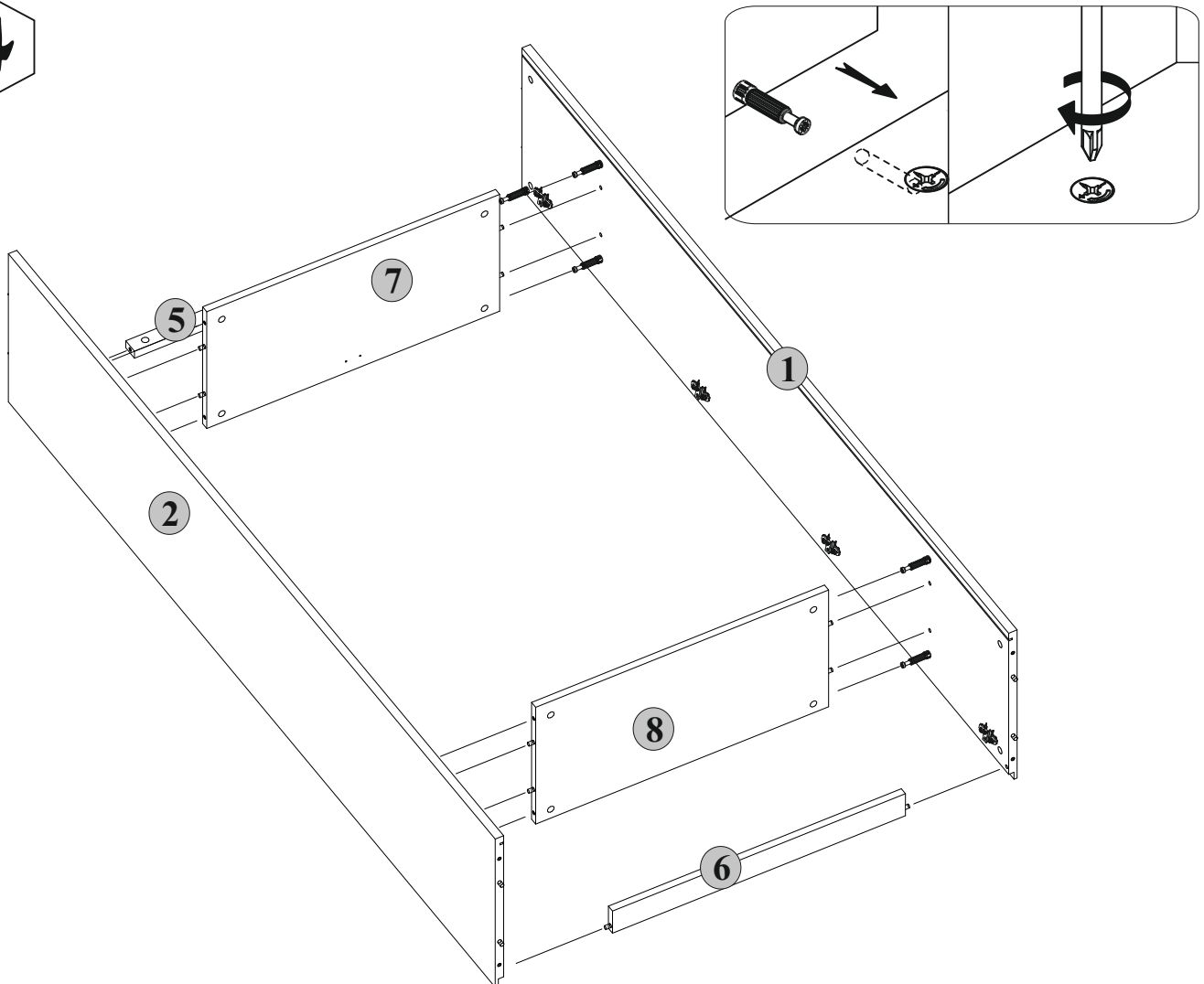



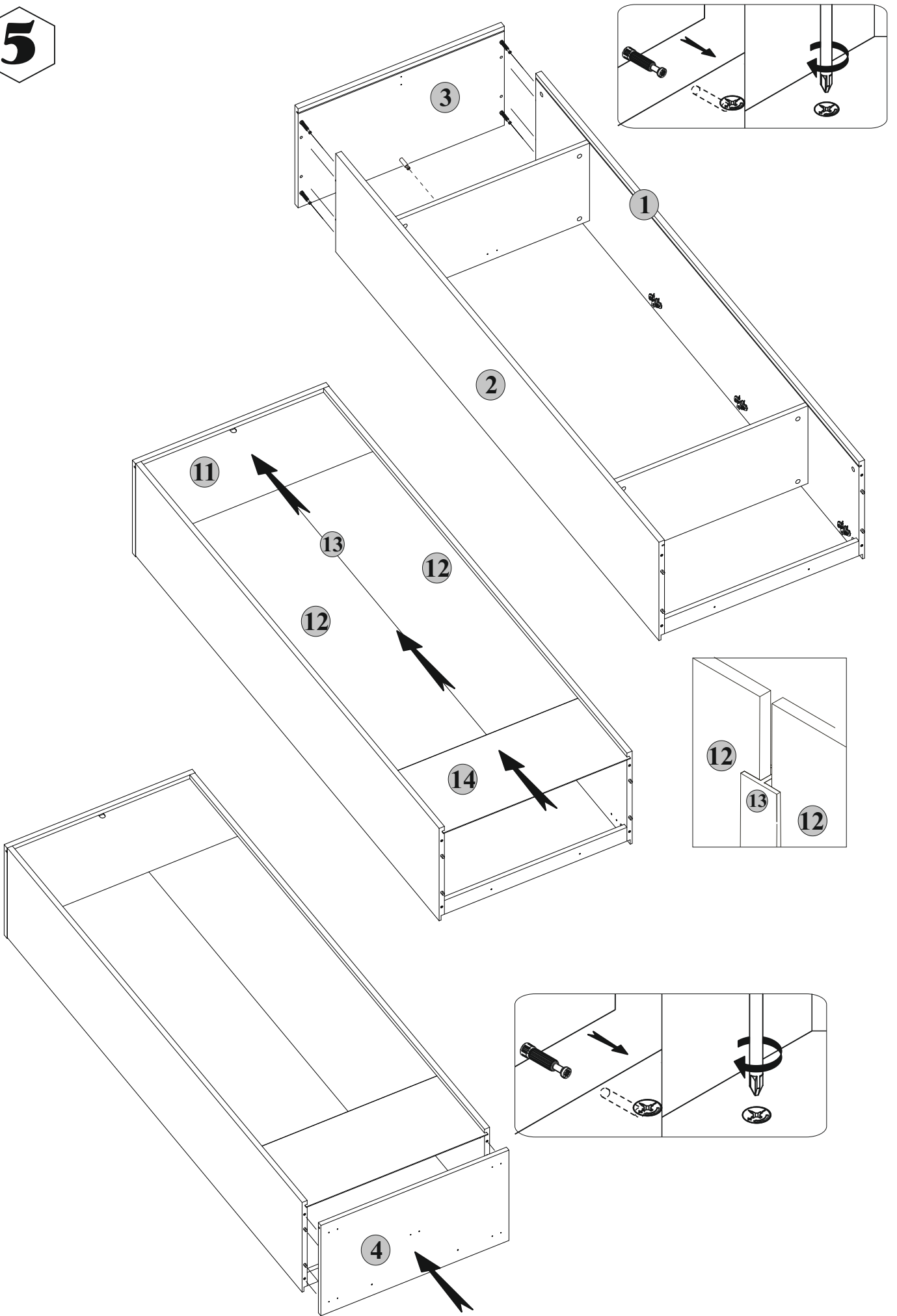

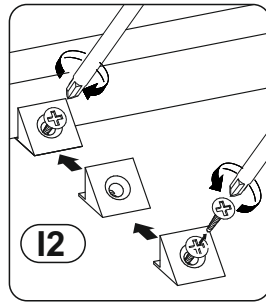
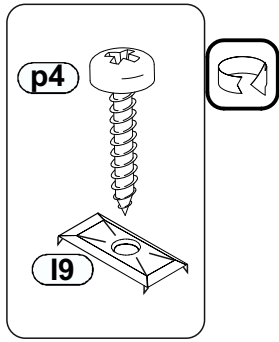

5



6



5x  k19	24x  I2
2x  φ4x30 mm p42	8x  3,5x20 p4
10x  φ3.5x3.5 mm p80	8x  I9

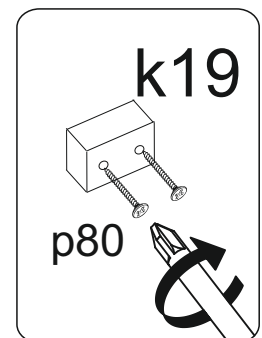
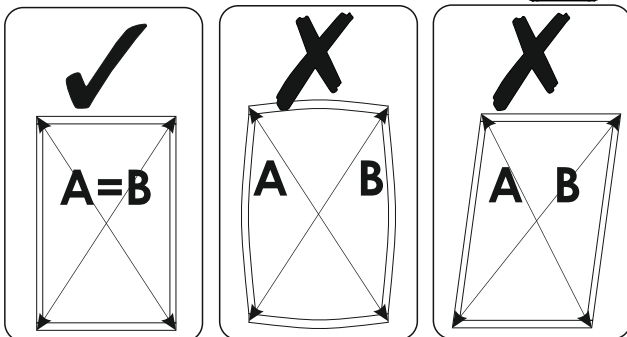
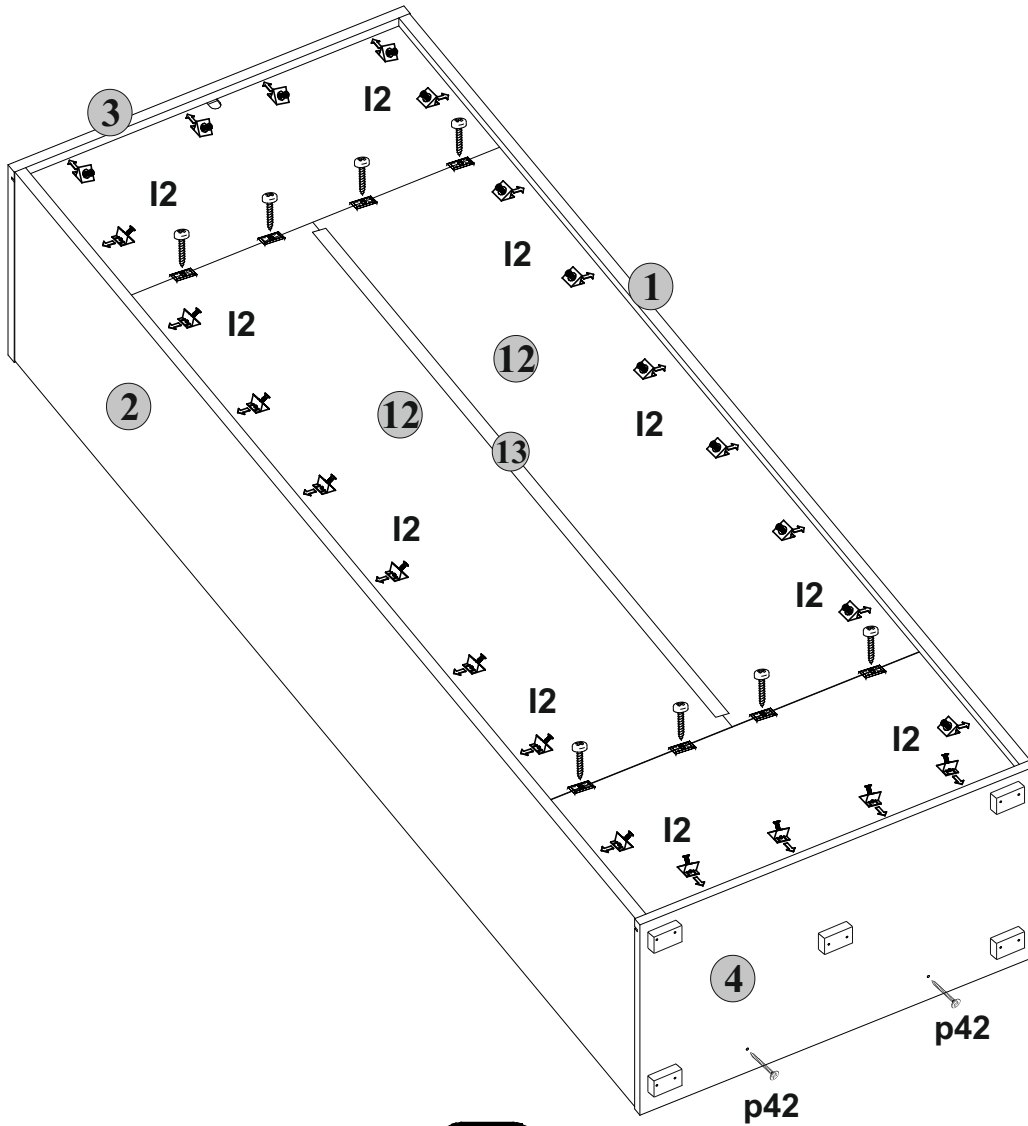

7

