

HOMESTORY

WOHNEN, WIE ES DIR GEFÄLLT.

POLSTER

BETRIEBSANLEITUNG



SO 4500

(Bitte aufbewahren) (Stand 10.06.2022)

setone
by Musterring

Nutzen Sie die Sicherheit einer großen Marke.



5 Jahre Garantie.

Auf set one Möbel ist Verlass.

Die Garantiebestimmungen, Gebrauchs- und Pflegeanweisungen sind im set one Möbel-Gütepass geregelt.



Service-Information

Sie erreichen uns per E-Mail oder über das Servicetelefon zu den üblichen Geschäftszeiten.



Individualität

Die set one Produktkennzeichnung belegt, dass Sie ein Unikat gekauft haben.



Pflege

Wir empfehlen Musterring Pflegeprodukte.

Lederpflege & Reinigung

Stoff-/ Mikrofaserpflege & Reinigung

Holzpflege und Sonderprodukte



Zu bestellen unter www.musterring-care.com oder unter der kostenlosen Beratungsnummer + 49 (0) 800 / 88 88 885.

Bei Fragen sprechen Sie uns bitte an; wir helfen Ihnen gerne weiter.

Zur Werterhaltung Ihrer Möbel

Unsere Pictogramme mit Erläuterungen

Aufbau

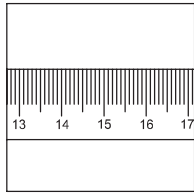

Maßangaben in den Preis- und Typenlisten beachten



Neu-/Umbauten sind vor der Lieferung abzuschließen

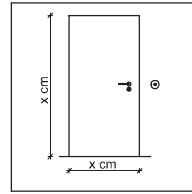

Stellflächen müssen eben und frei zugänglich sein

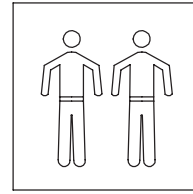

Lieferung und Montage nur durch Fachpersonal

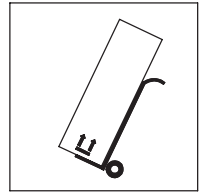

Verpackungsrichtlinien und Transporthinweise beachten

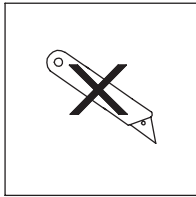

Nicht durch die Verpackung schneiden

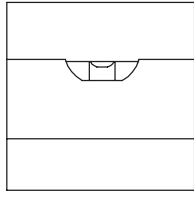

Genaueres Ausrichten mit der Wasserwaage erforderlich

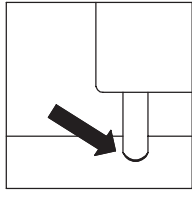

Möbelfüße/-gleiter sind den Fußböden anzupassen

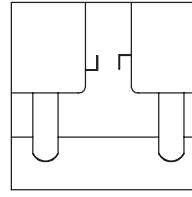

Elementverbindungen nach Herstellervorgaben

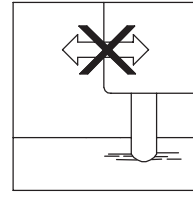

Montagezustand nicht ohne Demontage verändern

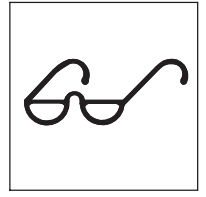

Abnahme durch Sicht- und Funktionsprüfung

Betrieb

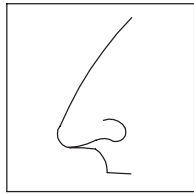

Neumöbelgeruch ist material- und warentypisch

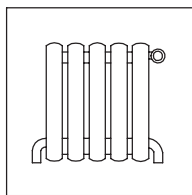

Mindestabstand zu Heizquellen beachten

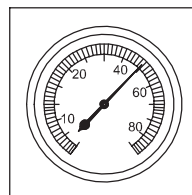

Empfohlenes Raumklima Ø 45-55% Luftfeuchte

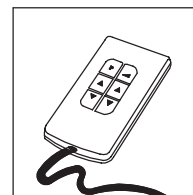

Betriebsanleitung beachten

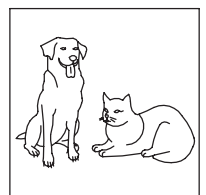

Haustiere schaden Bezügen bzw. Oberflächen

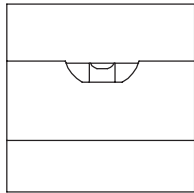

Genaueres Ausrichten mit der Wasserwaage erforderlich

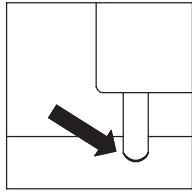

Möbelfüße/-gleiter sind den Fußböden anzupassen

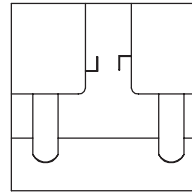

Elementverbindungen nach Herstellervorgaben

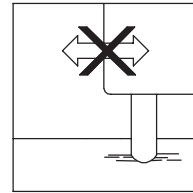

Montagezustand nicht ohne Demontage verändern

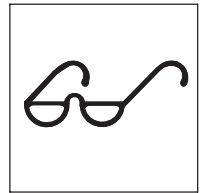

Abnahme durch Sicht- und Funktionsprüfung

Wartung

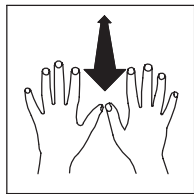

Polsterbezüge regelmäßig aufklöpfen

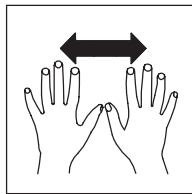

Polsterbezüge regelmäßig glätten

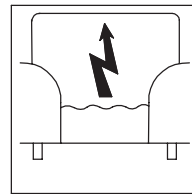

Statische Aufladung der Bezüge möglich

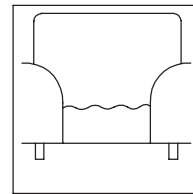

Legerer Polsteraufbau neigt zur Wellenbildung

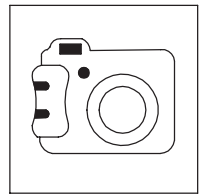

Im Schadenfall Foto: Gesamt-, Detailansicht

Betriebsanleitung

(bitte aufbewahren)

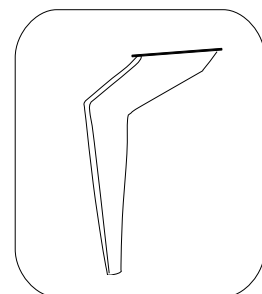
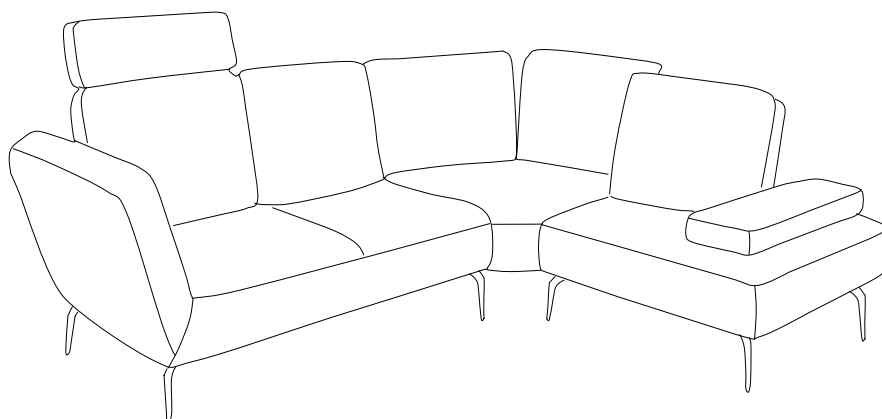
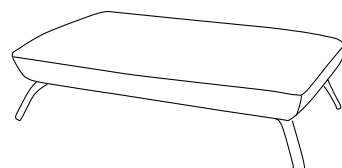
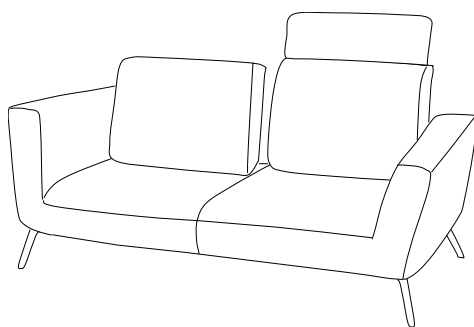
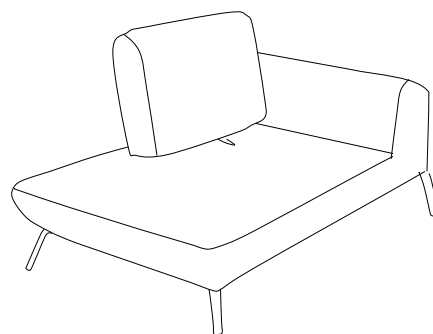
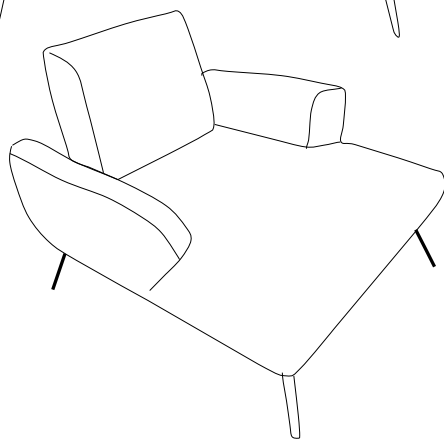
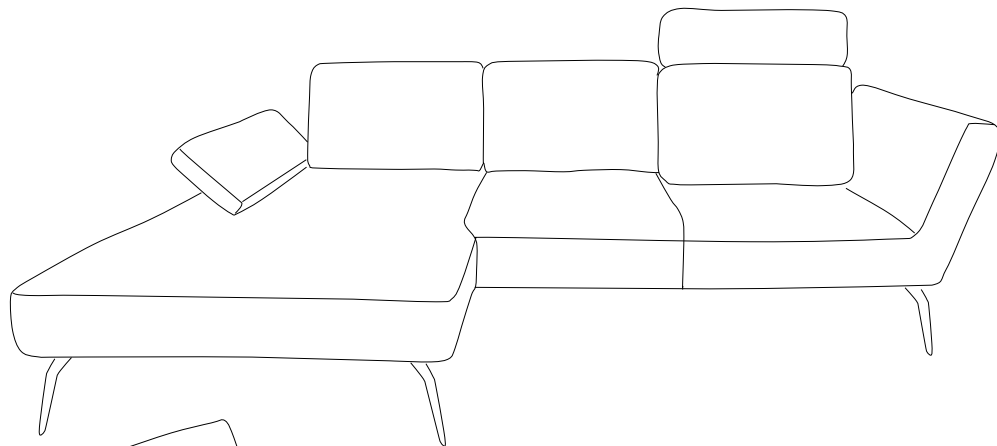
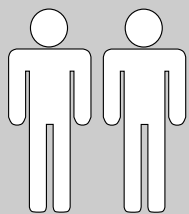

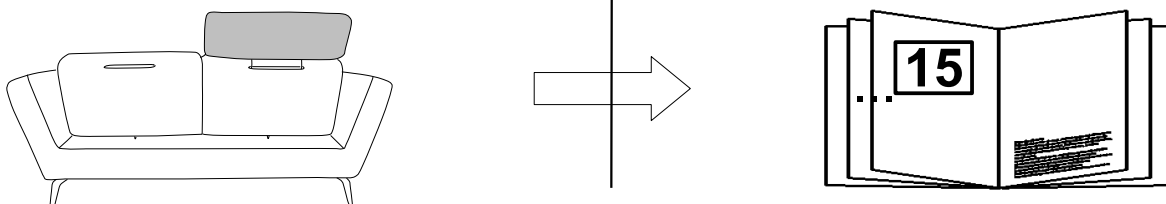
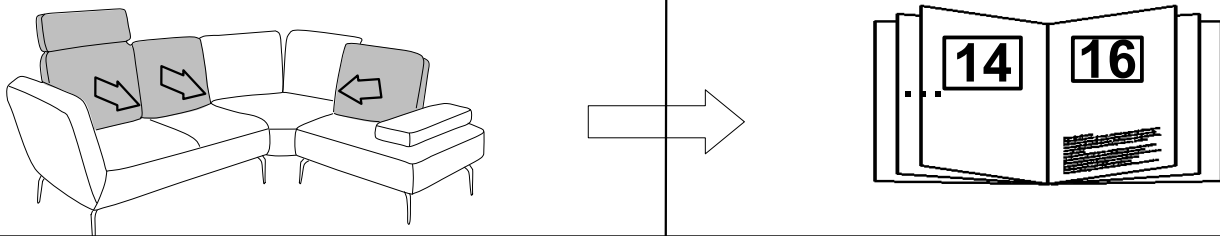
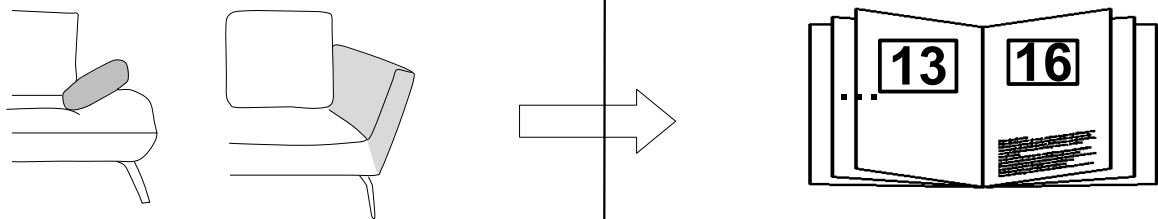
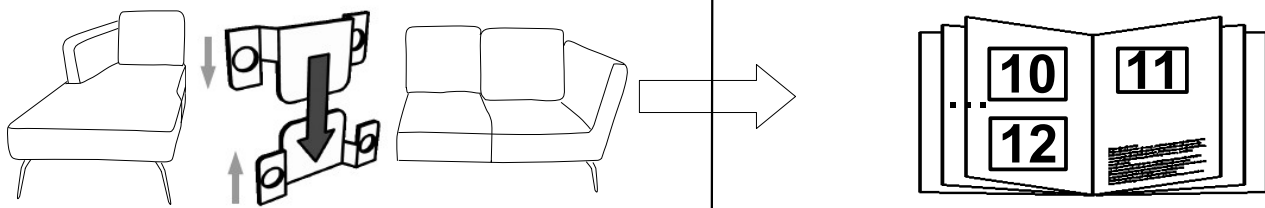
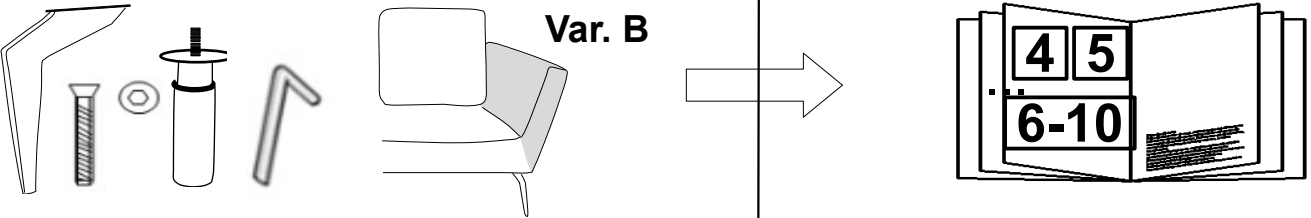
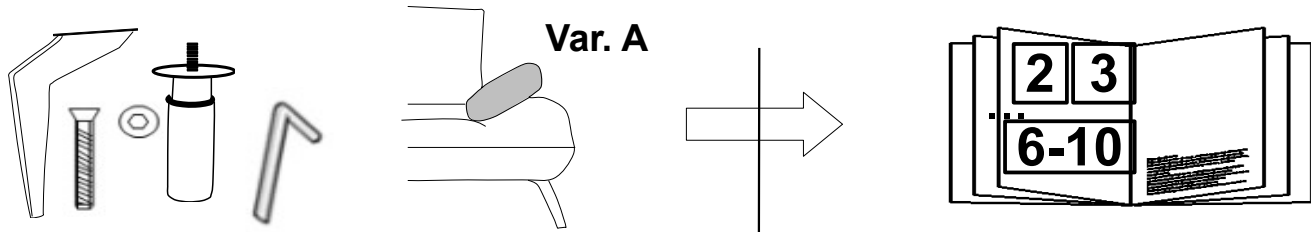







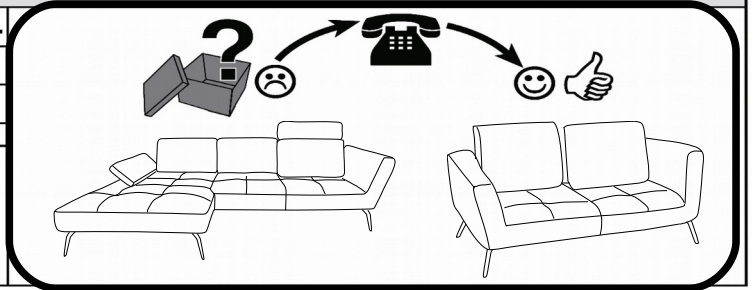
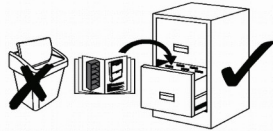

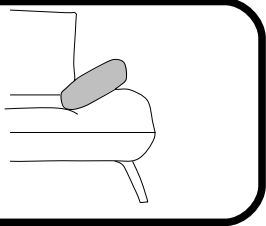

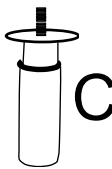

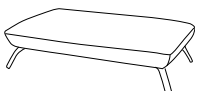
SO 4500

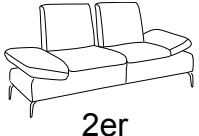
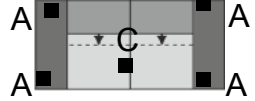
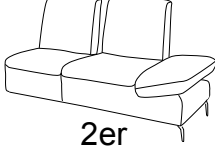
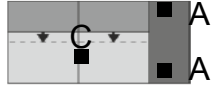
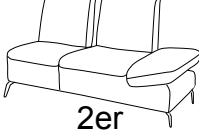
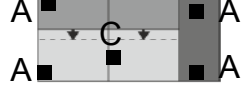
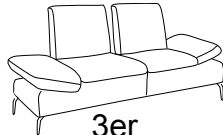
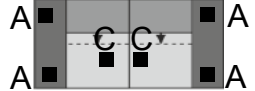
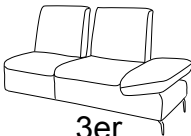
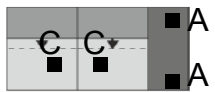
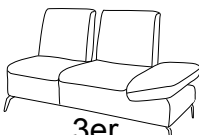
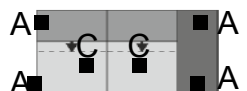
Service · Dienstverlening · Serwis · Servis · Сервисная служба · Serviciu · Services · Servizio · Servisný list · Szolgáltatás · Servisní list

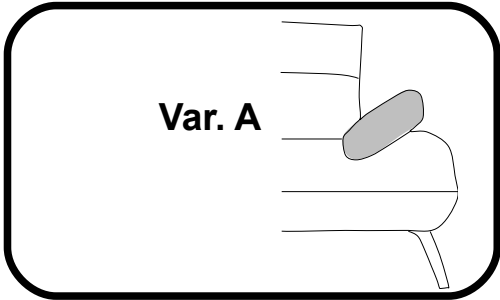
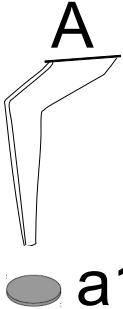
Name · Naam · Nazwa · İsim · Название · Nume · Nome ·
 Názov · Názov · Název · Neve
SO 4500
 Тур · Туре · Тір · Тип · Тіро · Тірус

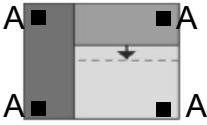
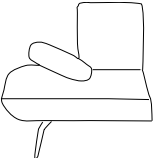

✓	Var. A		 A a1	 B M6x25	 C	 D 4L
			4 x A 4 x a1	4x4B	/	
	 2er		4 x A 4 x a1	4x4B	1C	
	 2er		2 x A 2 x a1	2x4B	1C	
	 2er		4 x A 4 x a1	4x4B	1C	1D
	 3er		4 x A 4 x a1	4x4B	2C	
	 3er		2 x A 2 x a1	2x4B	2C	
	 3er		4 x A 4 x a1	4x4B	2C	

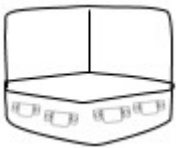
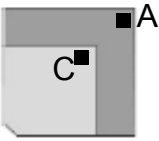
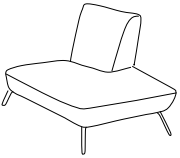
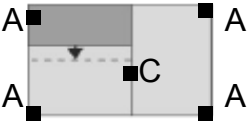
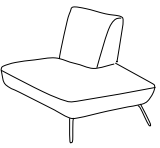
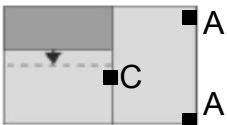
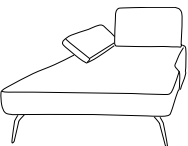
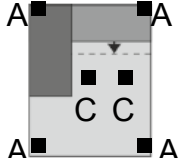
✓			 M6x25		 4L	
			4 x A 4 x a1	4x4B	/	
			2 x A 2 x a1	2x4B	/	
			1 x A 1 x a1	1x4B	1C	
			4 x A 4 x a1	4x4B	1C	1D
			2 x A 2 x a1	2x4B	1C	
			4 x A 4 x a1	4x4B	2C	

SO 4500

Service · Dienstverlening · Serwis · Servis · Сервисная служба · Serviciu · Services · Servizio · Servisný list · Szolgáltatás · Servisní list

Name · Naam · Nazwa · İsim · Название · Nume · Nome ·
Názov · Názov · Název · Neve





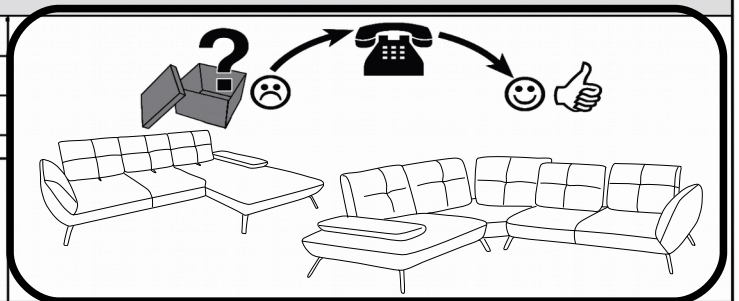
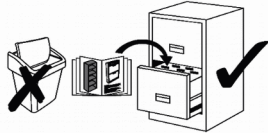





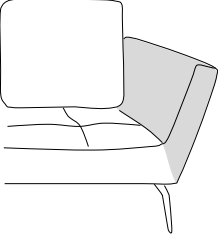
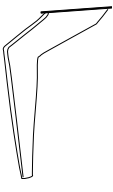

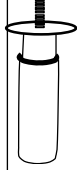
SO 4500

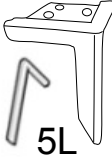
Тип · Type · Tip · Тип · Tipo · Típus

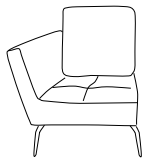
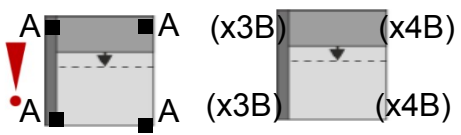
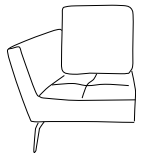
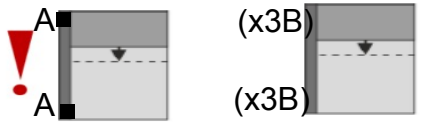
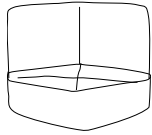
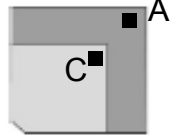

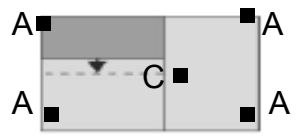
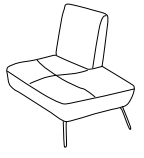
✓	Var. B		A a1	B M6x25	C	D 4L
			4 x A 4 x a1	4x4B	/	
	 2er		4 x A 4 x a1	4x3B	1C	
	 2er		2 x A 2 x a1	2x3B	1C	
	 2er		4 x A 4 x a1	2x3B + 2x4B	1C	1D
	 3er		4 x A 4 x a1	4x3B	2C	
	 3er		2 x A 2 x a1	2x3B	2C	
	 3er		4 x A 4 x a1	2x3B + 2x4B	2C	

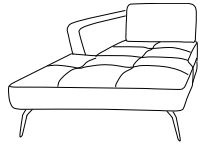
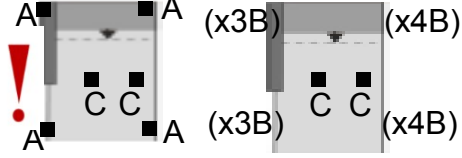
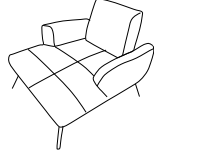
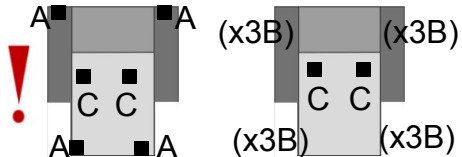
SO 4500

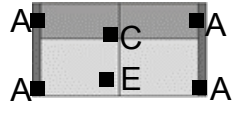
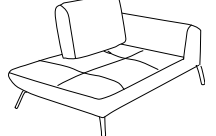
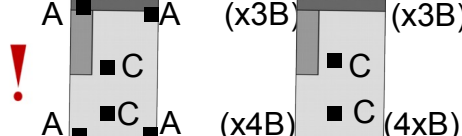
✓	<div style="border: 2px solid black; border-radius: 15px; padding: 10px; display: flex; align-items: center; justify-content: center;"> <div style="margin-right: 20px;">Var. B</div>  </div>		A   a1	B  M6x25	C 	D  4L	E  5L  M8x30  e1
			4xA 4xa1	2x3B + 2x4B	/		/
			2xA 2xa1	2x3B	/		/
			1xA 1xa1	1x4B	1C		/
			4xA 4xa1	4x4B	1C		/
			2xA 2xa1	2x4B	1C	1D	/
			4xA 4xa1	2x3B + 2x4B	2C		/
			4xA 4xa1	4x3B	2C		/
	 MEGASOFA		4xA 4xa1	4x3B	1C		1xE 1xe1
			4xA 4xa1	2x3B + 2x4B	2C		/

Die Piktogramme sind schematisch und können von der Wirklichkeit abweichen !

SO 4500

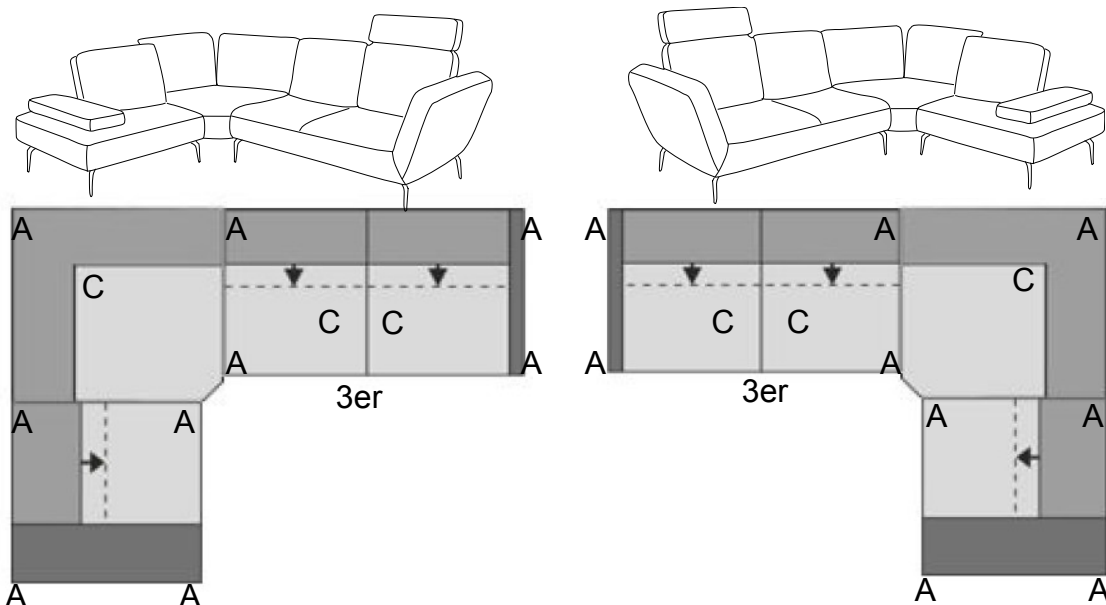
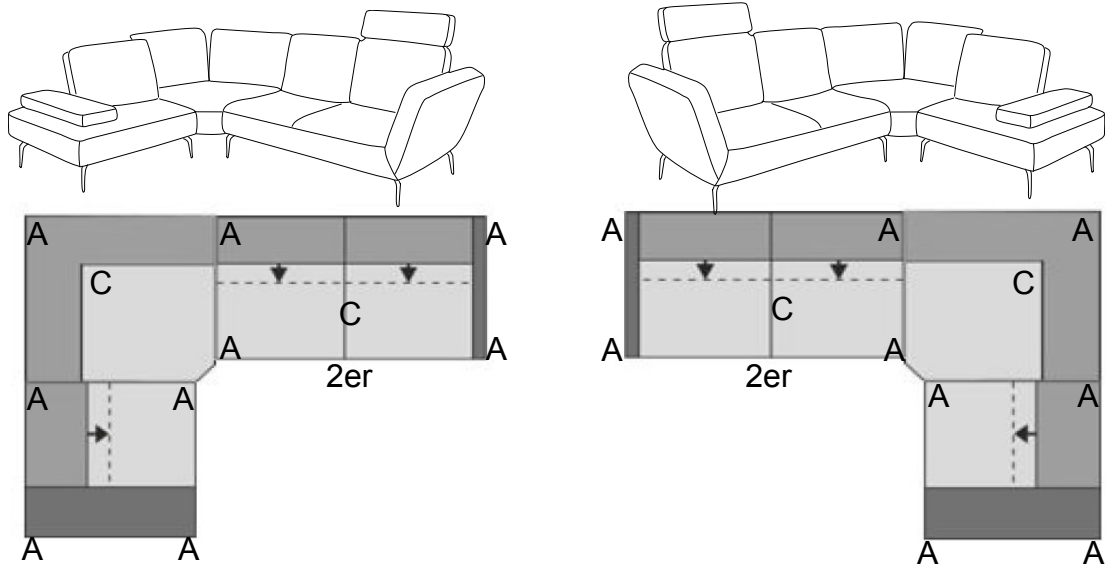
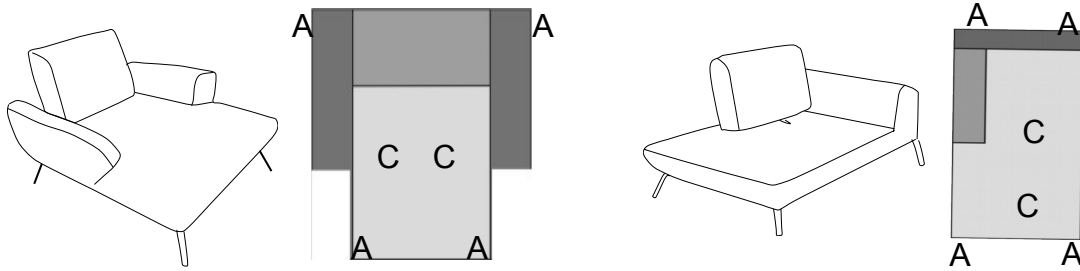
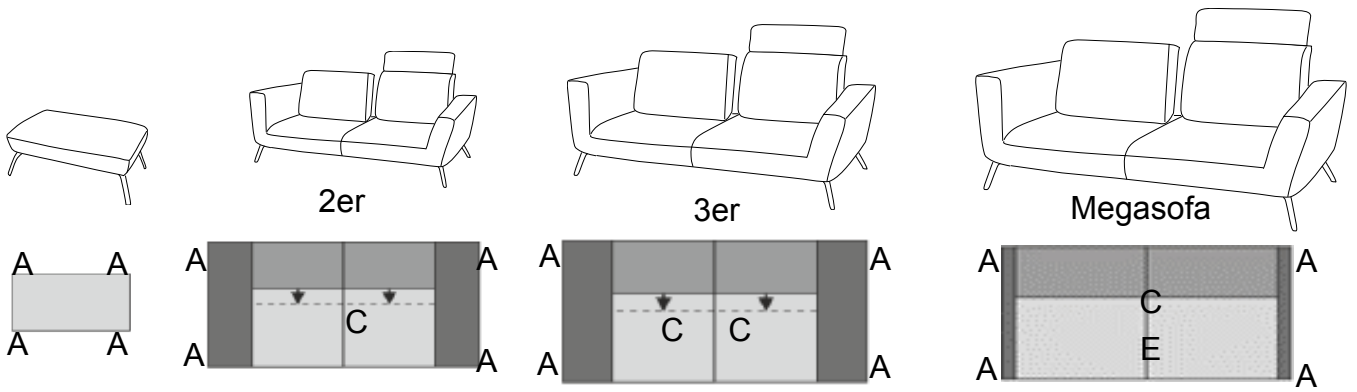

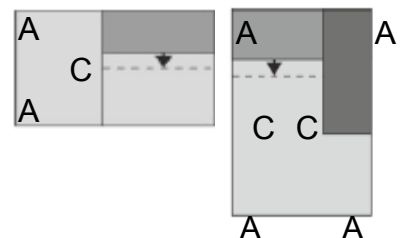
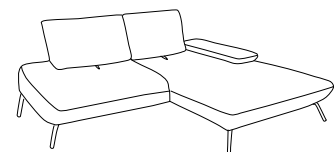
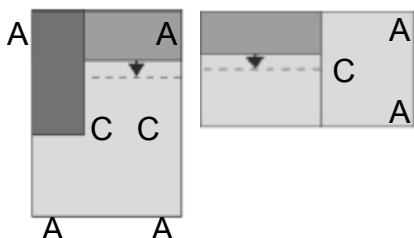
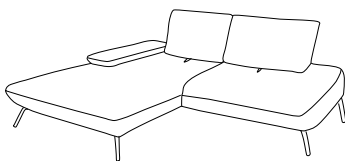
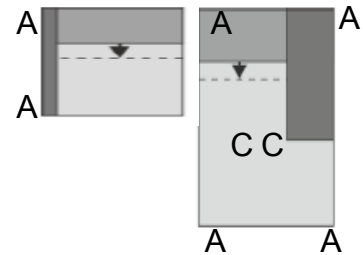
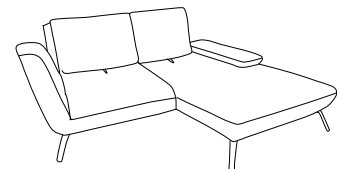
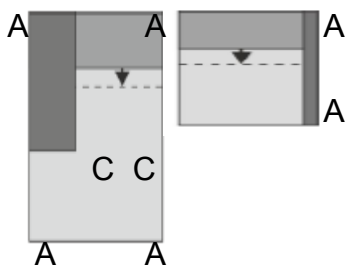
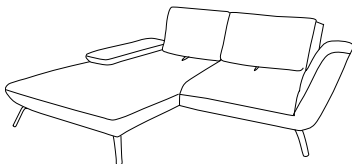
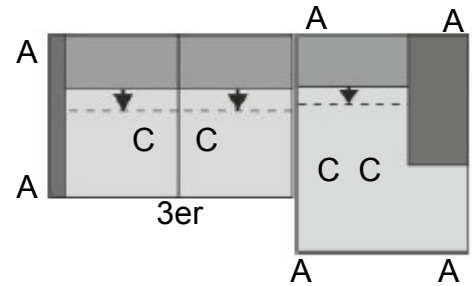
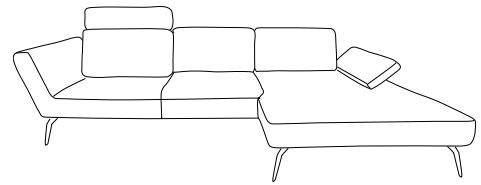
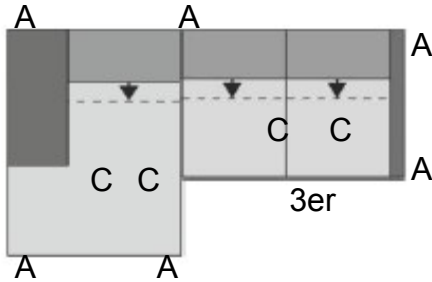
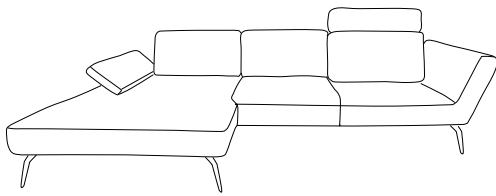
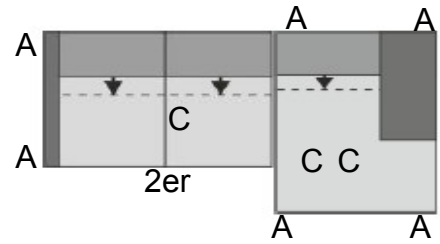
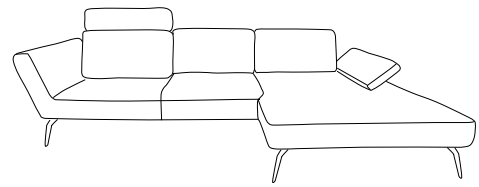
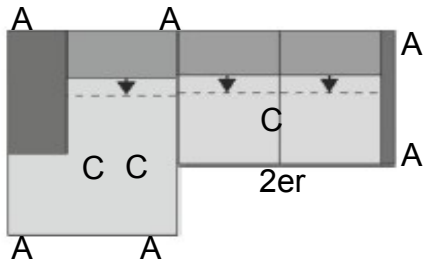
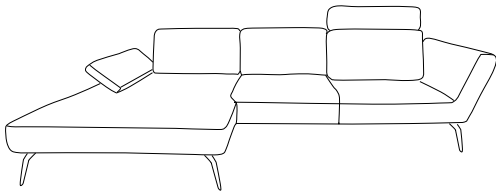

1

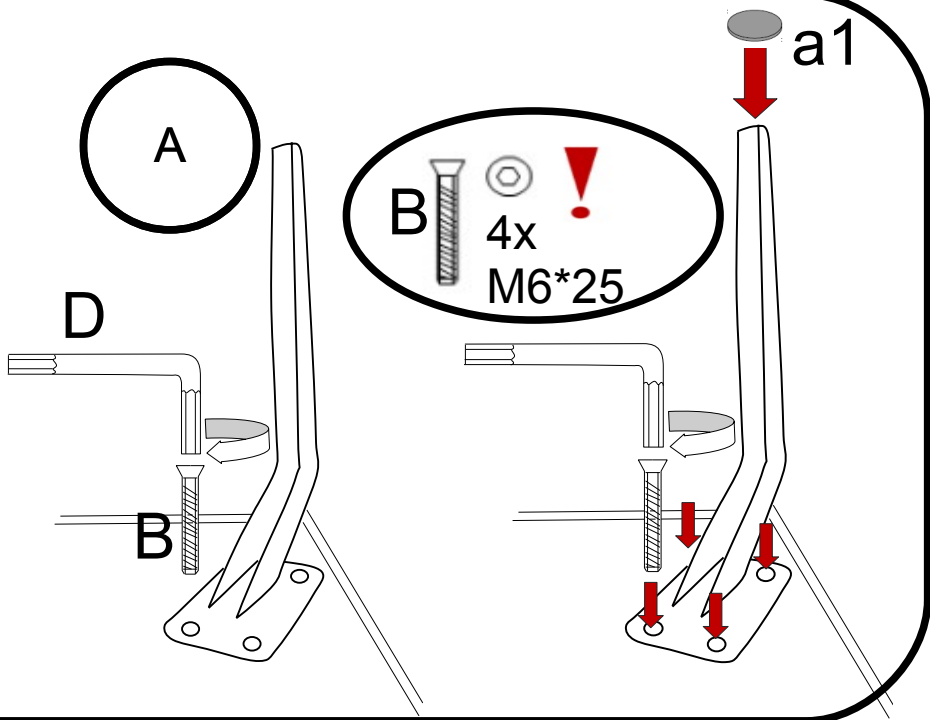
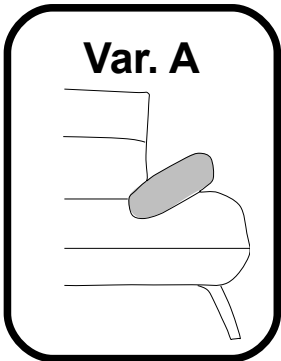
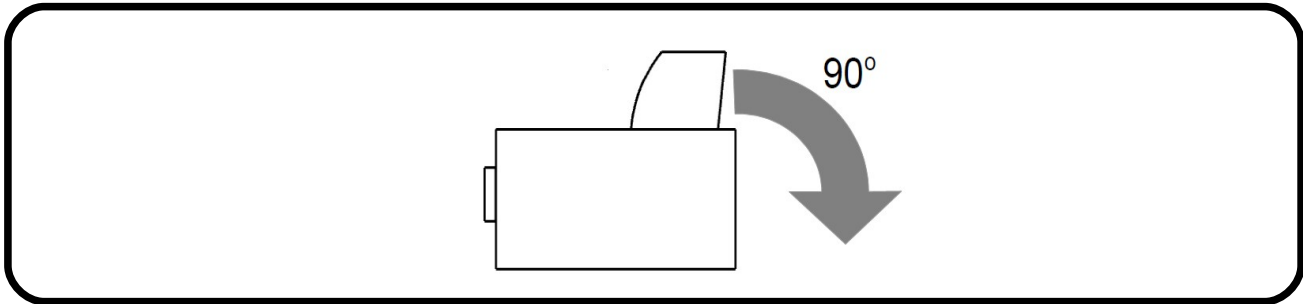

2

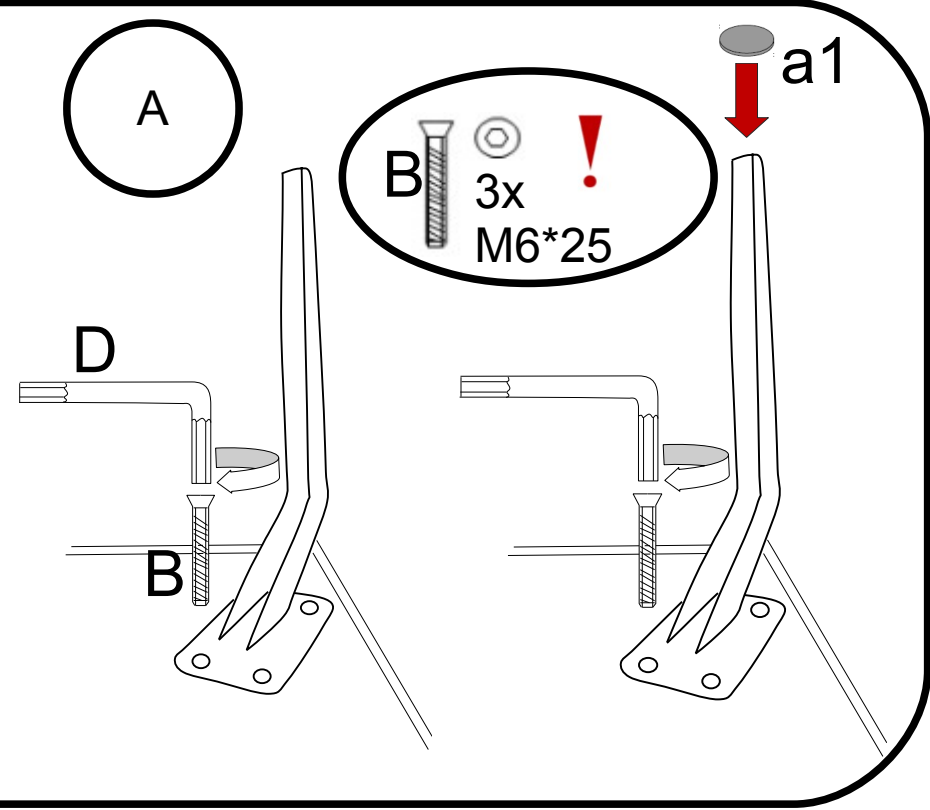
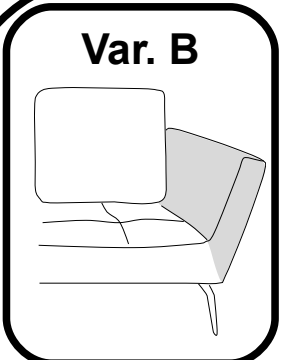

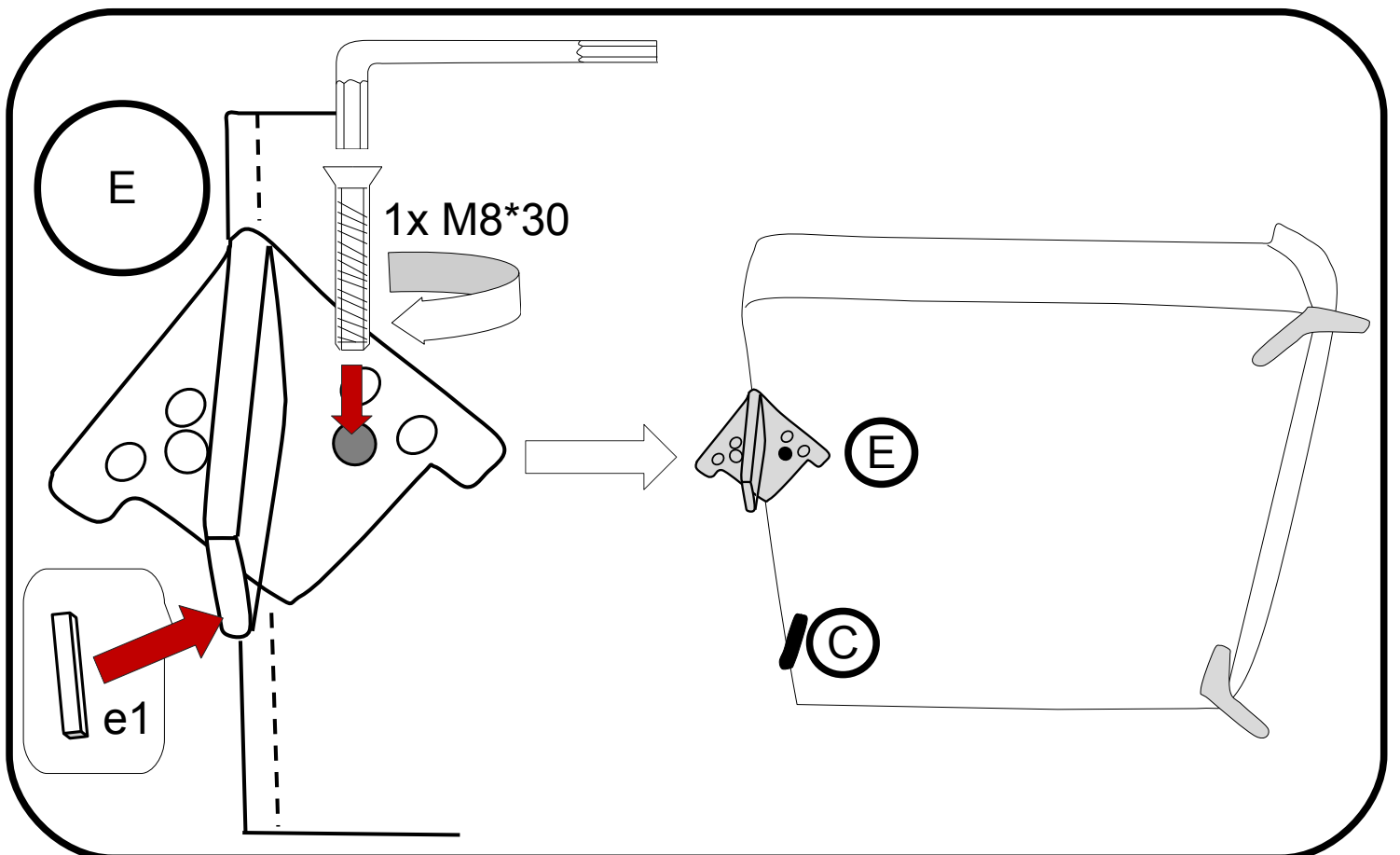
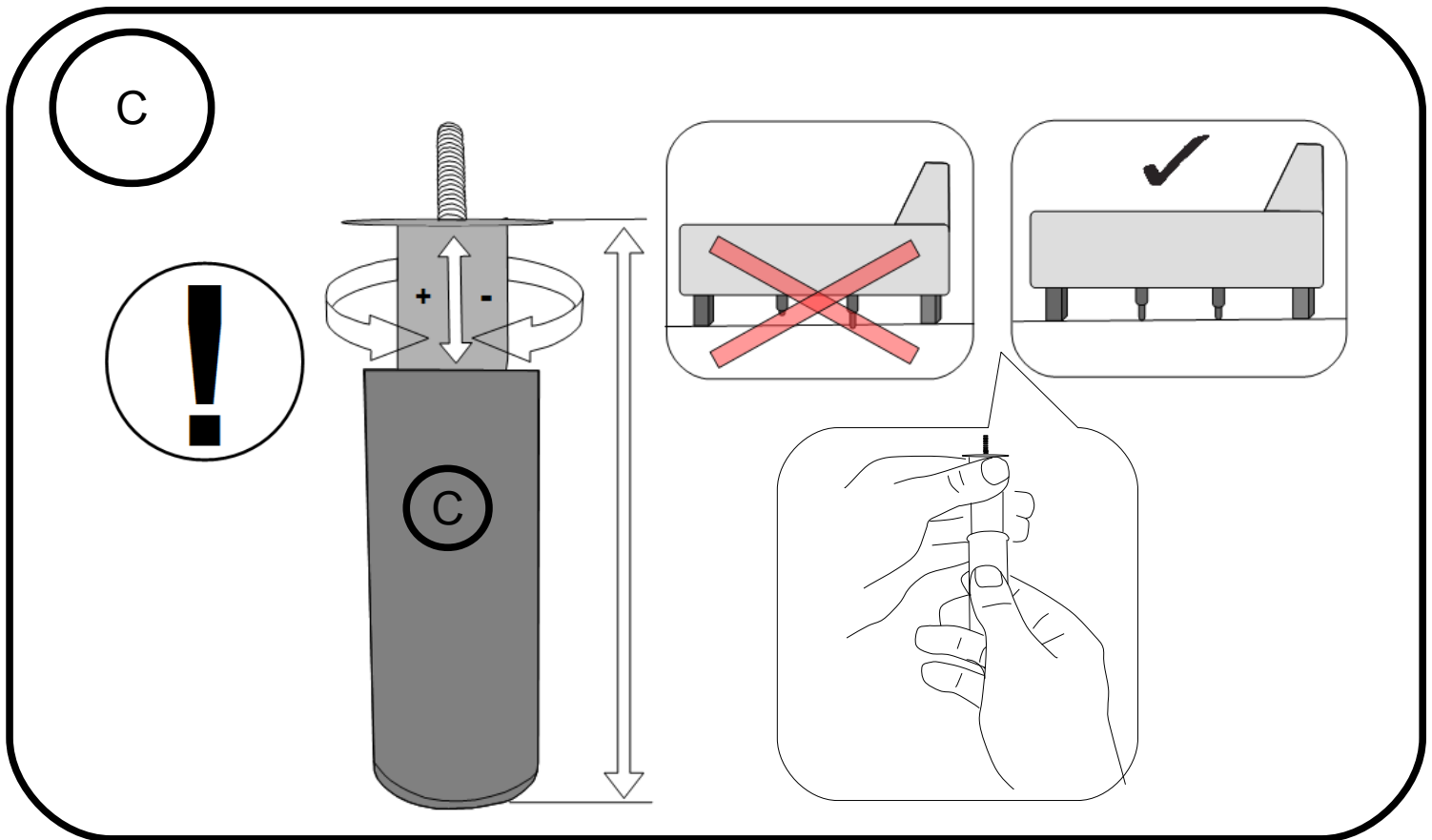

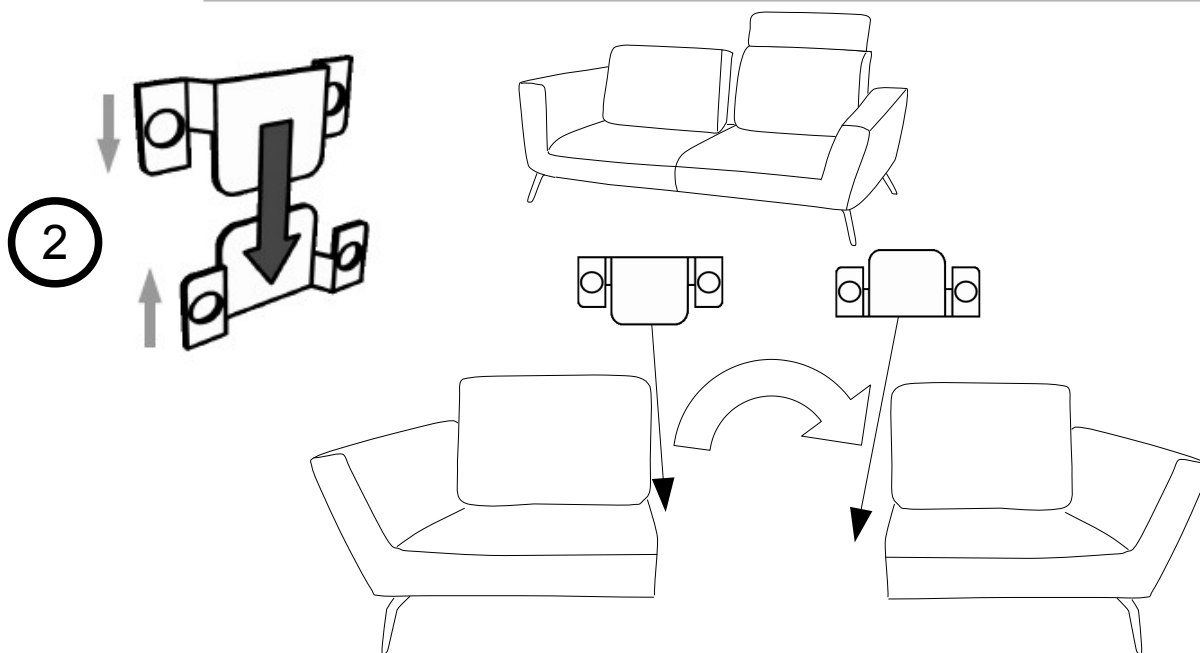
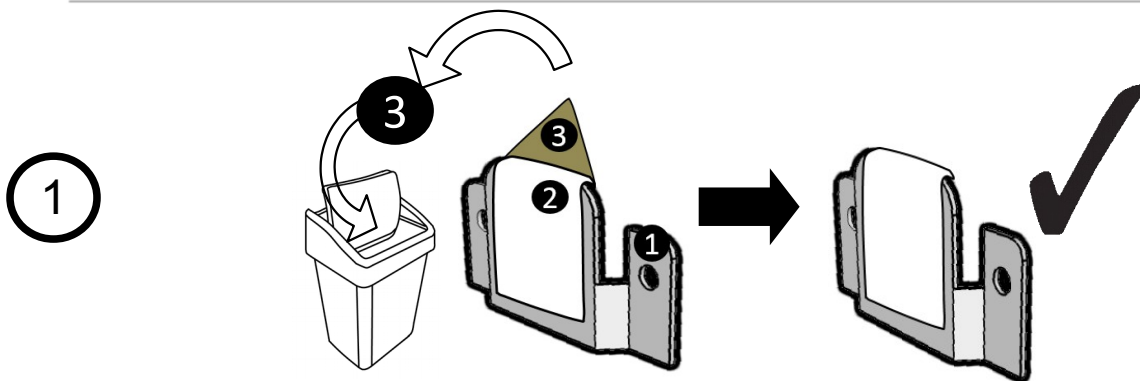
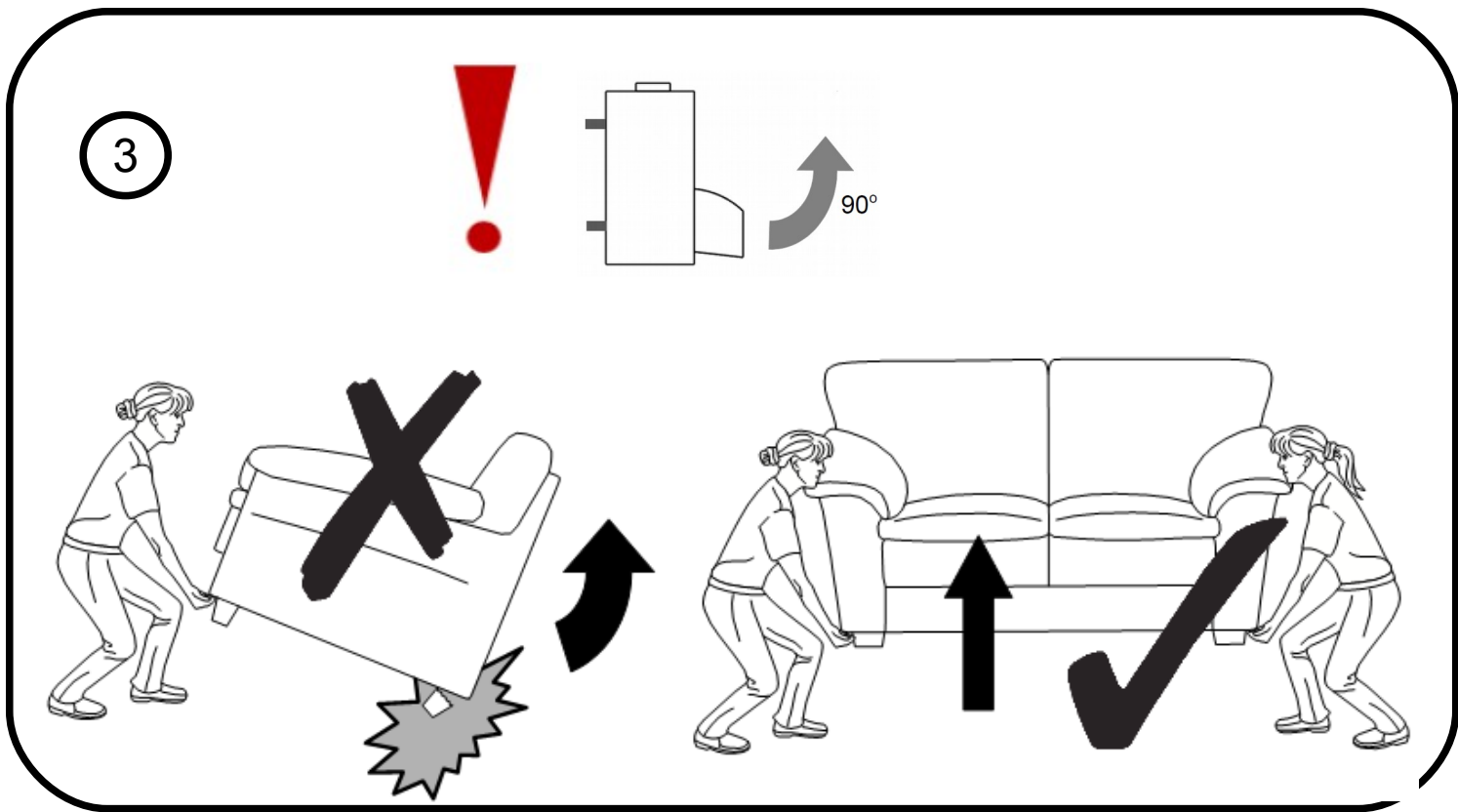

1

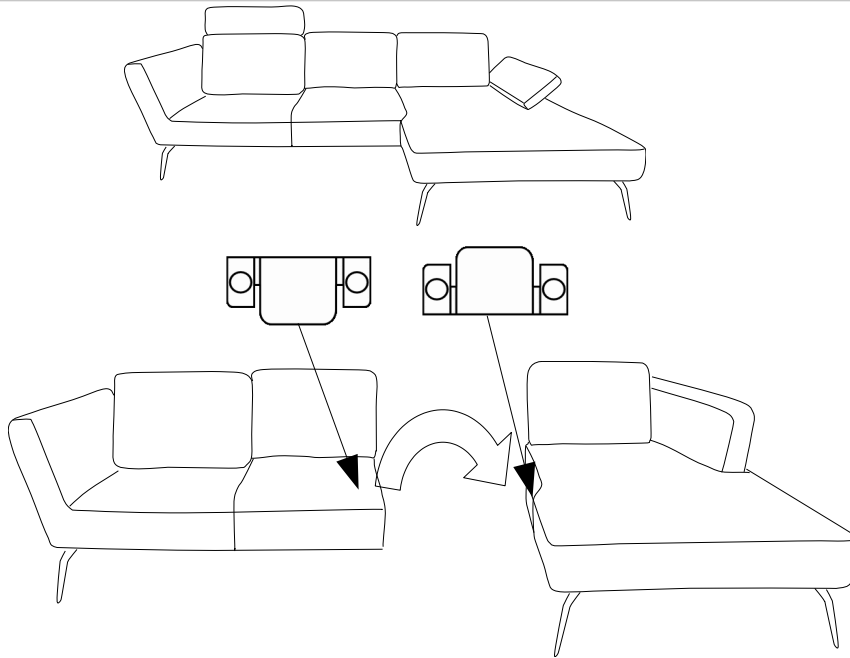
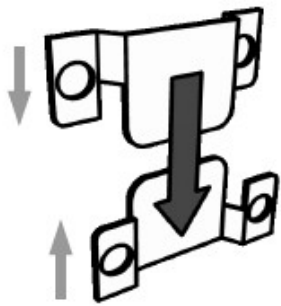
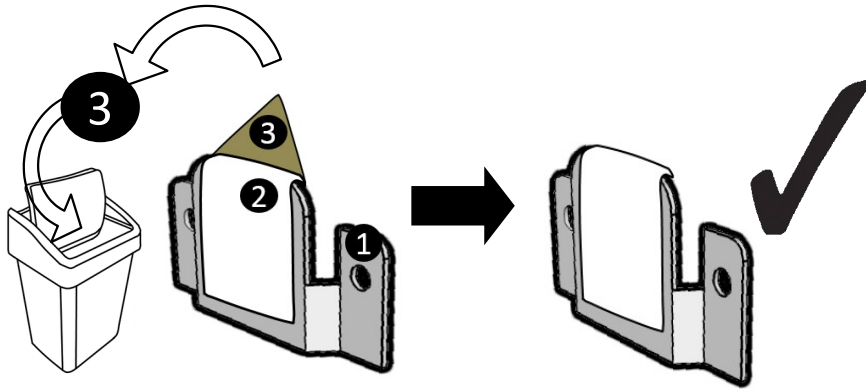

2

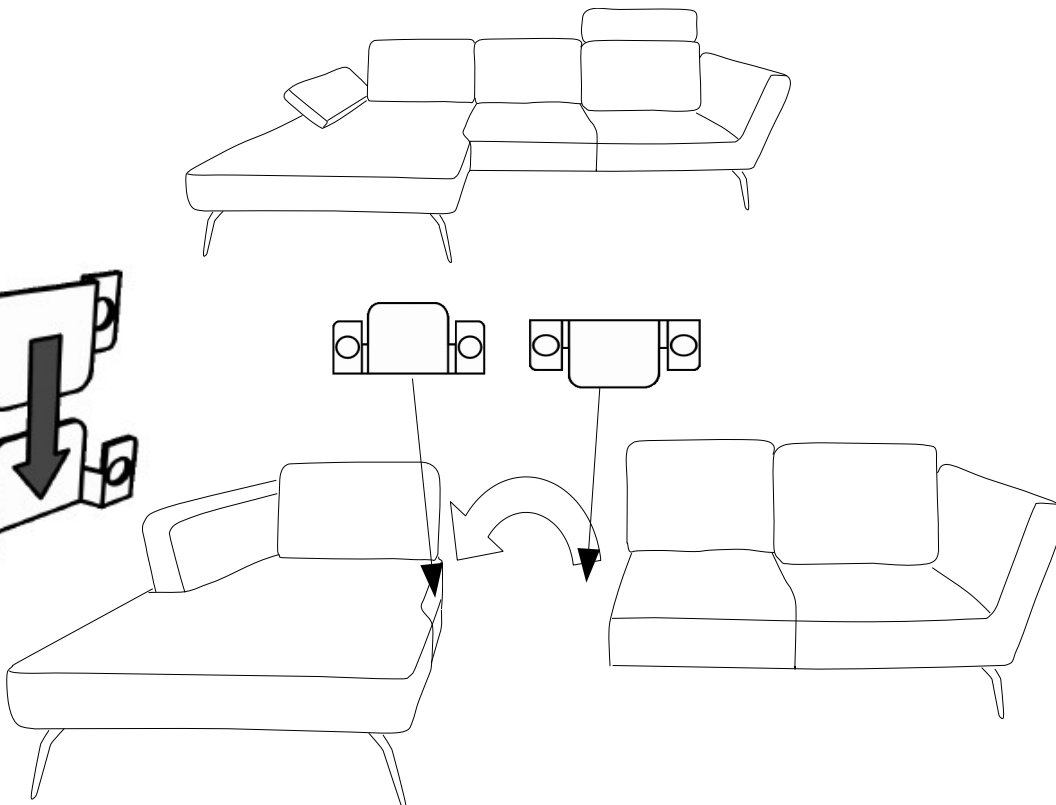
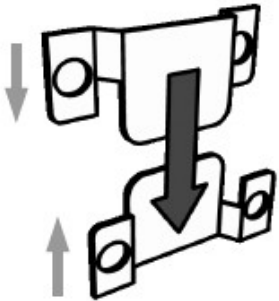

1

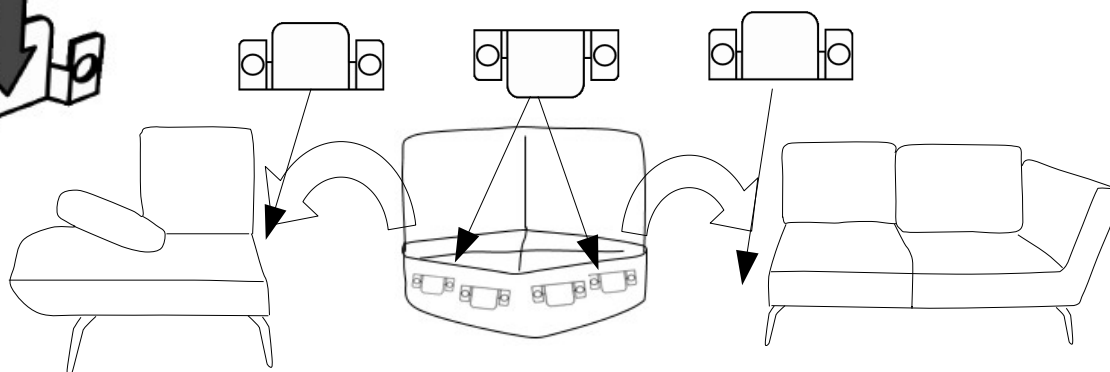
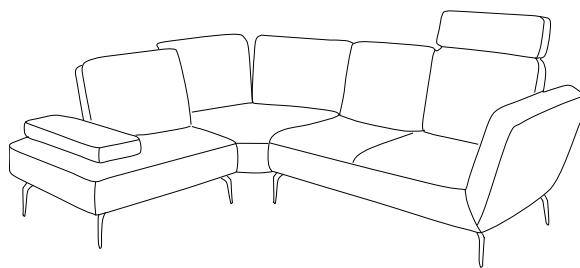
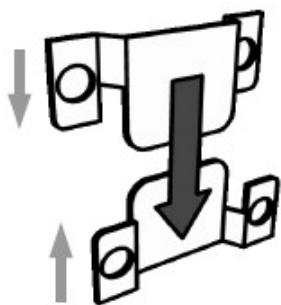
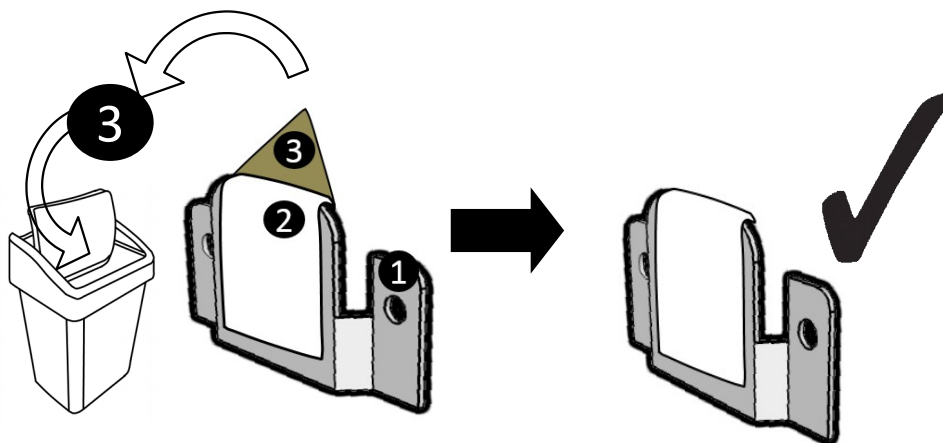

2

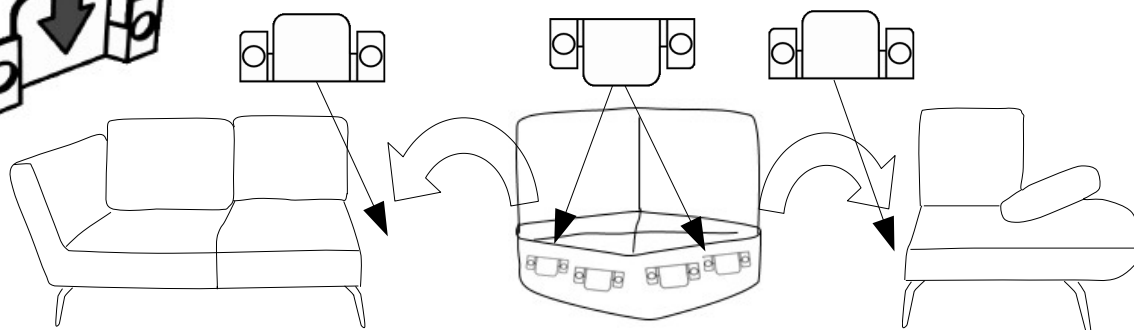
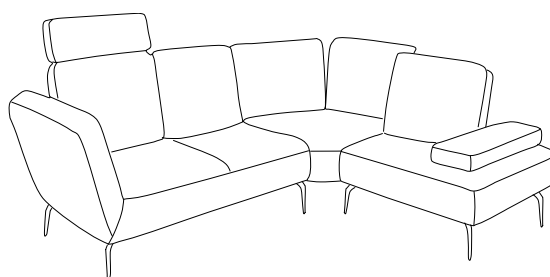
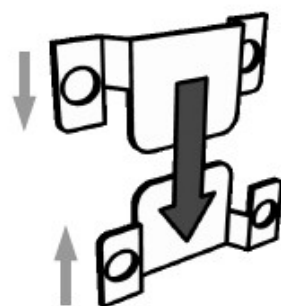

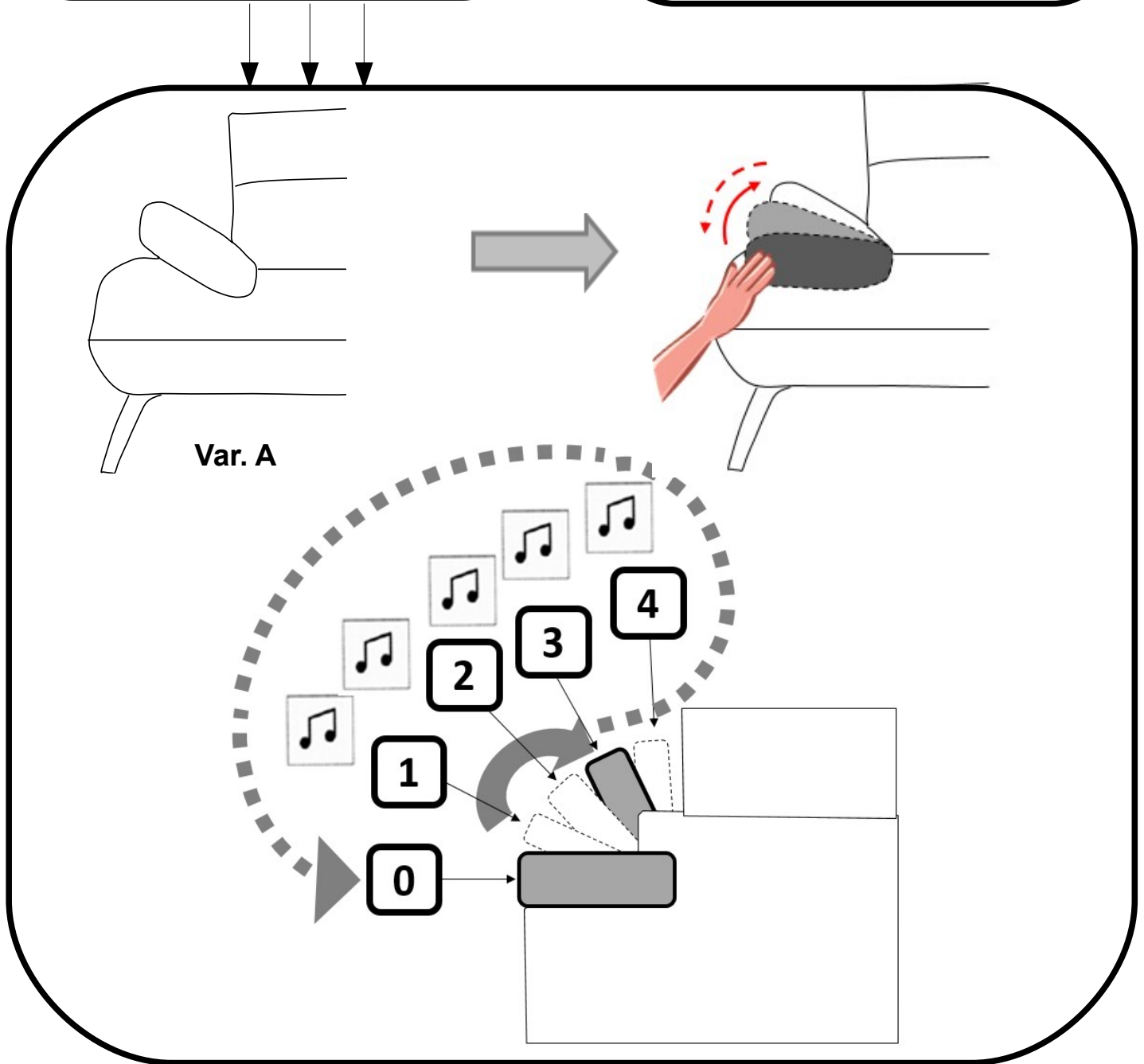
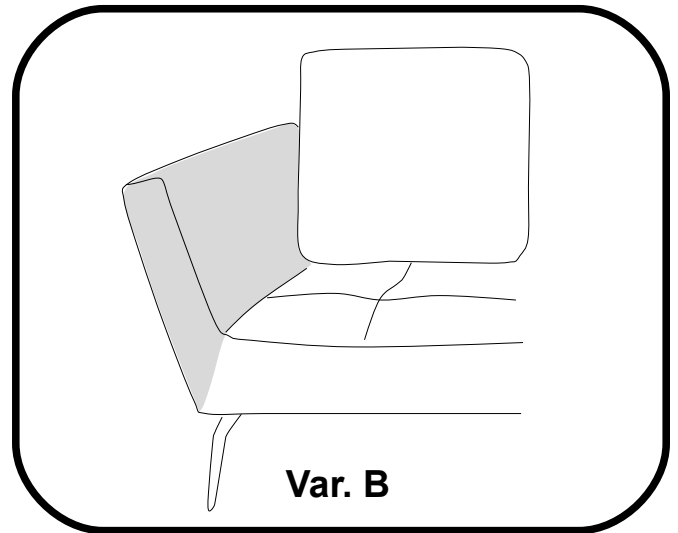
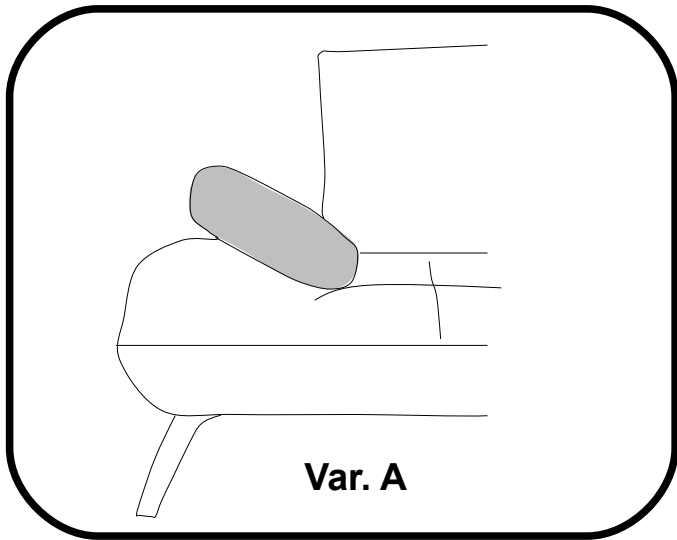

SO 4500

