

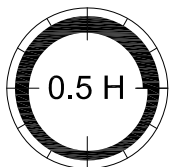

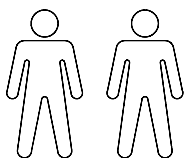

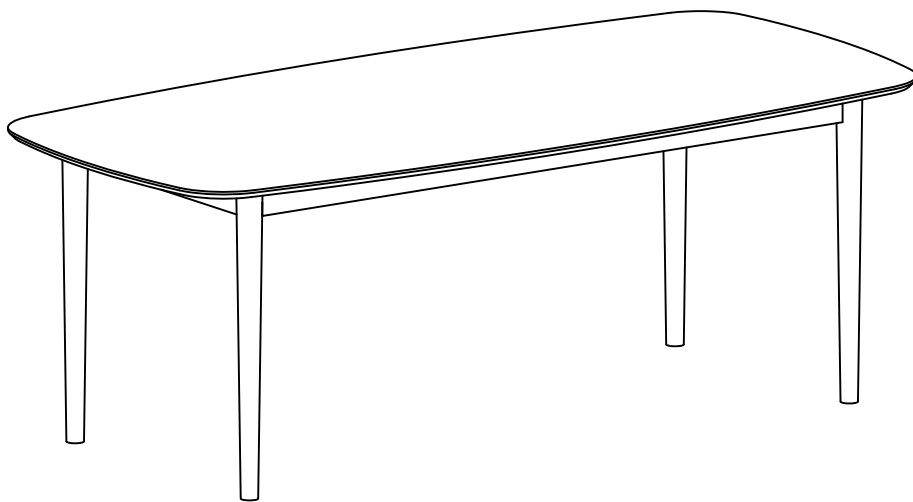

ASTON

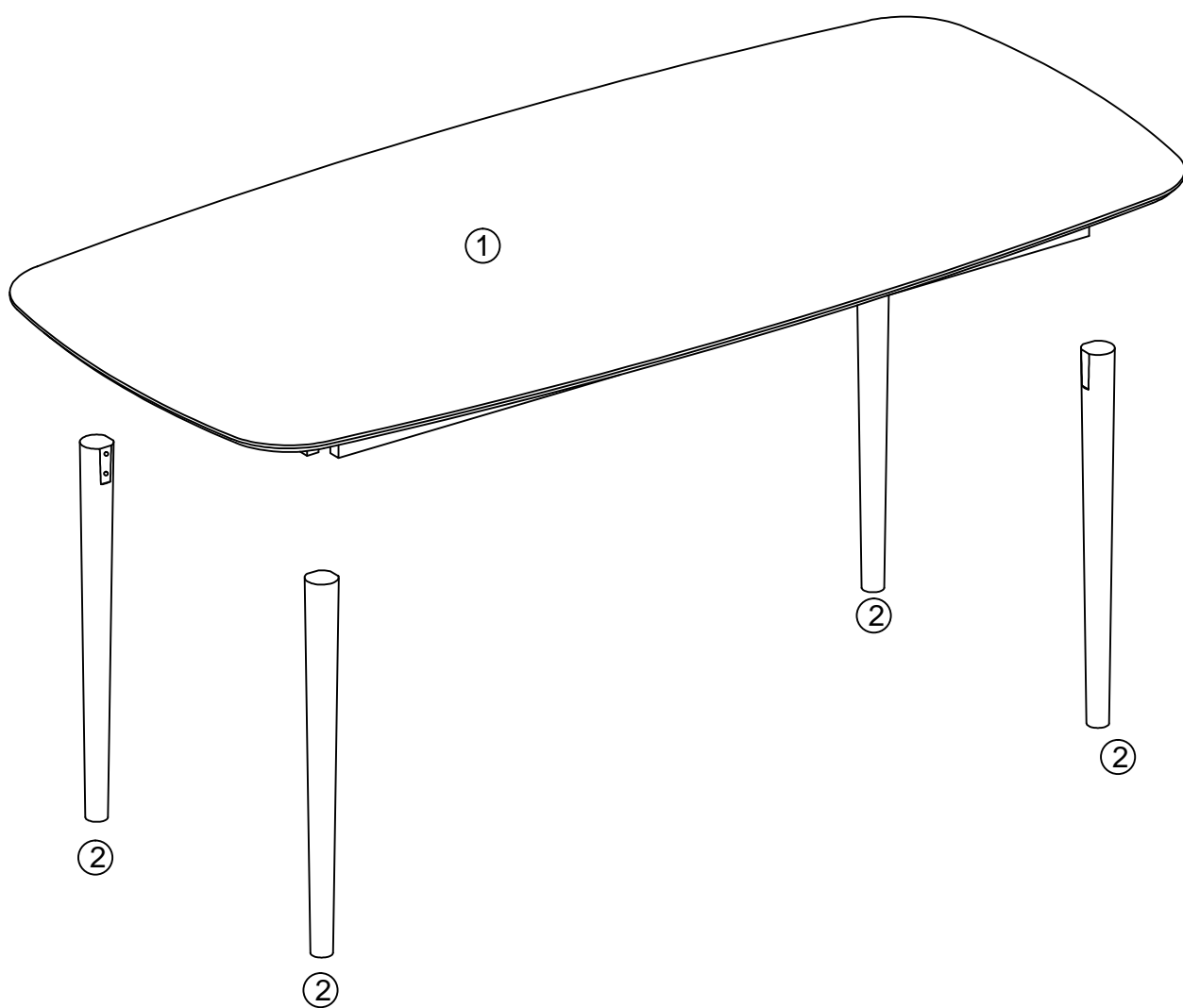





			✓
①	1	2100x1000x89	
②	4	731x ϕ 60/ ϕ 40	



<p>A x8</p>  <p>M8x80</p>	<p>B x8</p>  <p>M8</p>	<p>C x8</p>  <p>M8/φ19mm</p>	<p>D x1</p>  <p>5mm</p>	<p>E x4</p>  <p>φ35mm</p>
--	---	---	--	--

1

A x8  M8x80	B x8  M8	C x8  M8/φ19mm	D x1  5mm	E x4  φ35mm
--	---	---	--	--

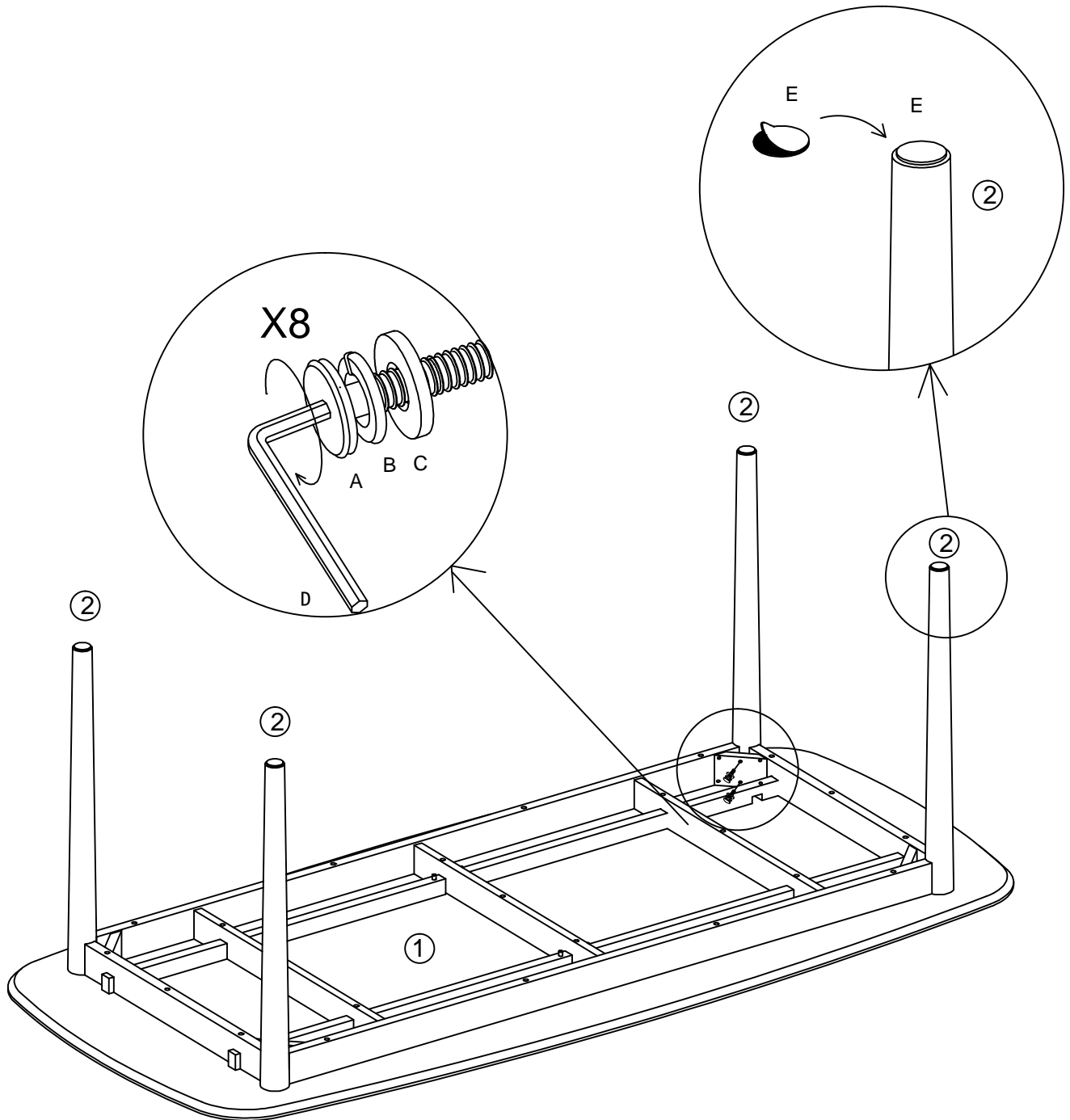

2

