

# Tivoli

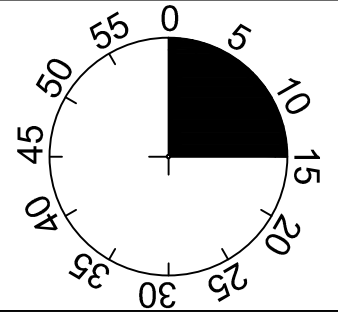

1

2

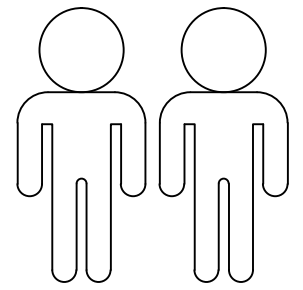
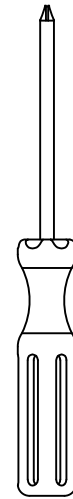
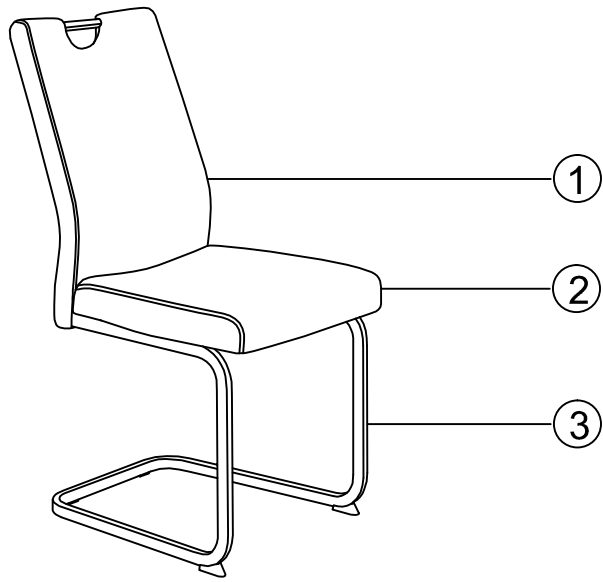

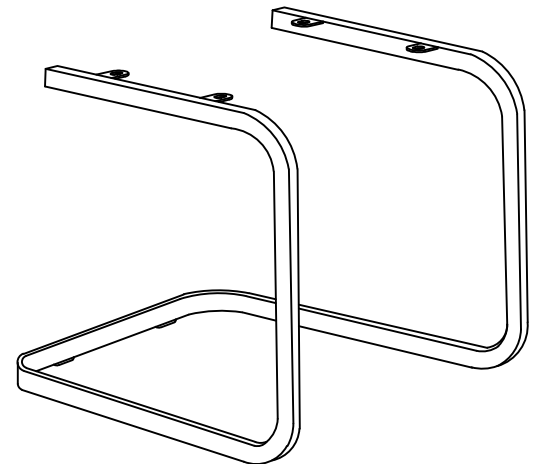
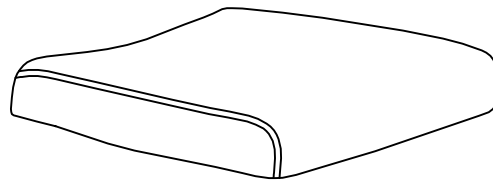

3

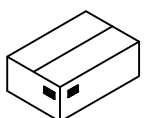

1	1x
2	1x
3	1x

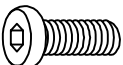

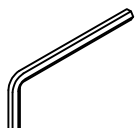
1/1

A	M6X20	B	M6X12	C	Ø18xØ6x1.5	D	4MM	E	M4x25	F	
	4x		4x		4x		1x		4x		2x

**I.**

**1**

E M4x25 4x

F 2x

100%

**2**

B M6x12 4x

D 4MM 1x

75%

**3**

A M6x20 4x

C Ø18xØ6x1.5 4x

D 4MM 1x

75%

**4**

D 4MM 1x

100%

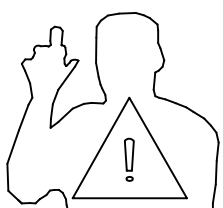

**LE TRI  
+ FACILE**



Séparez les éléments avant de trier