

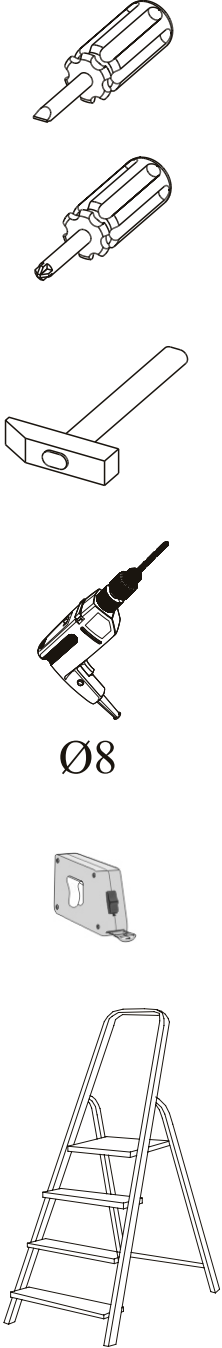

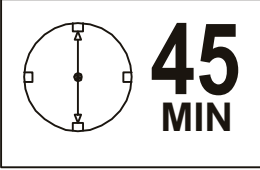

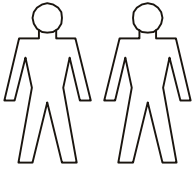

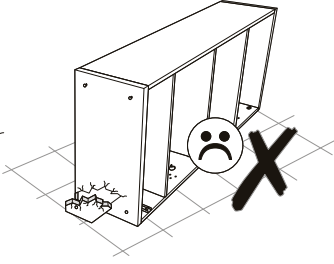

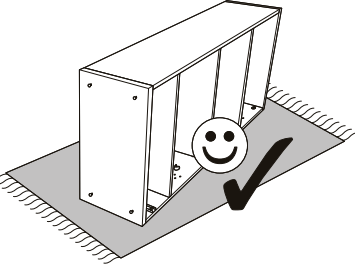
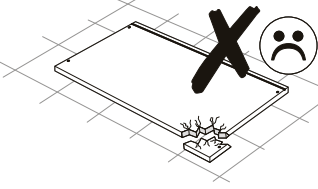
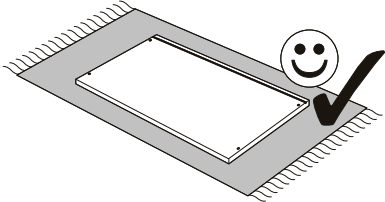
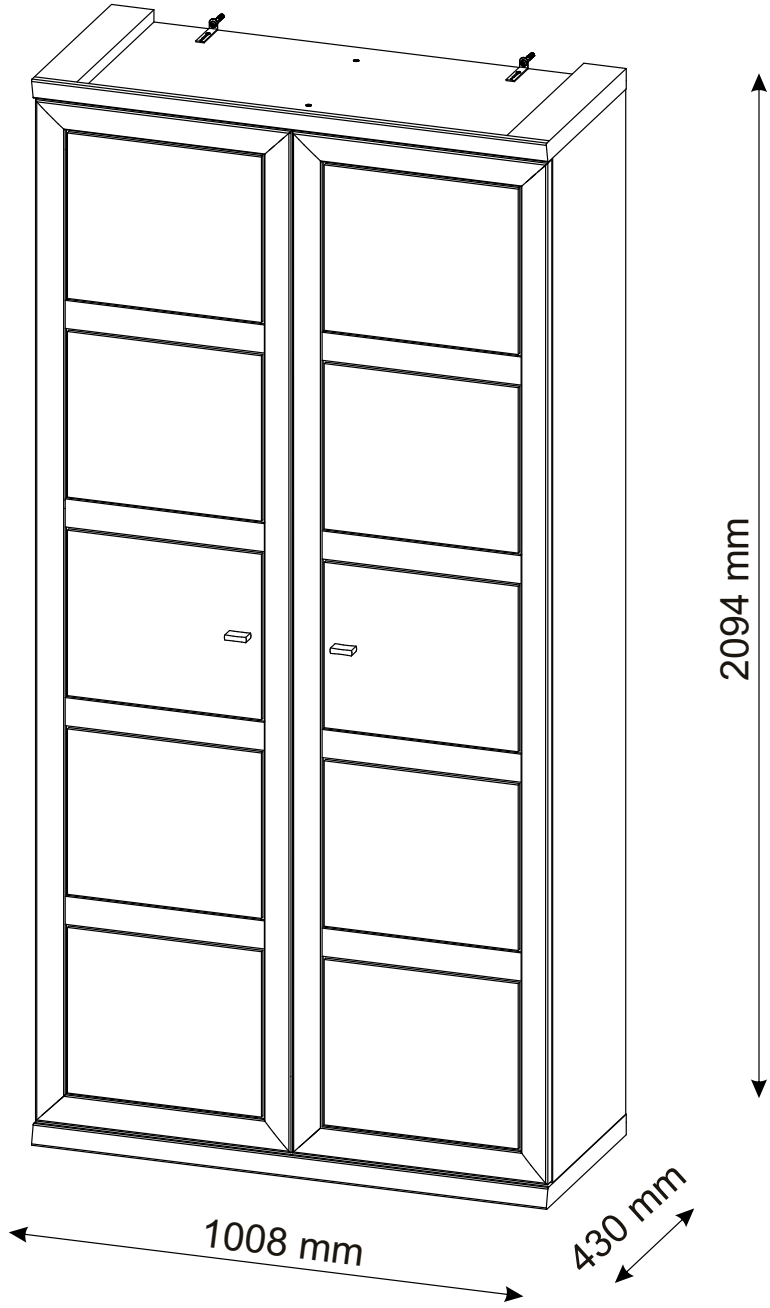

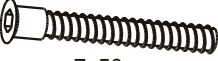

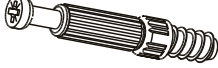

CAMRON - Aktenschrank gross 2T

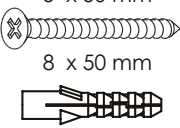
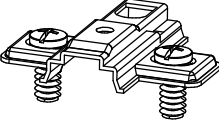
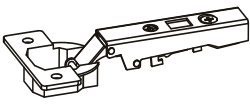

Ø8

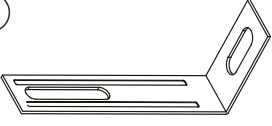

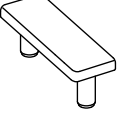
CAMRON - Aktenschrank gross 2T

B1  7x50mm x4	C0  x8	C2  x8
D0  3x15mm x24	D10  4x16mm x16	D21  5x13mm x2
E0 5 x 50 mm 8 x 50 mm  x2	J3  x8	J10  x8
K 4mm  x1	L6  x2	H2  4x22mm x4
M1  x24	P0  x2	Q3  x32
T4  x6	U3  x4	

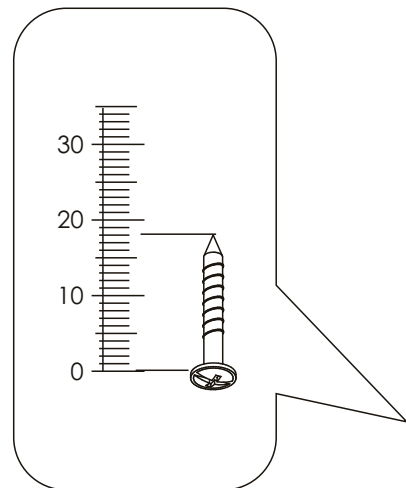
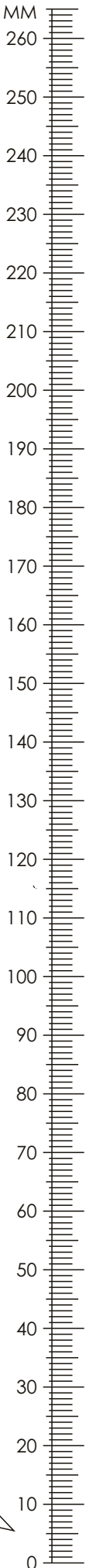

CAMRON - Aktenschrank gross 2T

1	2008	393	16	x2	1/4
2	2008	393	16	x1	2/4
3	1008	430	40	x1	4/4
4	1008	430	40	x1	4/4
5	479	372	16	x8	2/4
6	2018	489	3	x2	3/4
7	2000	500	25	x2	3/4
					4/4

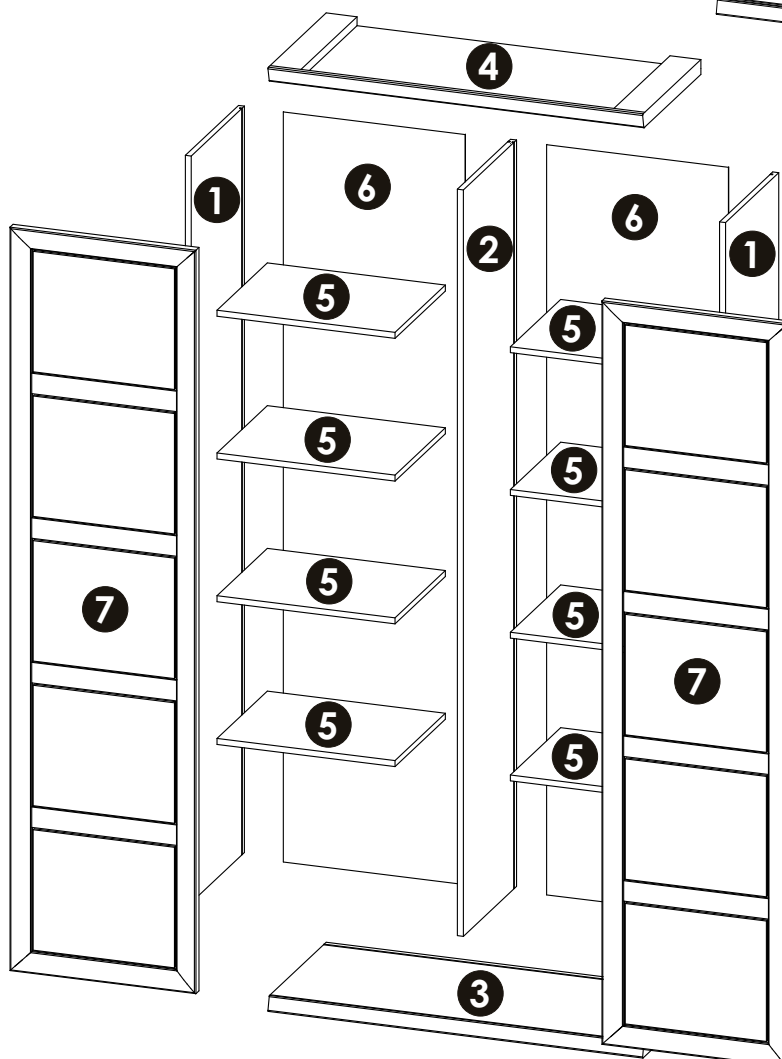
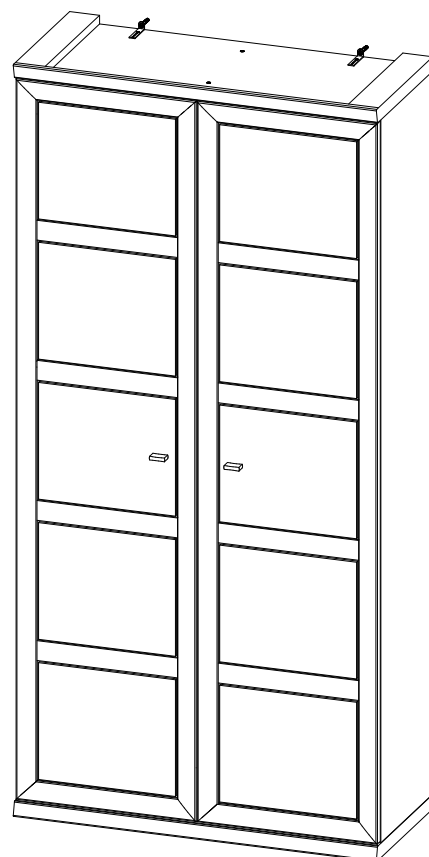

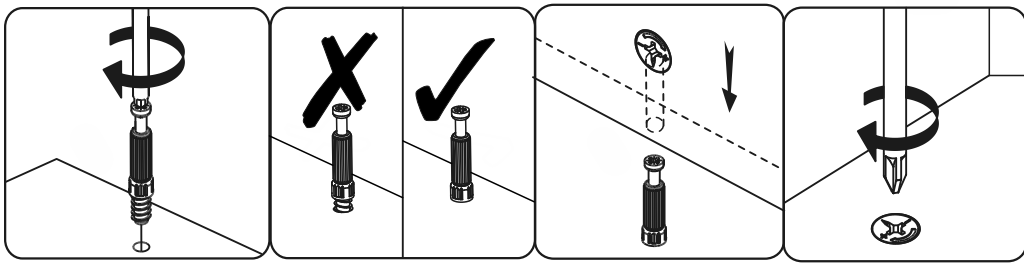

1 ▶

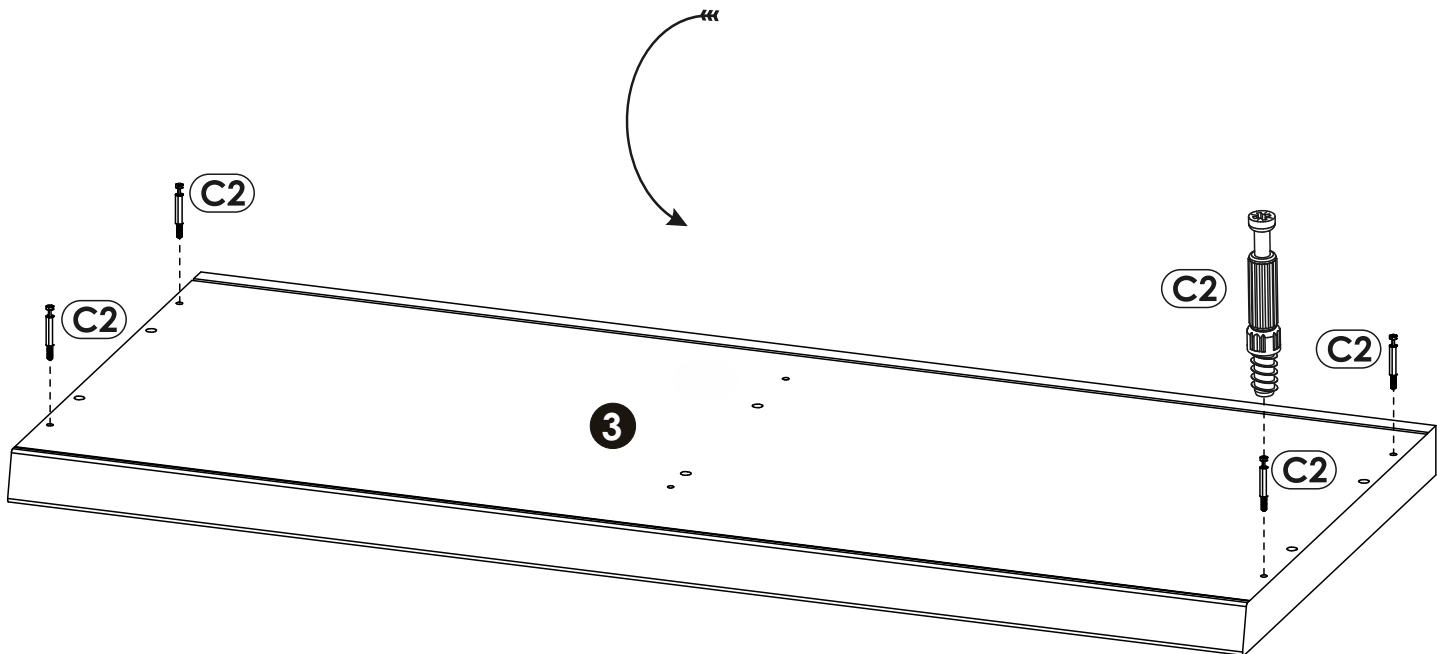
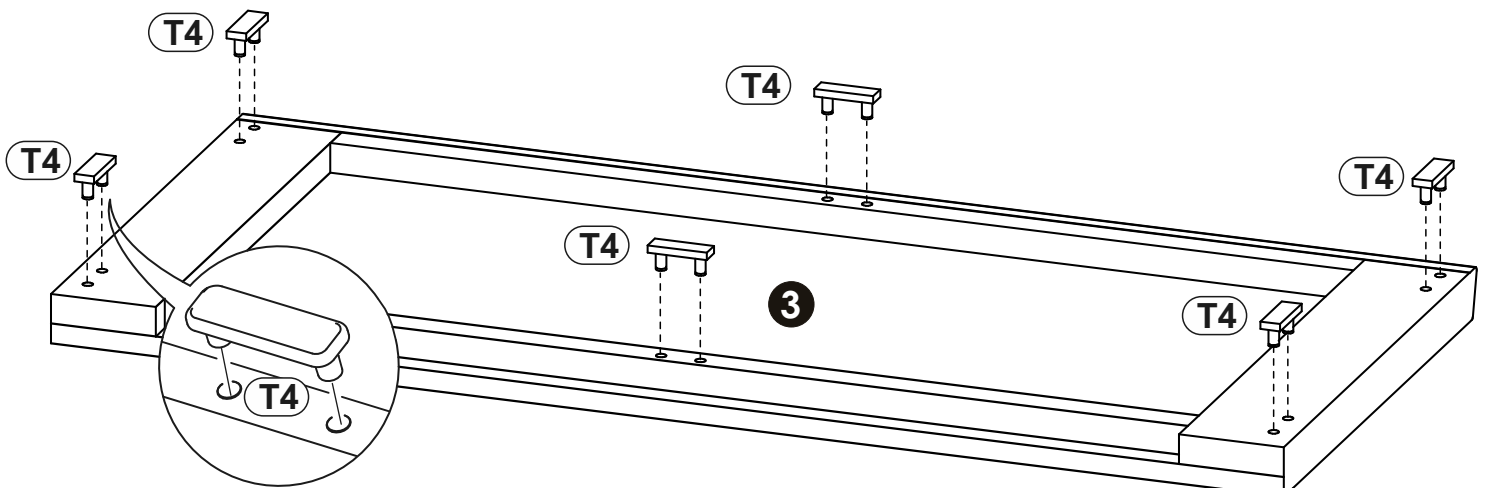
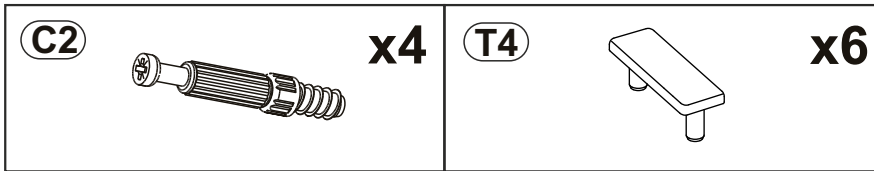

2 ▶

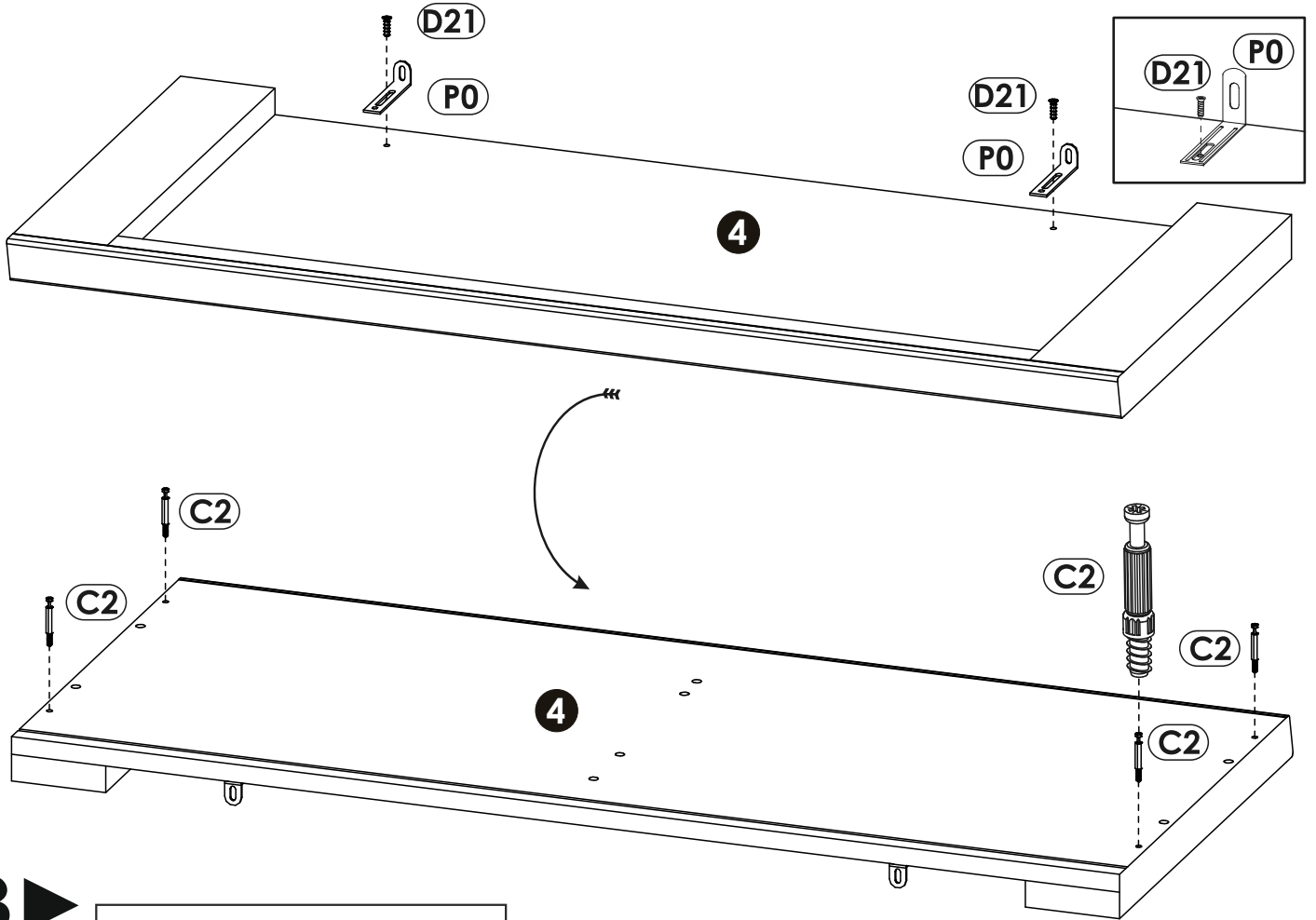
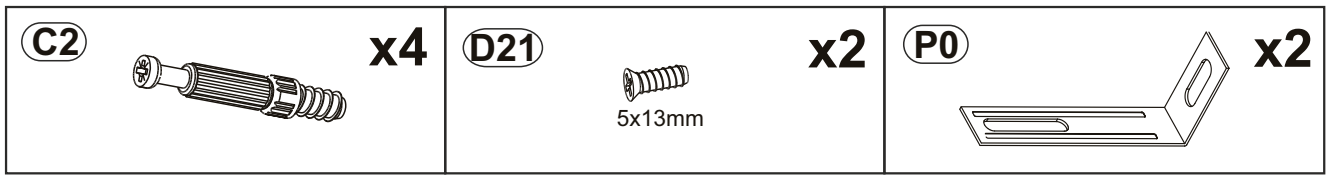

3 ▶

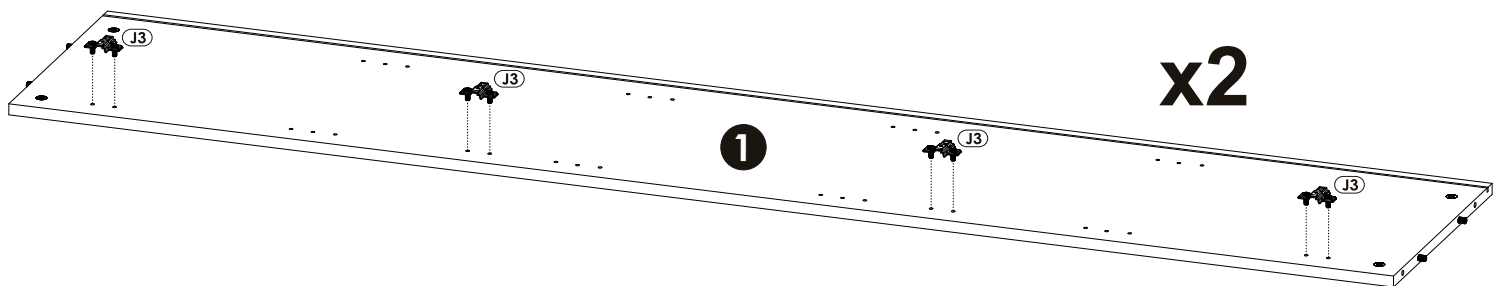
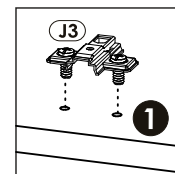
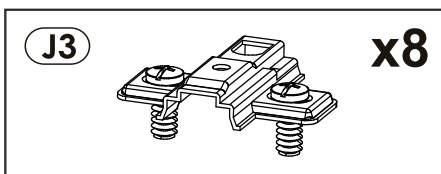

4 ▶

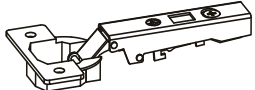
D10	 4x16mm	x16	J10		x8
------------	---	------------	------------	--	-----------

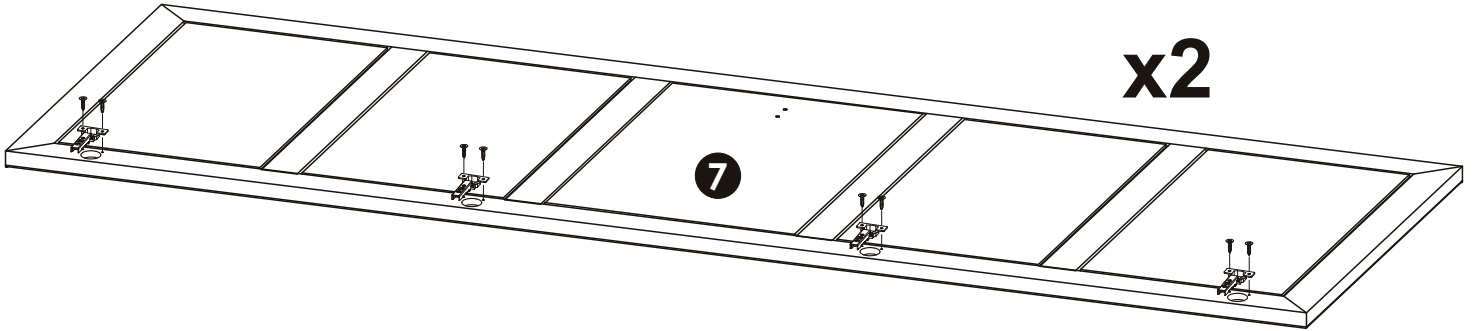
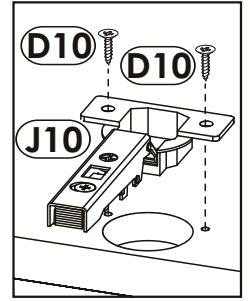

x2

5 ▶

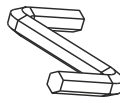

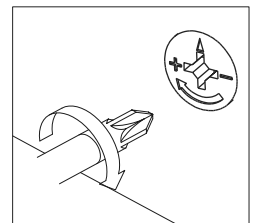
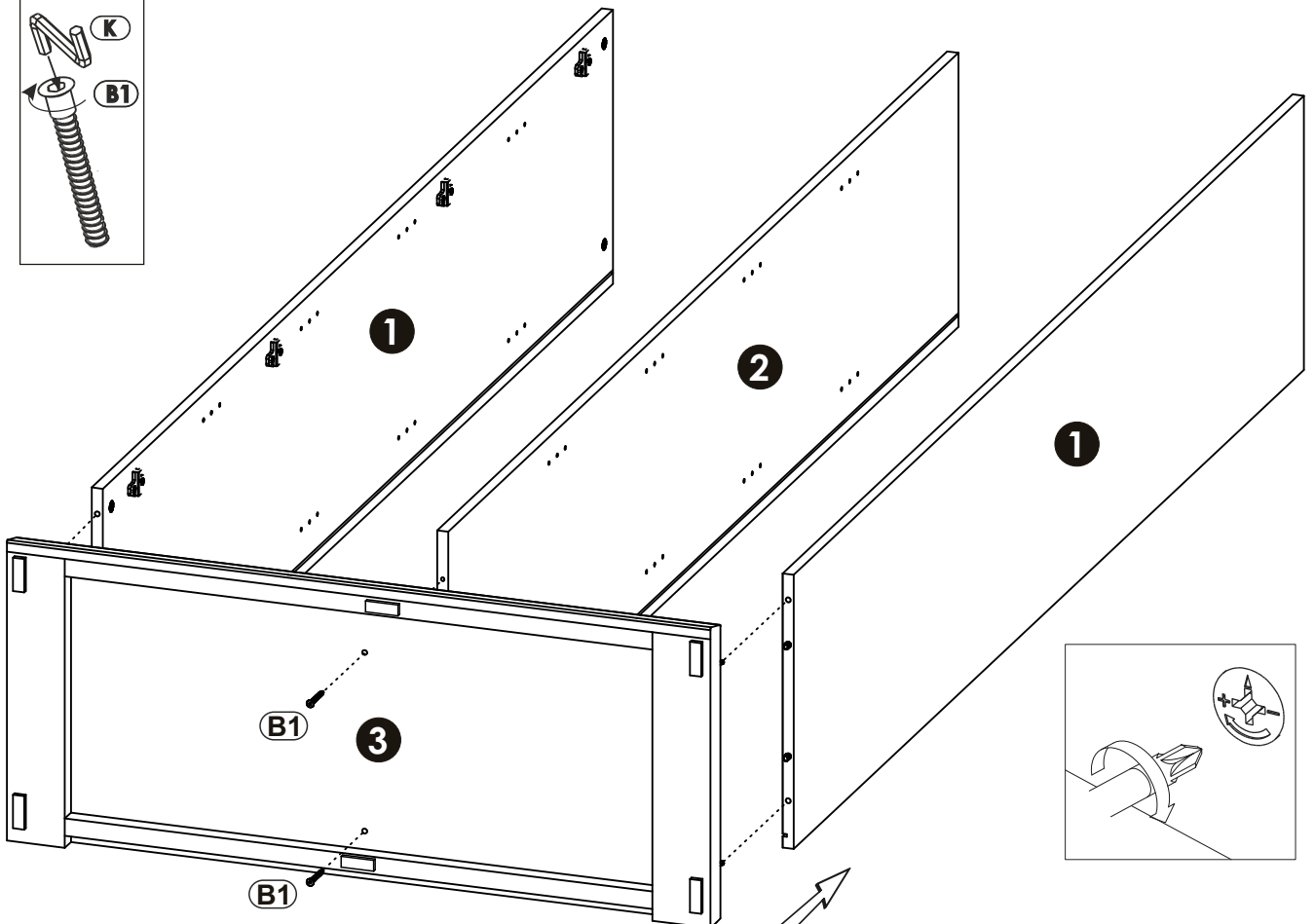
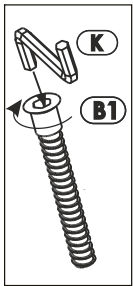
B1	 7x50mm	x2	K	 4mm	x1
-----------	---	-----------	----------	--	-----------

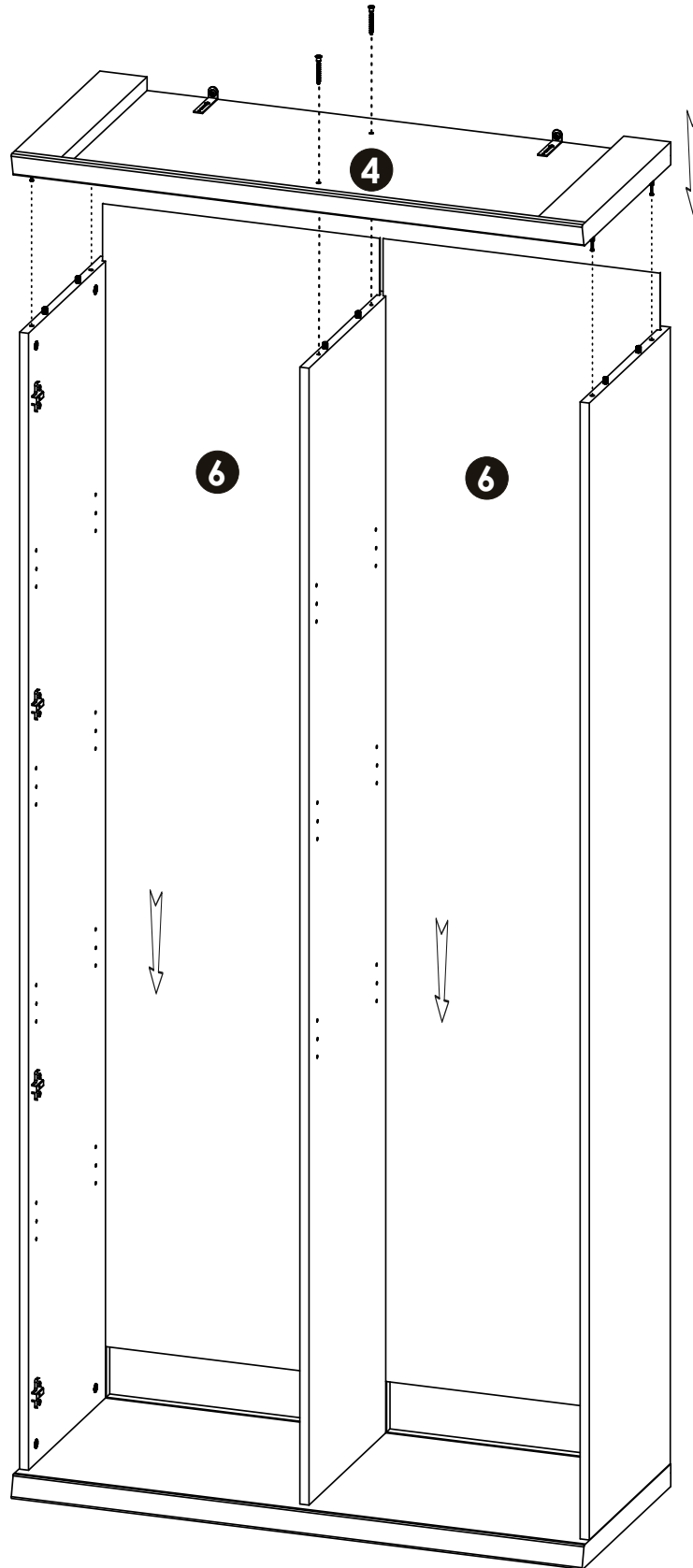
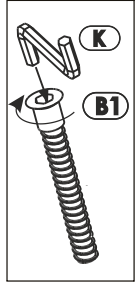
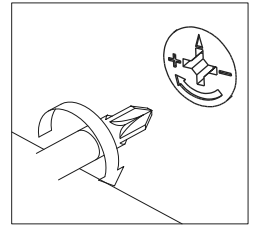
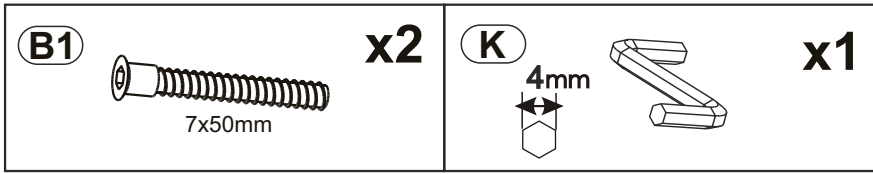

6



7 ▶

D0	 3x15mm	x24	M1		x24
-----------	---	------------	-----------	---	------------

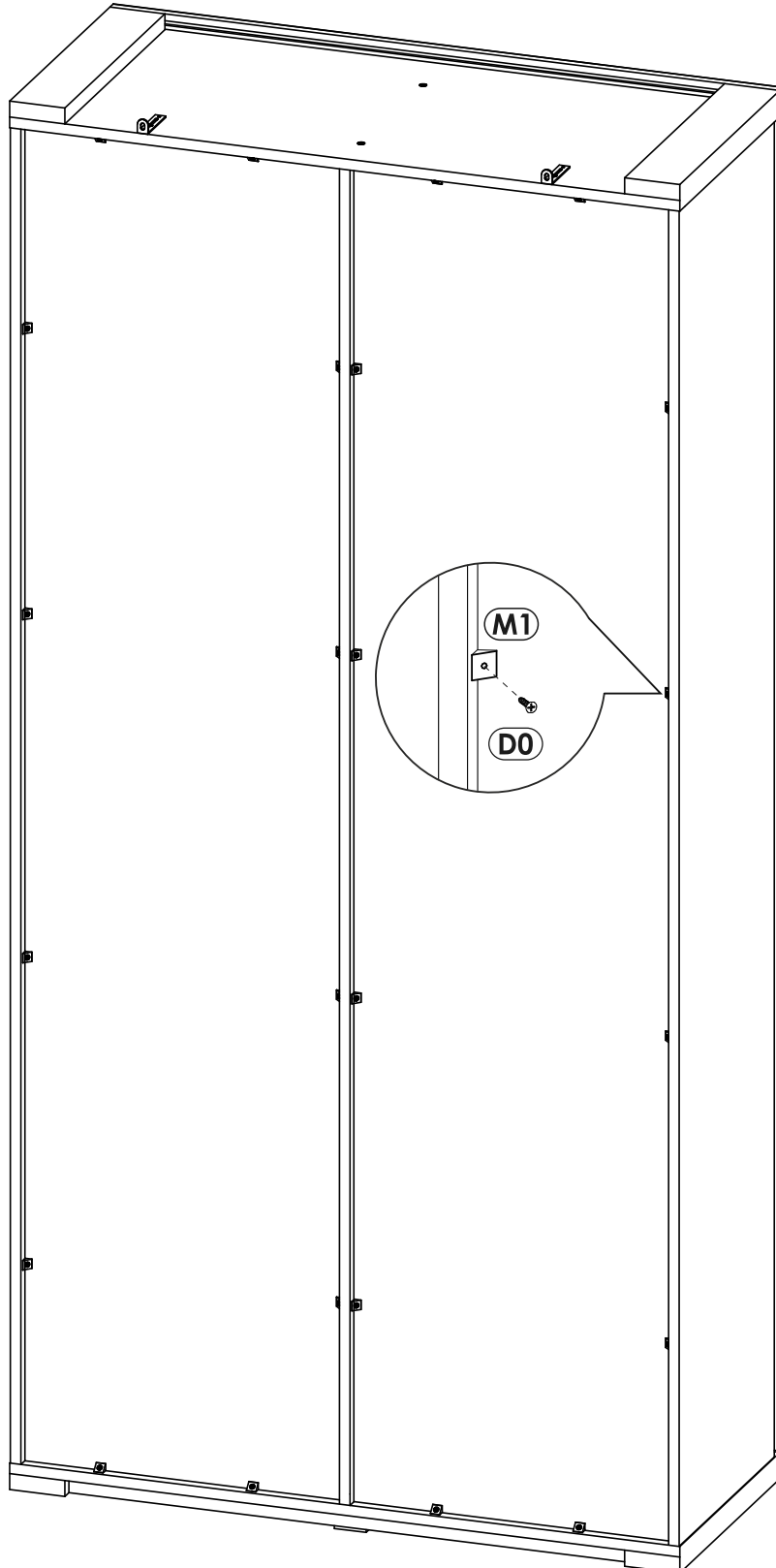
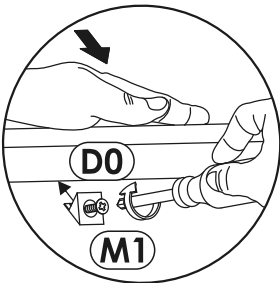
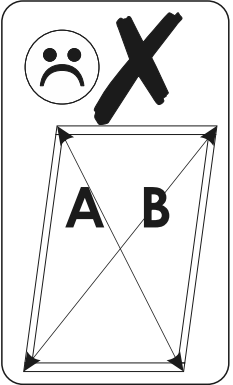
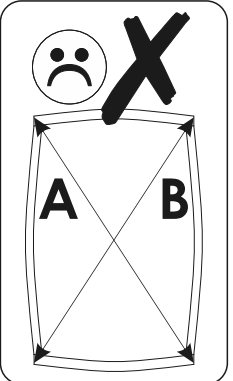
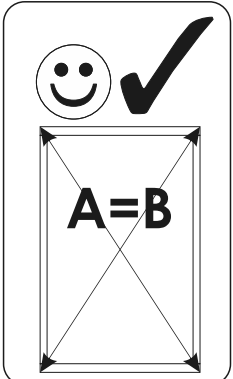

8 ▶

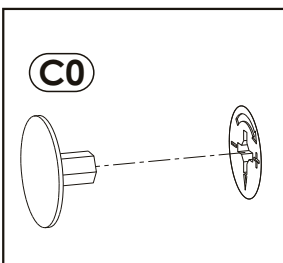
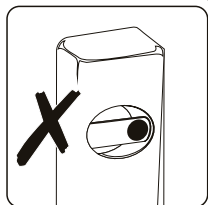
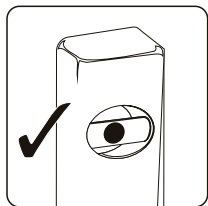
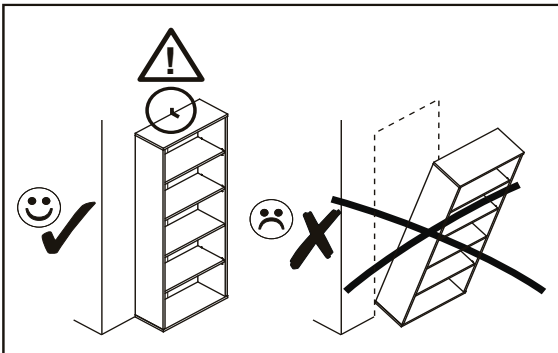
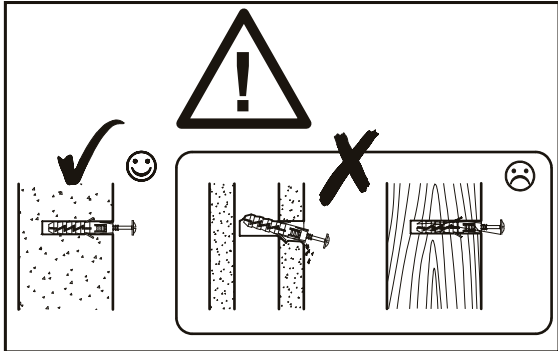
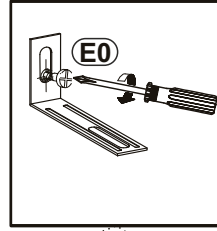
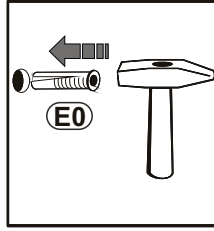
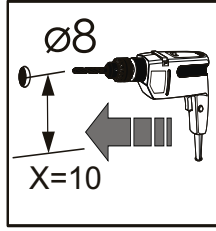
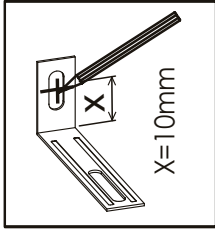

E0	5 x 50 mm 8 x 50 mm	x2	C0		x8
-----------	------------------------	-----------	-----------	--	-----------

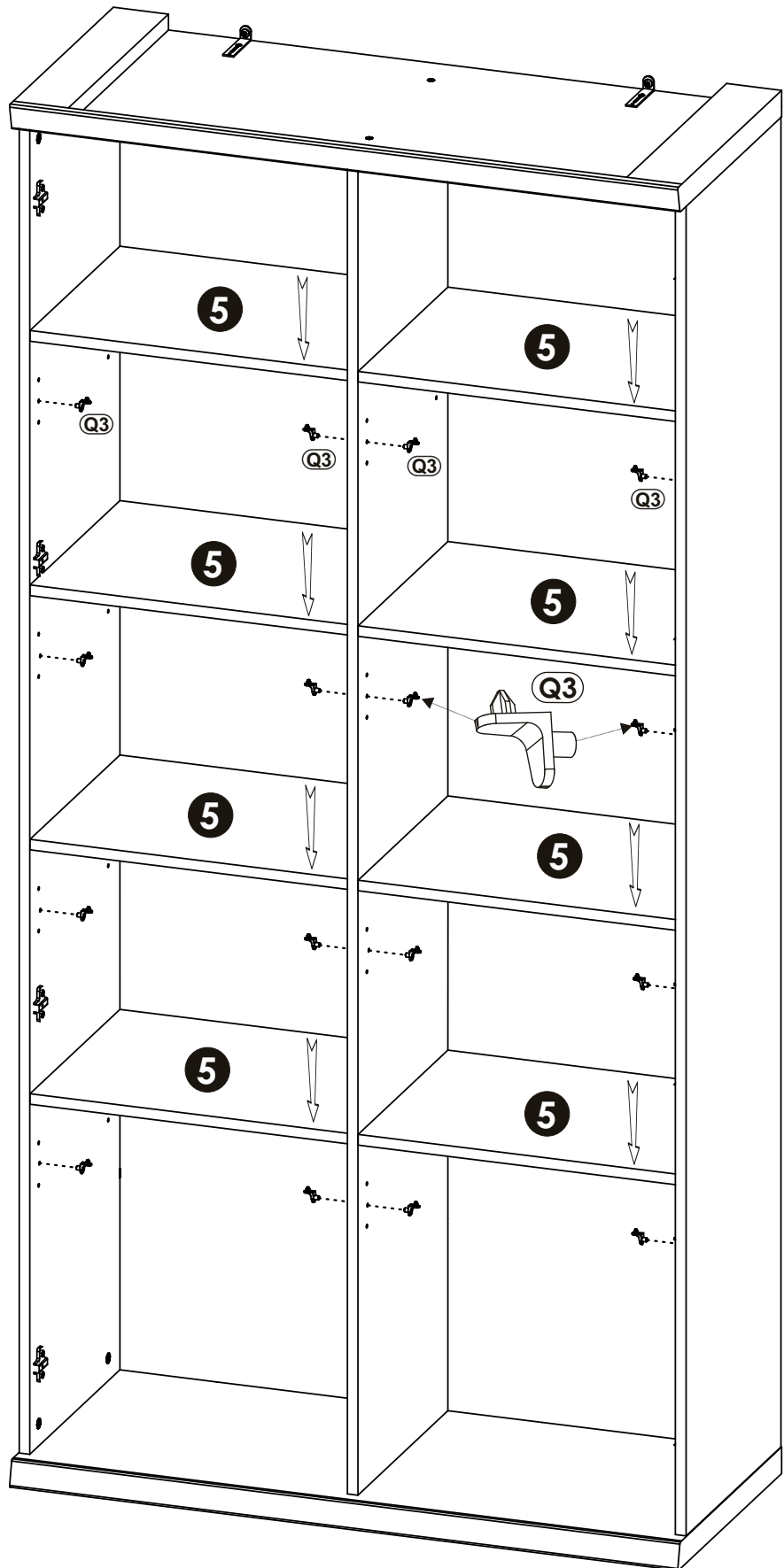
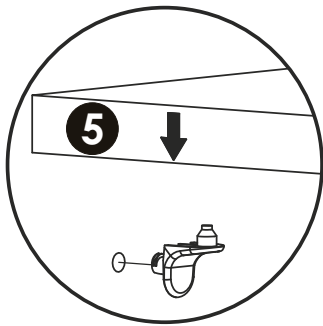
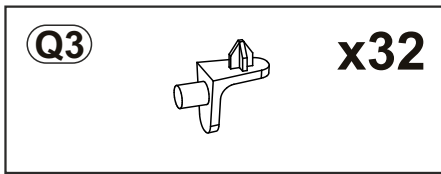

9 ▶



10 ▶

(H2) 4x22mm 	x4	(L6) 	x2	(U3) 	x4
--	-----------	--	-----------	--	-----------

