

T1 Bitte unbedingt ausfüllen!

Name	
Strasse	
Plz	Ort
Tel.	

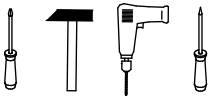







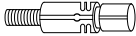

T2 Sehr geehrte Kunden,
wir freuen uns, dass Sie sich für ein Produkt aus dem Hause Pelipal entschieden haben. Sollte es trotz aller Bemühungen unsererseits, Ihnen ein qualitativ hochwertiges Möbelstück zu liefern, zu Fehlteilen kommen, schicken Sie bitte dieses ausgefüllte Blatt an
Fax.: **+49 3443/434354**
E-Mail: **weissenfels.ersatzteile@pelipal.de**
Bitte beachten Sie, dass Bauteile über 800mm Länge und 350mm Breite direkt bei Ihrem Möbelhändler zu beanstanden sind. Zur Reklamationsbearbeitung ist es unbedingt erforderlich **die Artikelnummer des Schrankes**, welche auf dem Etikett ersichtlich ist und den Markt, wo das Möbel erworben wurde anzugeben. Ausserdem tragen Sie unten bitte die benötigte Stückzahl ein. Viel Spass mit Ihrem neuen Badmöbel! Ihr Pelipal Team

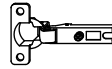
-

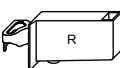

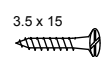
T3 Für den Zusammenbau sind 2 Personen erforderlich.

T4 Montage-Richtzeit 3 Stunden

12 x a  DÜB-SMD-000005	Stück	12 x b  EXZENTER-000015	Stück	4 x c  ZPL-016X000	Stück	4 x d  TBD-26-115X00	Stück	2 x e  GRI-096-947010	Stück
8 x f  AUF-001-000080	Stück	2 x g  AUF-001-000090	Stück	2 x h  AUF-001-000020	Stück	8 x k  SCH-SPA-035X015	Stück	15 x l  NAGEL-025X001	Stück
4 x m  TRÄ-001-000020	Stück	4 x n  SCH-KNO-M04X020	Stück	4 x o  ADK-AL1-005X008	Stück		Stück		Stück

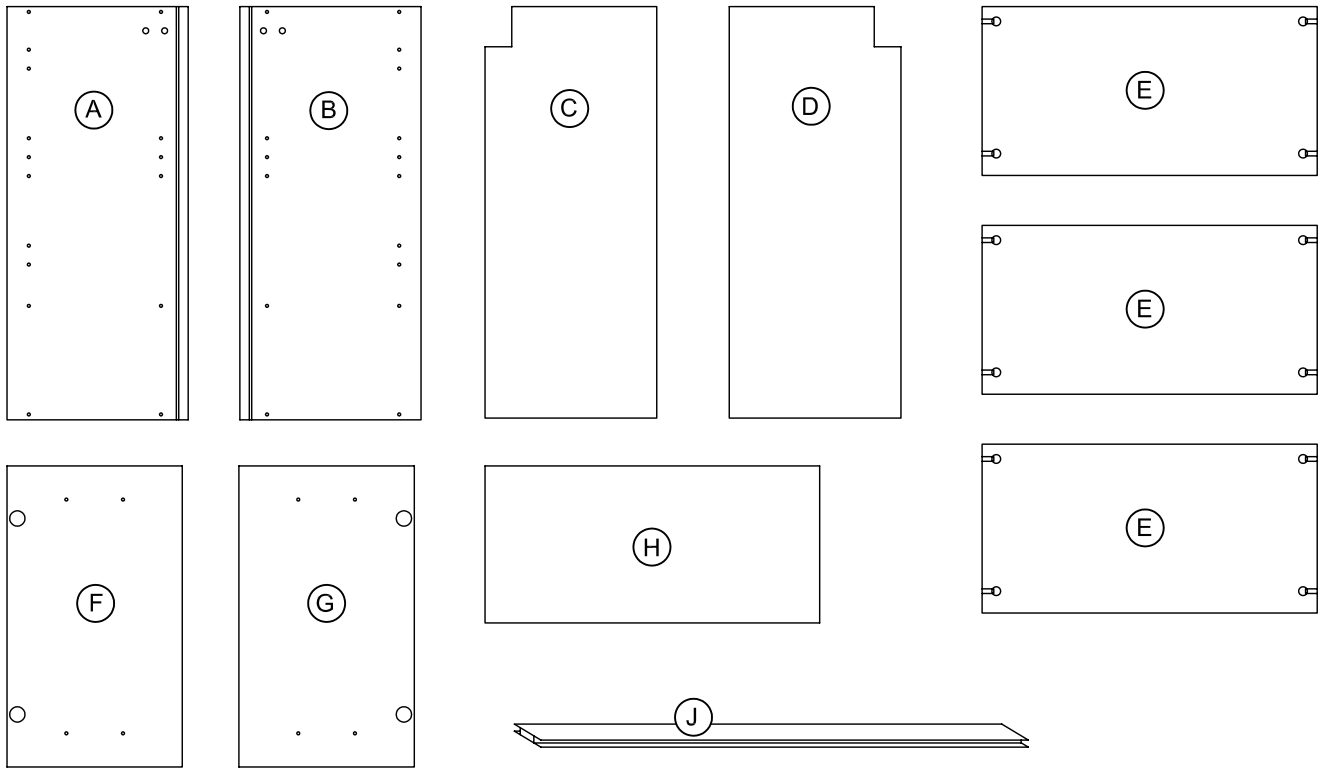

1.

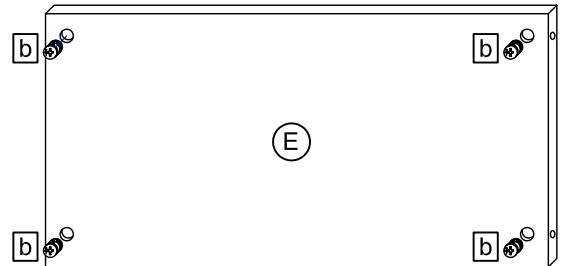
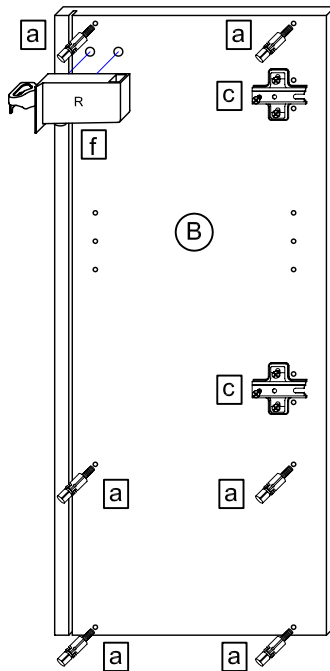
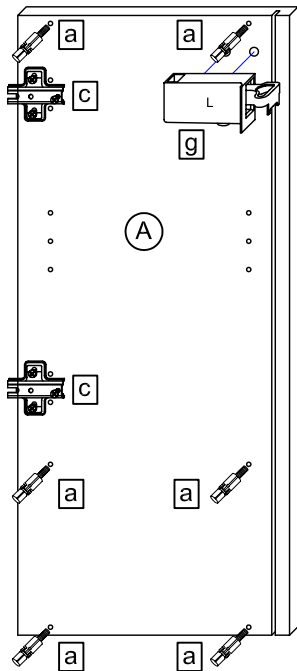
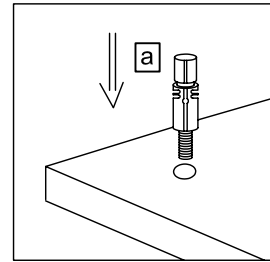
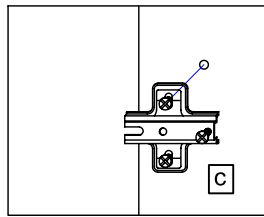
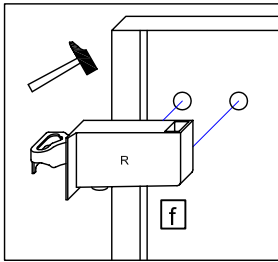
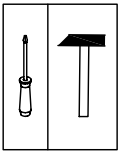

2.

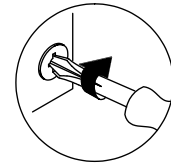
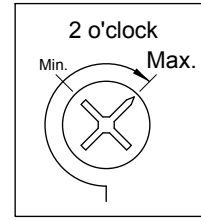
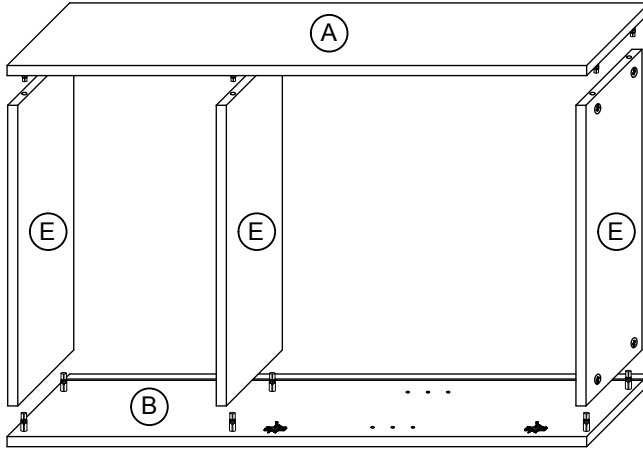
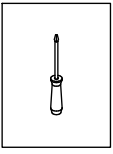

3.

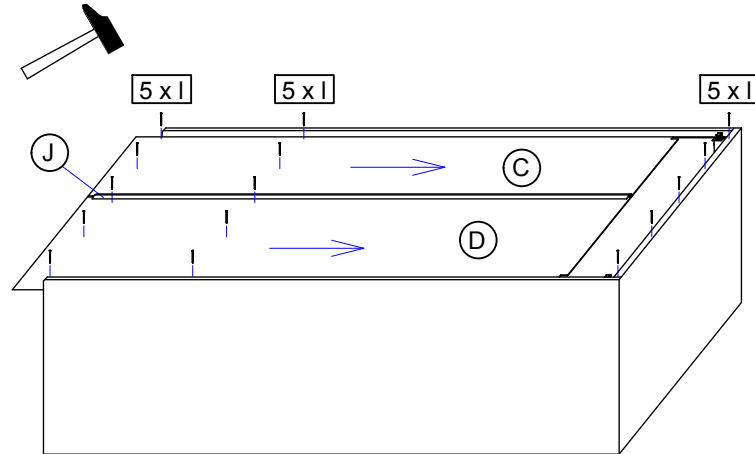
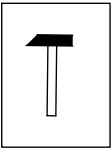

Das Etikett, welches sich unten rechts befindet bitte ausschneiden und auf der Rückwand mit Klebeband (nicht beiliegend) befestigen.



PELIPAL GmbH
Industriestrasse 2

33189 Schlangen
Germany

4.

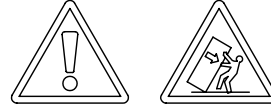
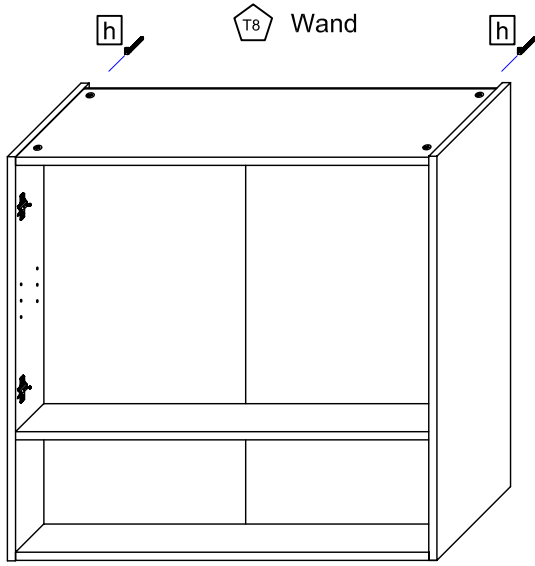
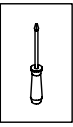

T9 Lassen Sie den Schrank nur durch fachkundige Personen mit für die Wand geeignetem Montagmaterialien montieren.

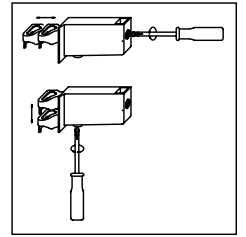
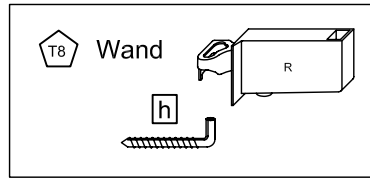

5.

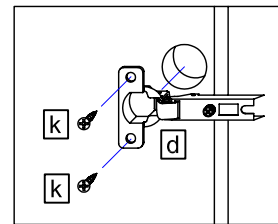
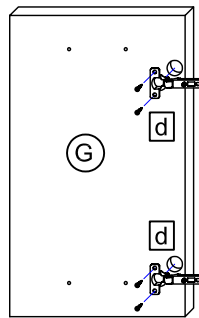
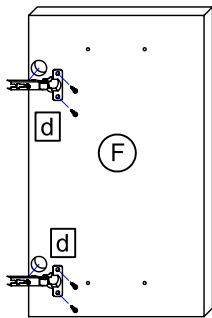
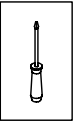

6.

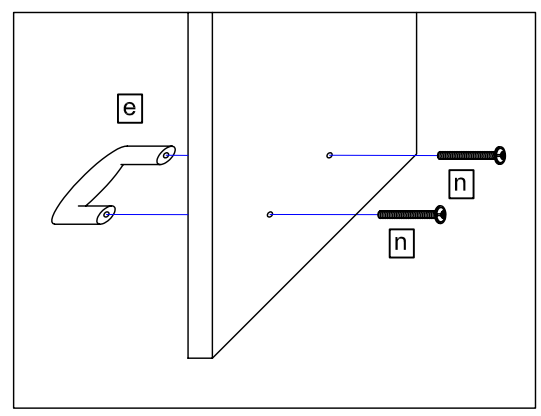
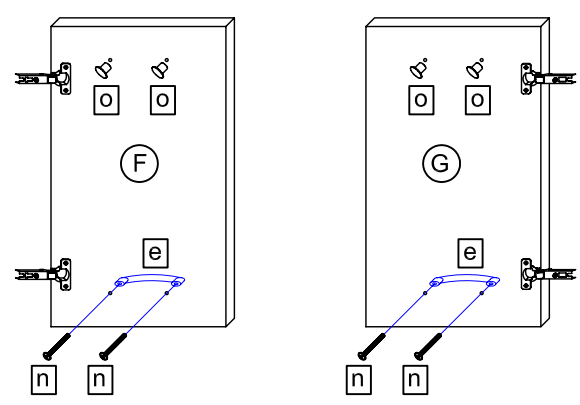
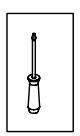

7.

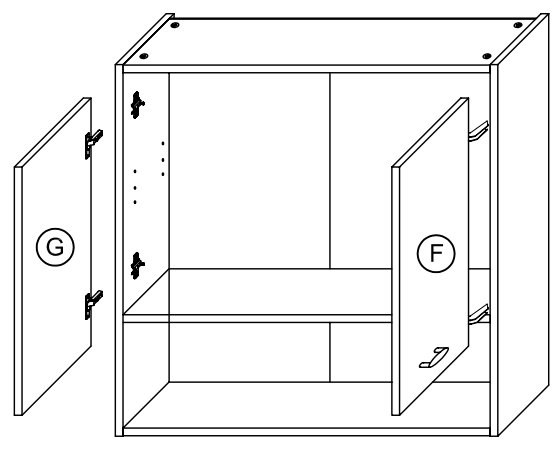
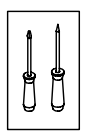

T11 Bei Türmontage das Scharnier einhängen, bis Anschlag öffnen und anschließend festschrauben.

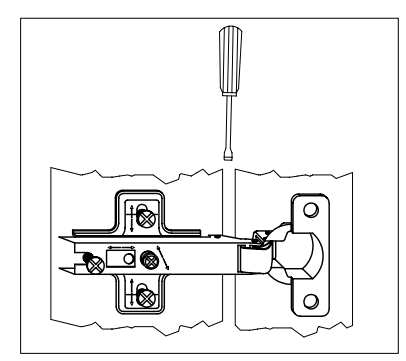
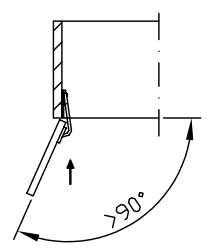

8.

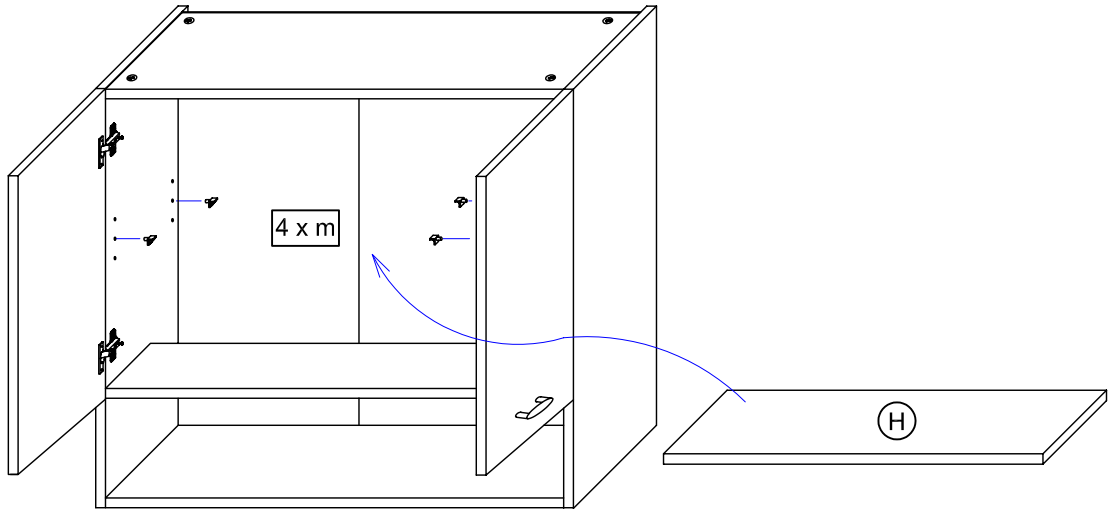

 Das Möbel bitte nur mit einem feuchten Tuch reinigen.