

Nr	Ausmaß			St
1	1918	380	15	1
2	1918	380	15	1
3	570	80	15	1
4	570	359	15	4
5	570	379	15	1
6	570	379	22	1
7	362	584	2	5

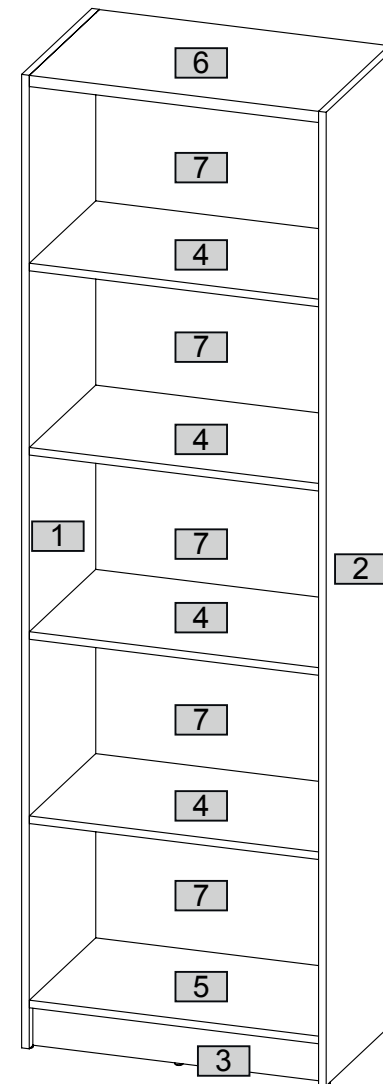

1

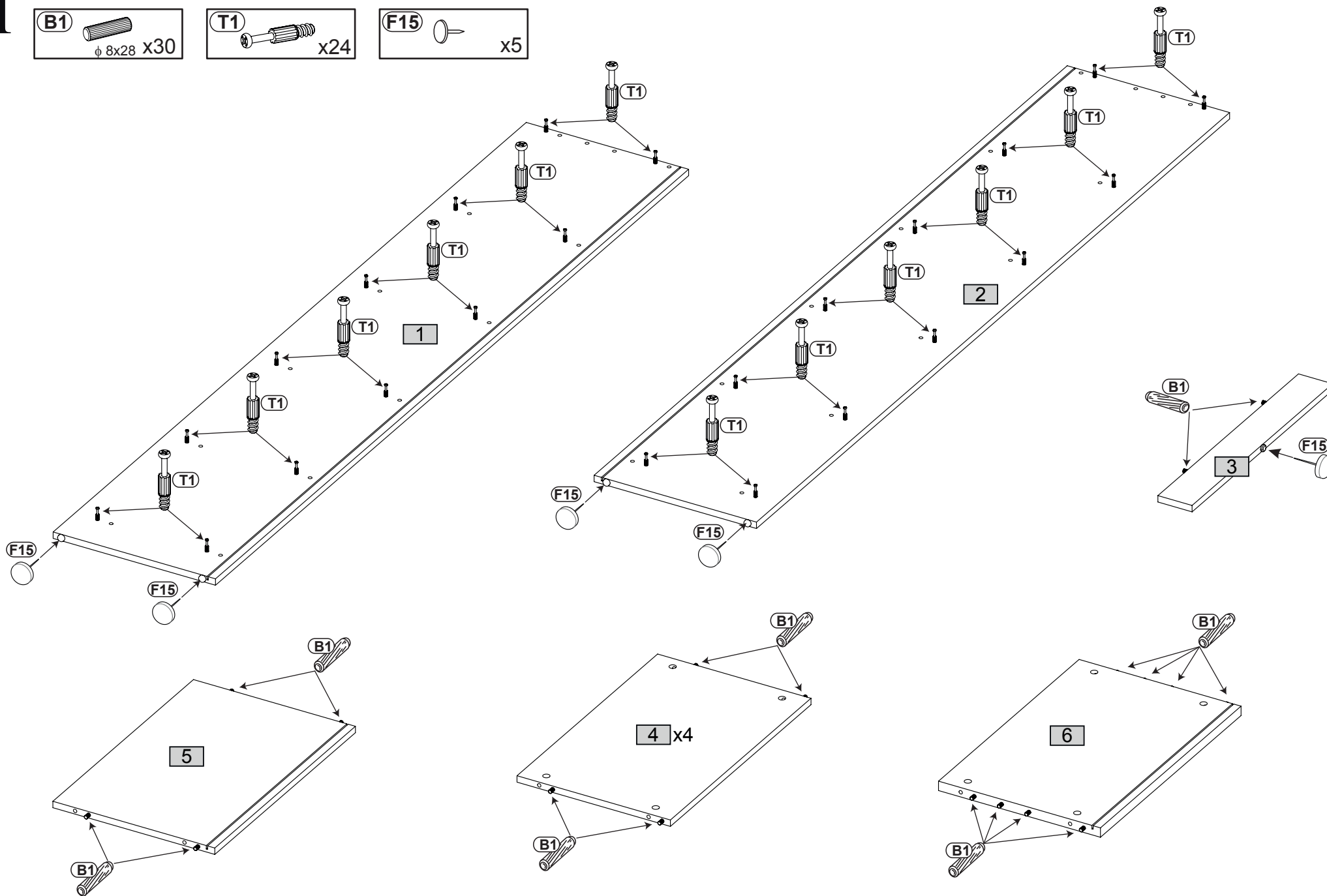
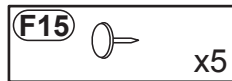
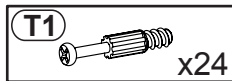
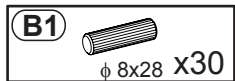

2

M1  x12

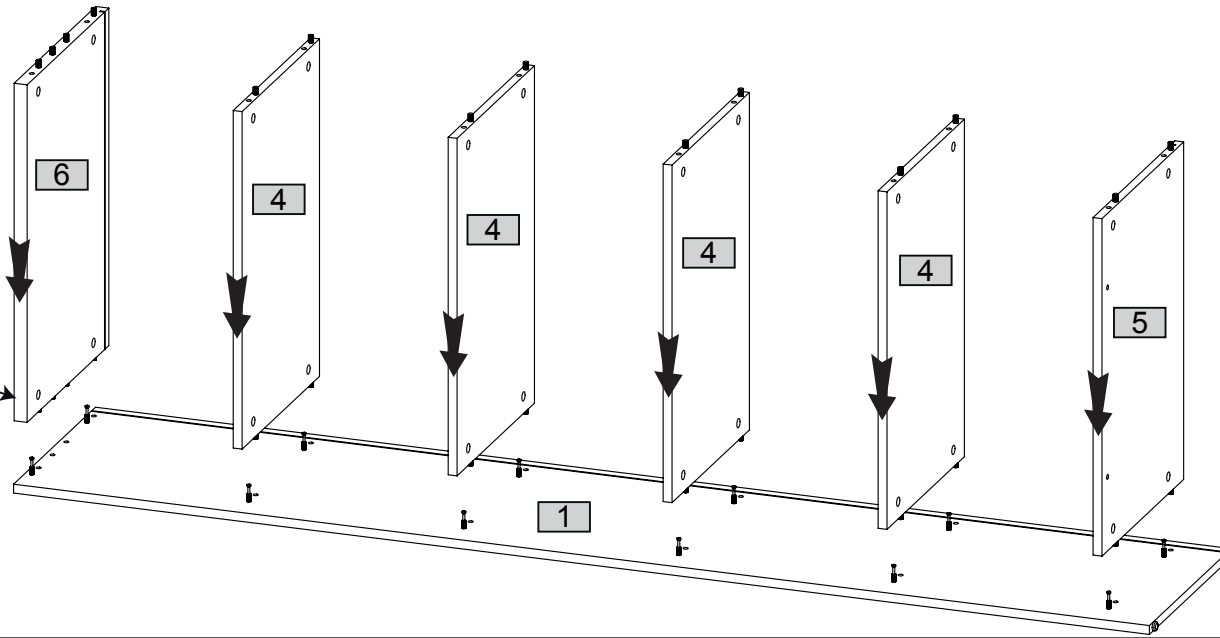
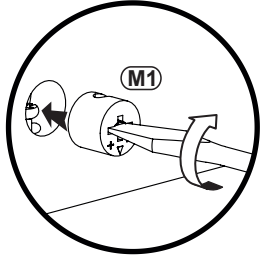

3

M1  x12

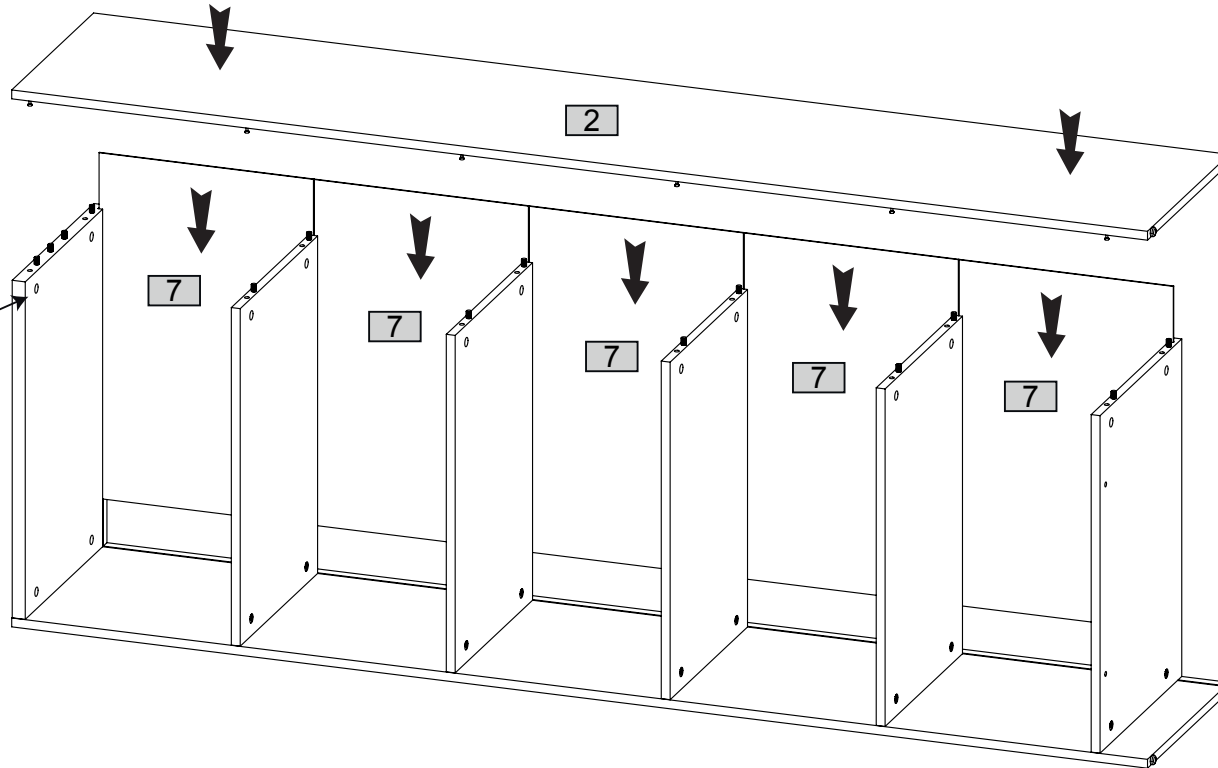
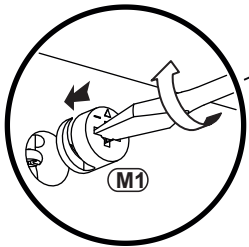

4

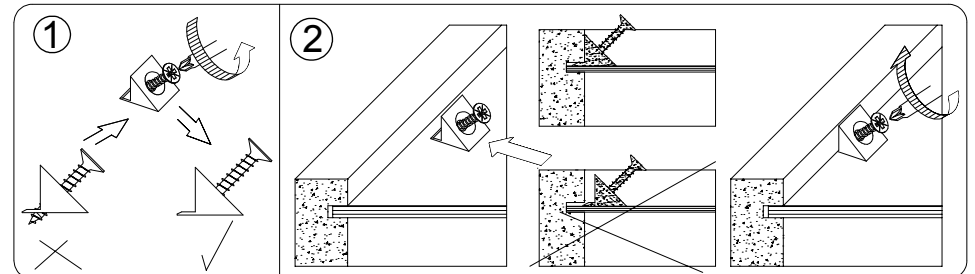
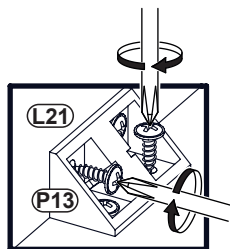
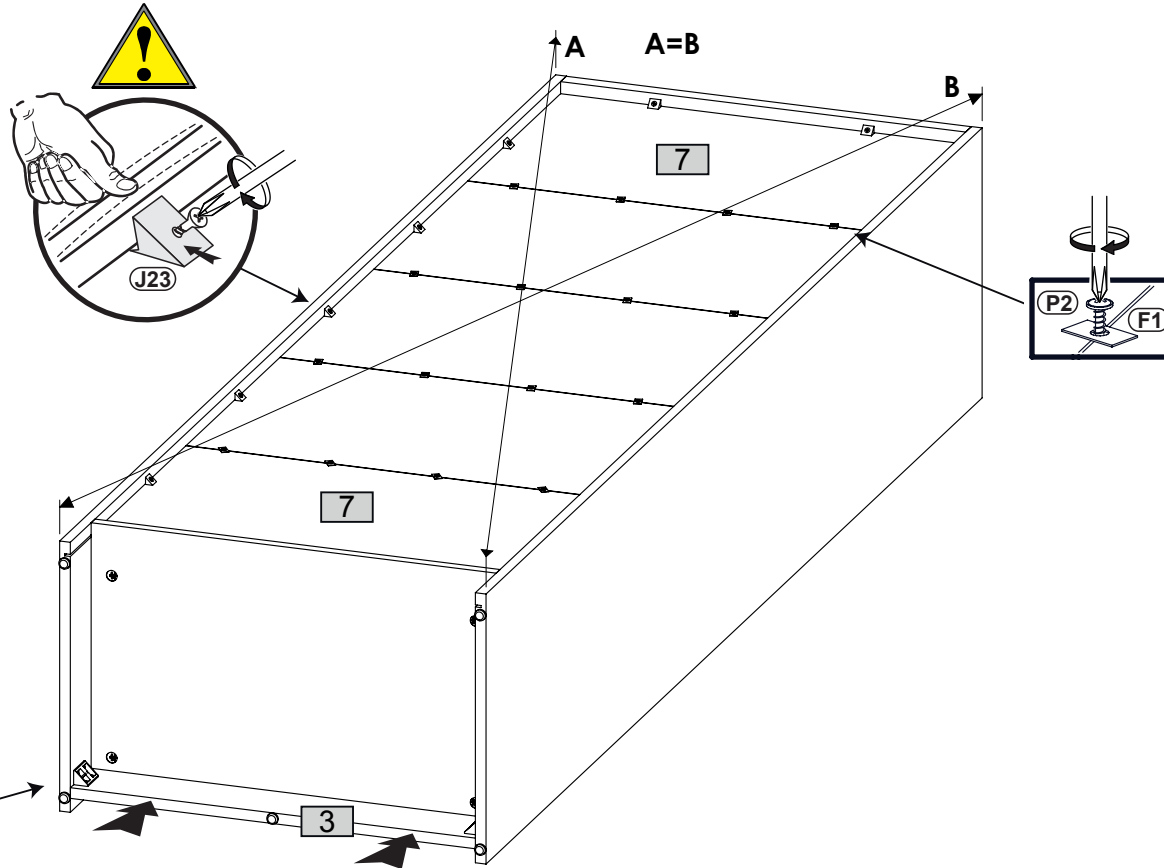
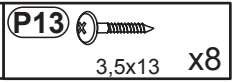
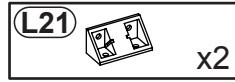
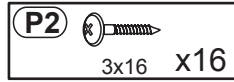
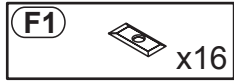
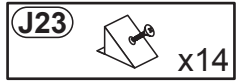

5

