

NOEL

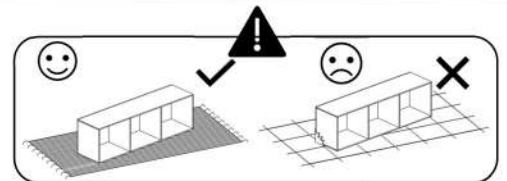

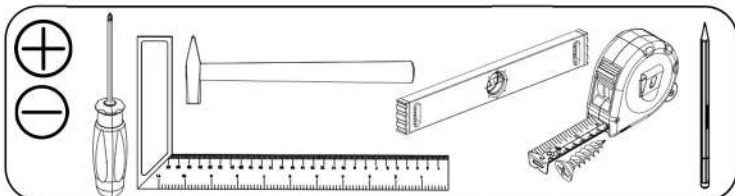

No	T(mm)	L(mm)	W(mm)	pcs.
1	16	970	383	1
2	16	1004	400	1
3	16	1321	400	1
4	16	1321	400	1
5	16	1285	379	1
6	16	428	379	1
7	16	526	379	1
8	16	206	379	1
9	16	206	379	1
10	16	606	379	1
11	16	970	116	1
12	16	526	370	2
13	16	428	370	1
14	16	640	236	1
15	16	640	556	1
16	16	694	440	1
17	16	694	556	1
18	3	1300	440	1
19	3	1300	538	1

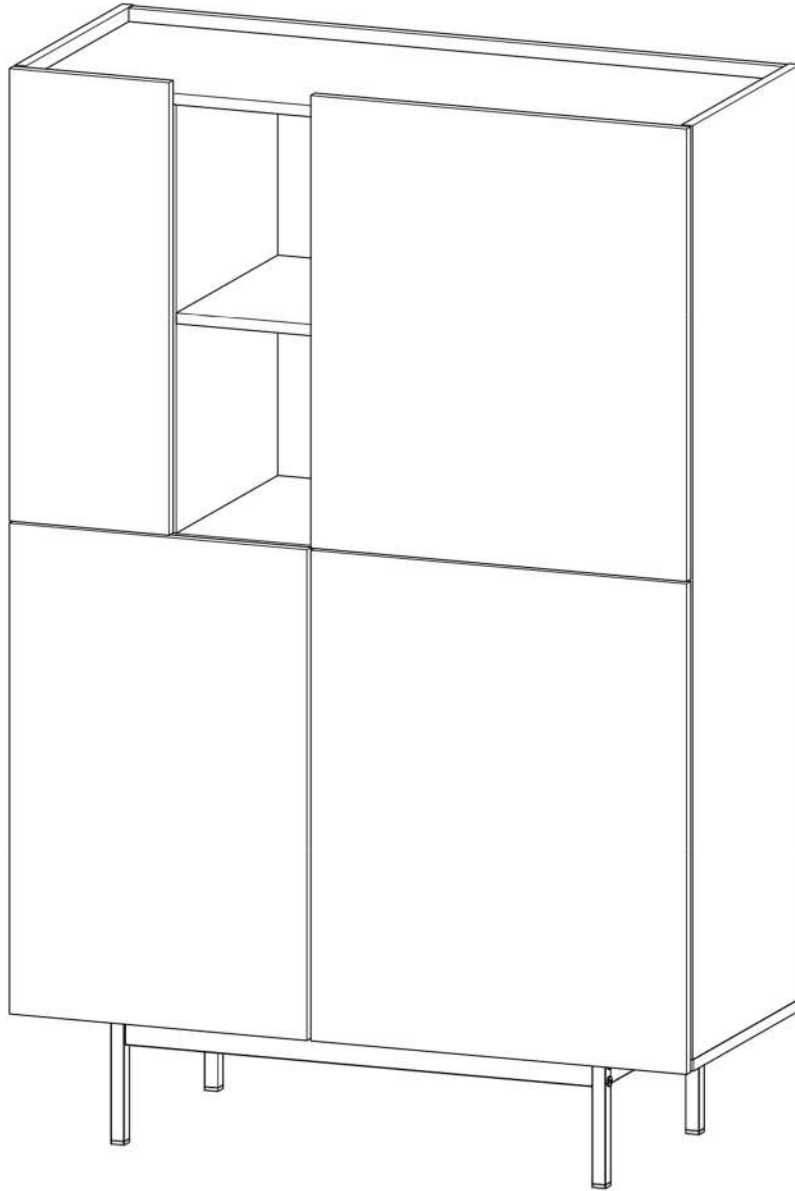
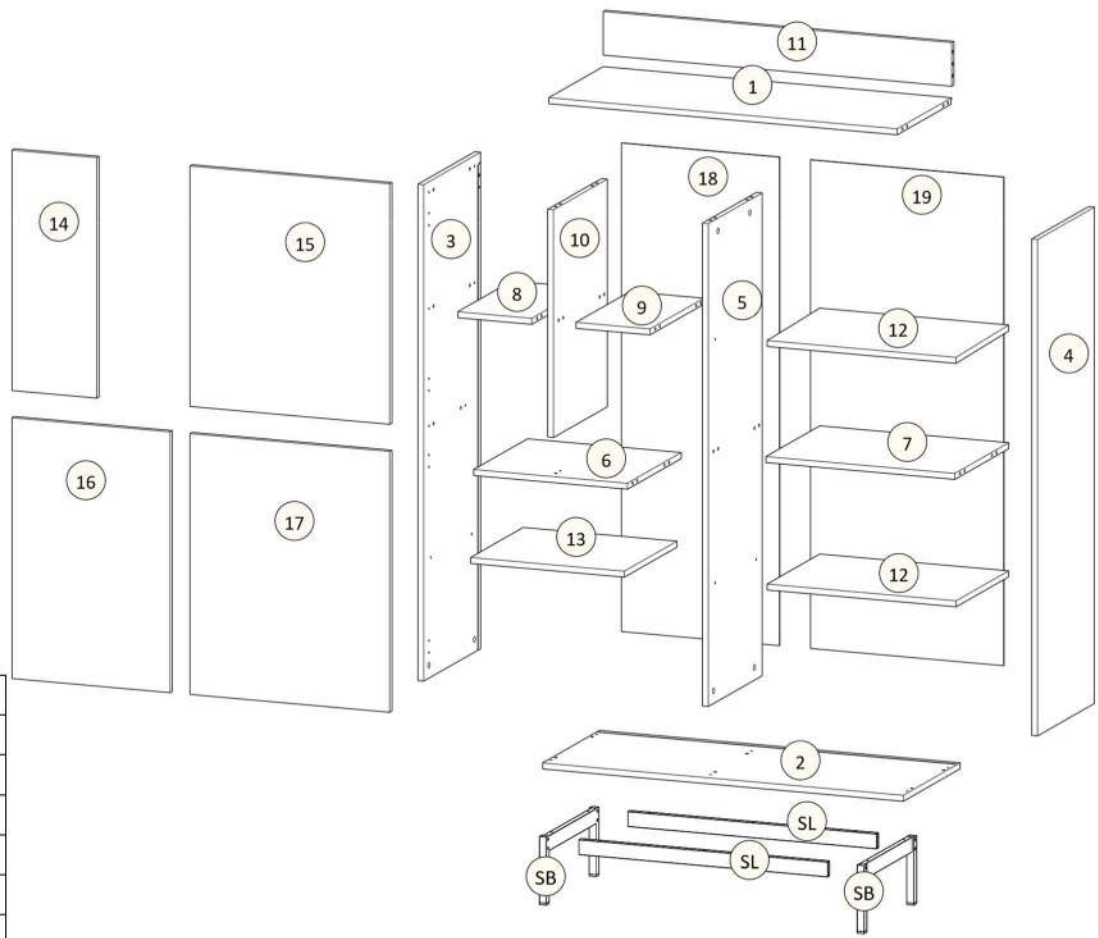
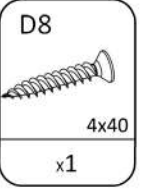
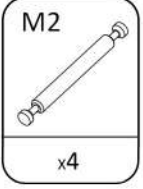
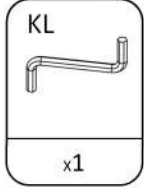
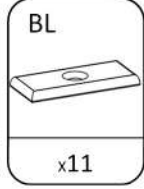
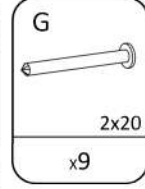
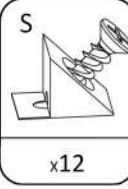
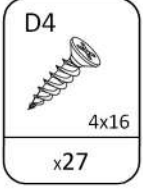
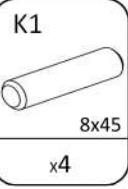
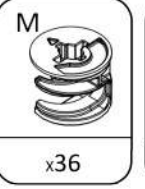
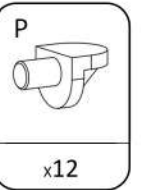
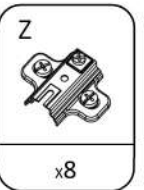
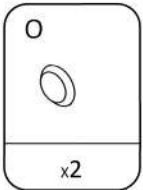
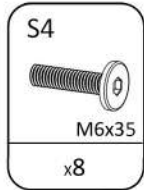
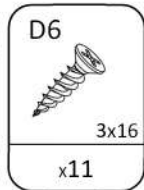
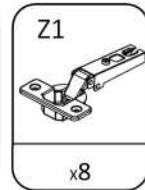
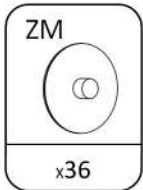
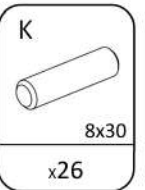
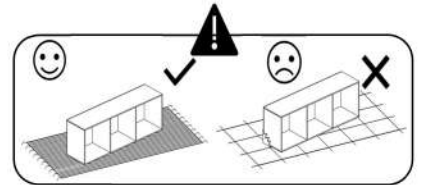

1

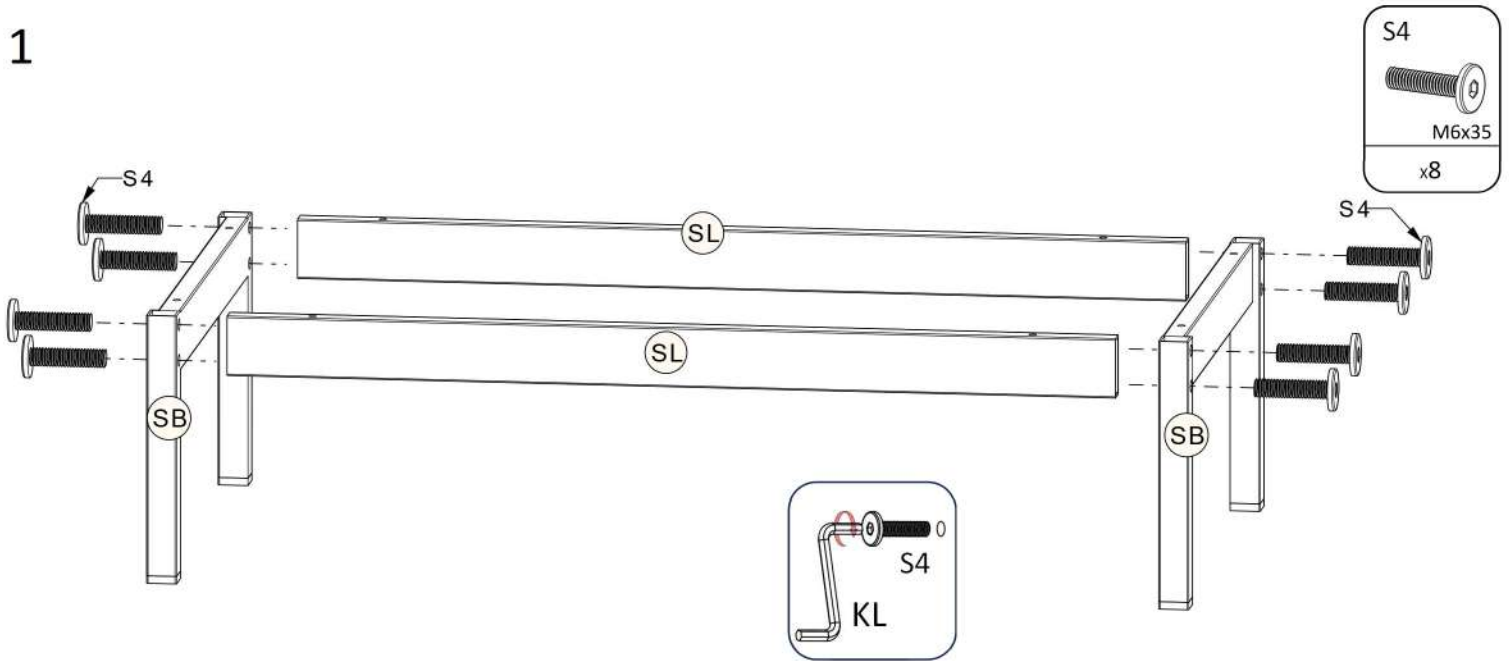

2

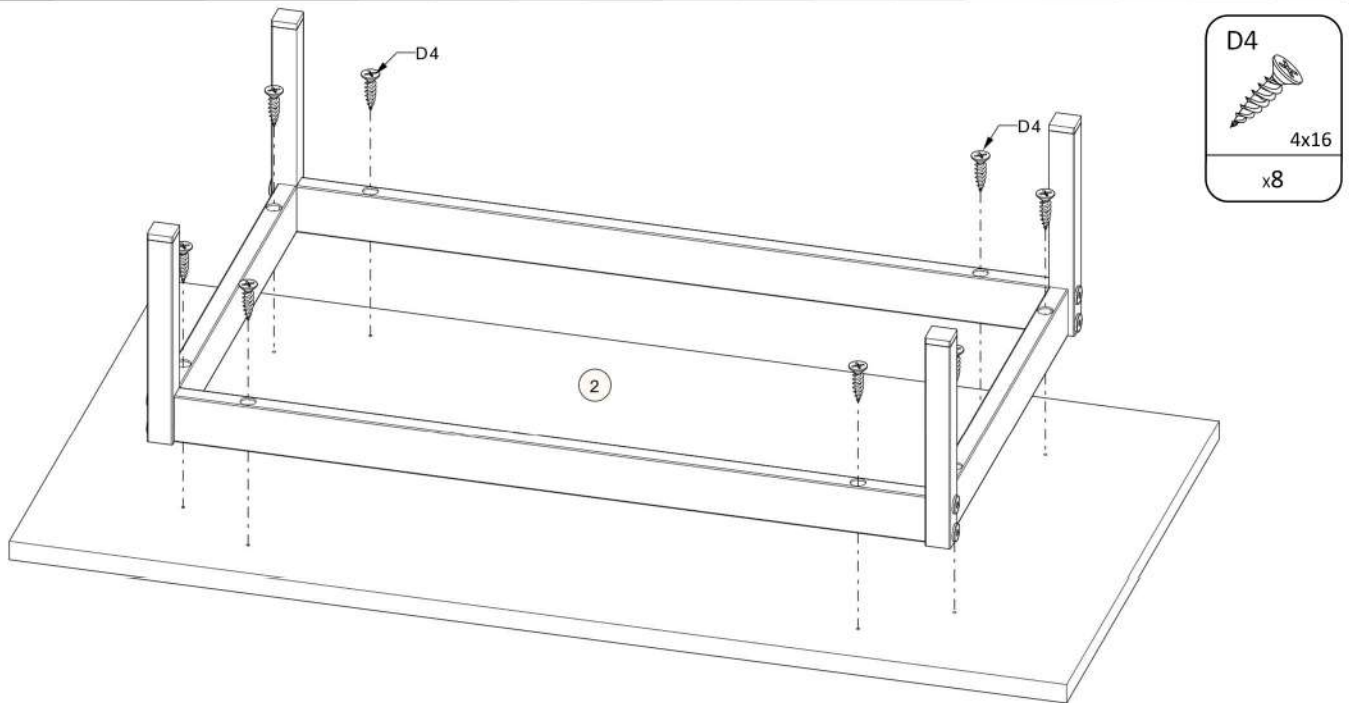

3

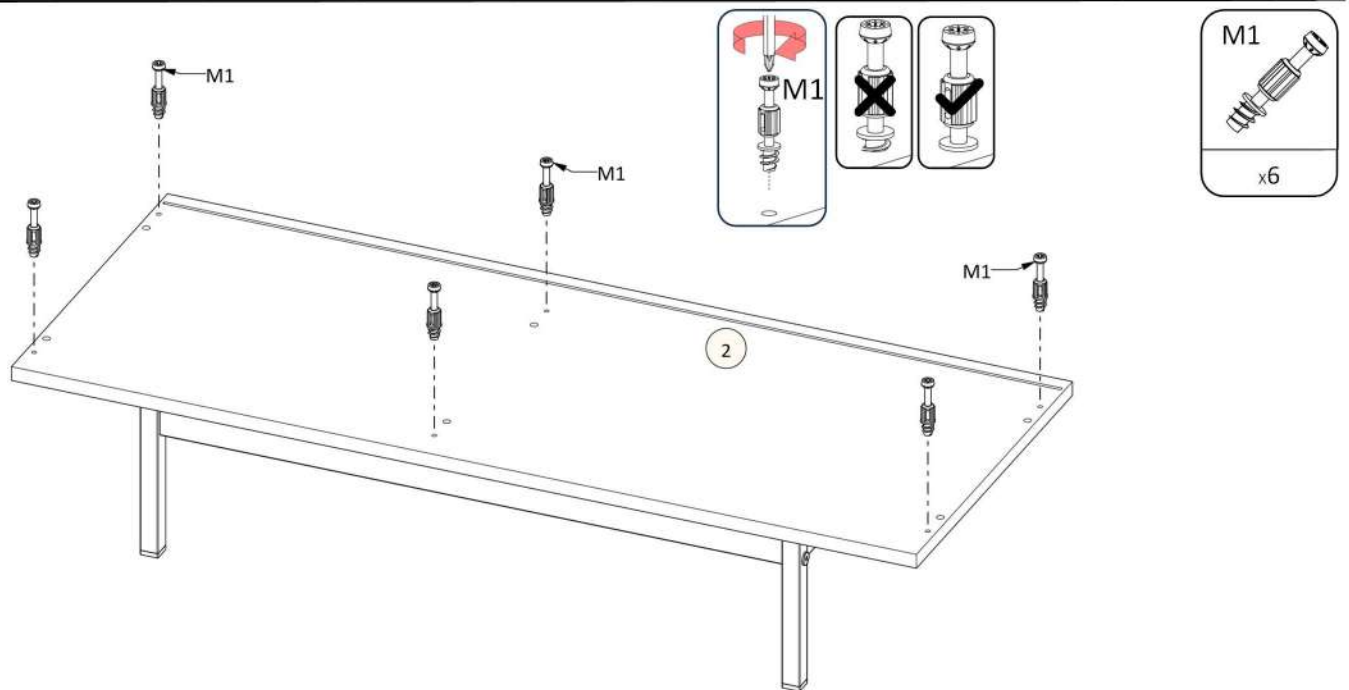

4

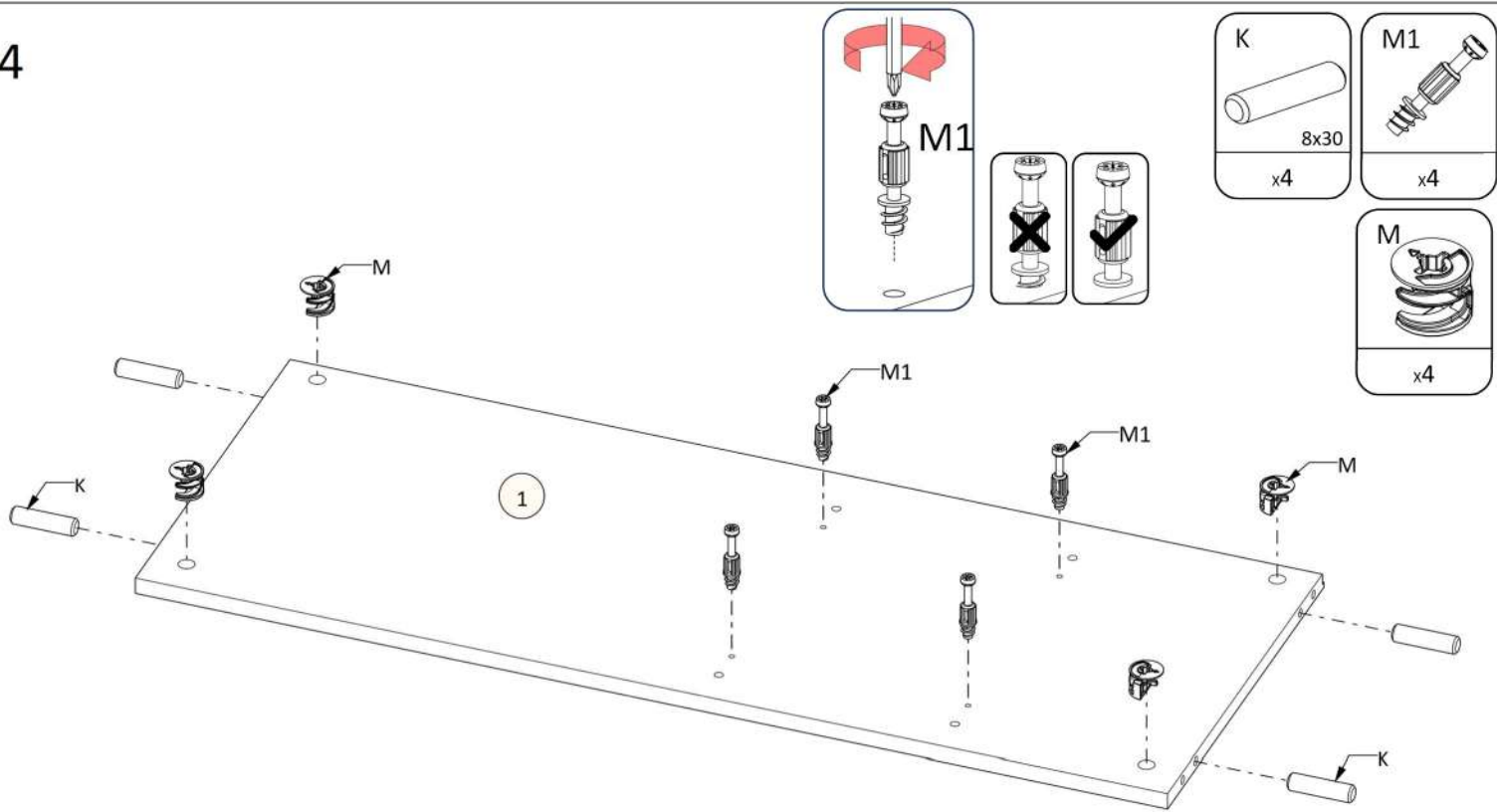

5

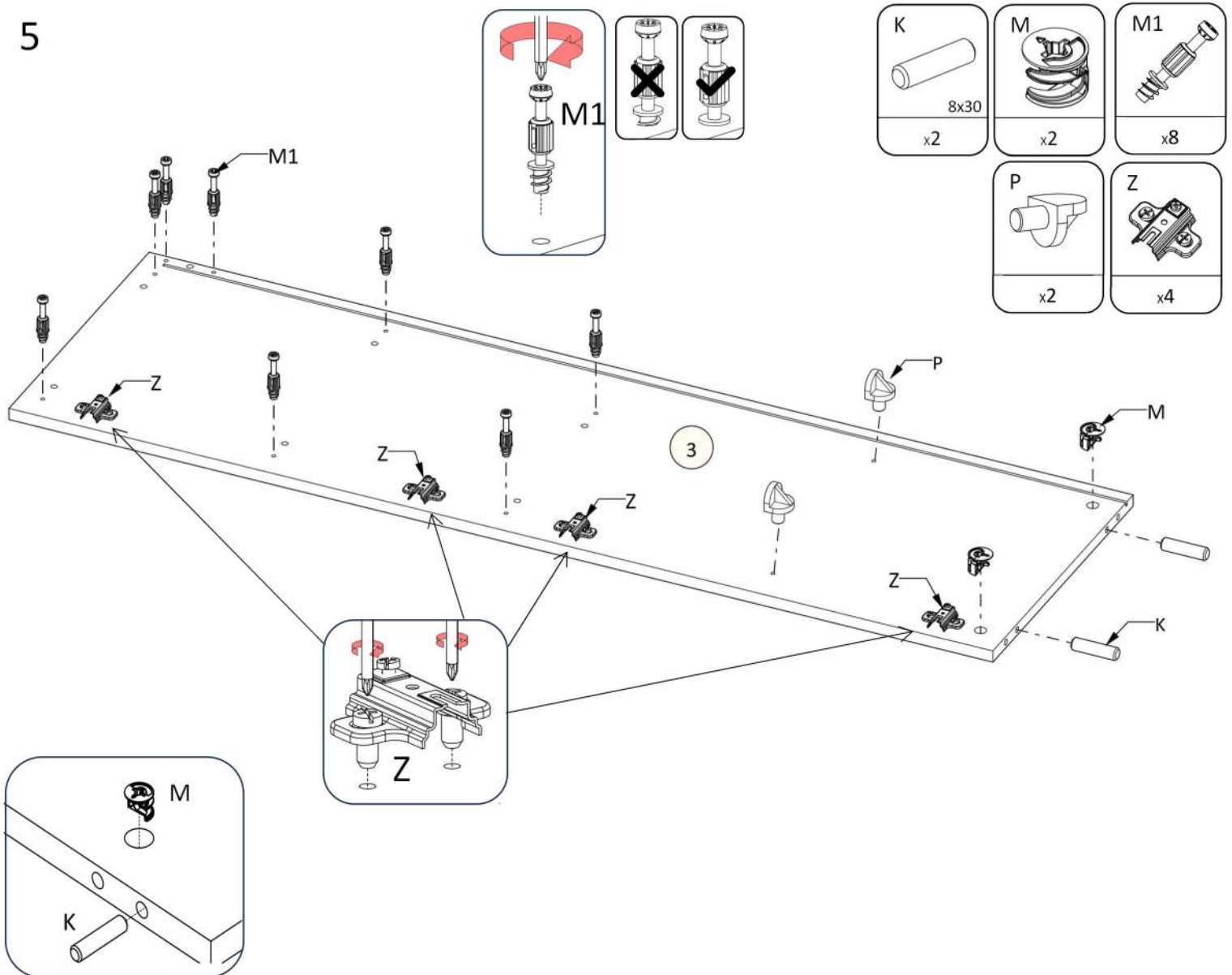

6

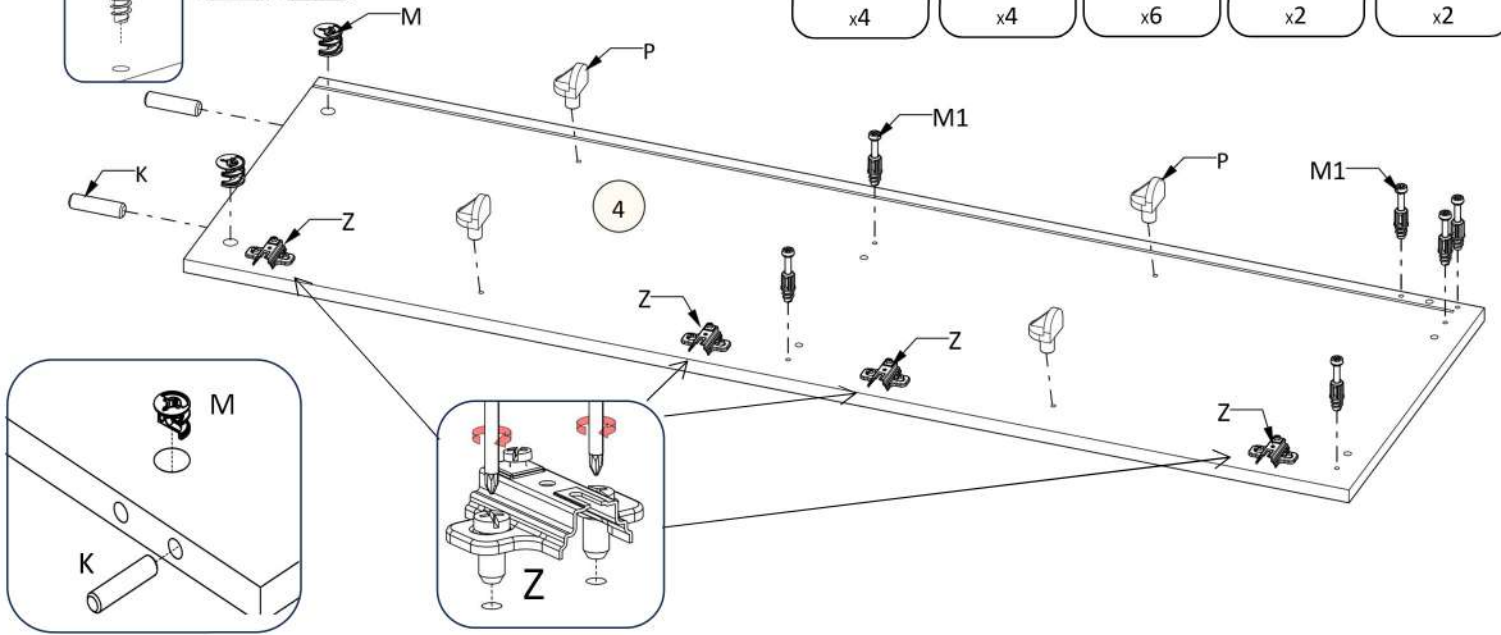
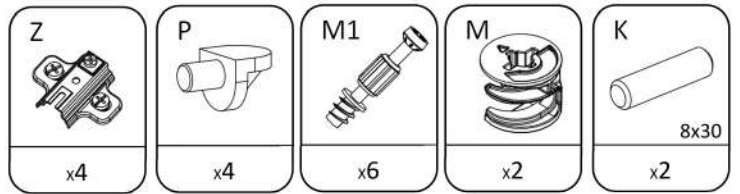
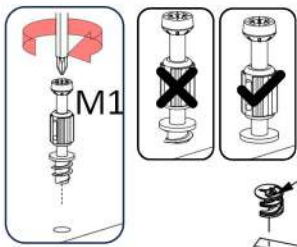

7

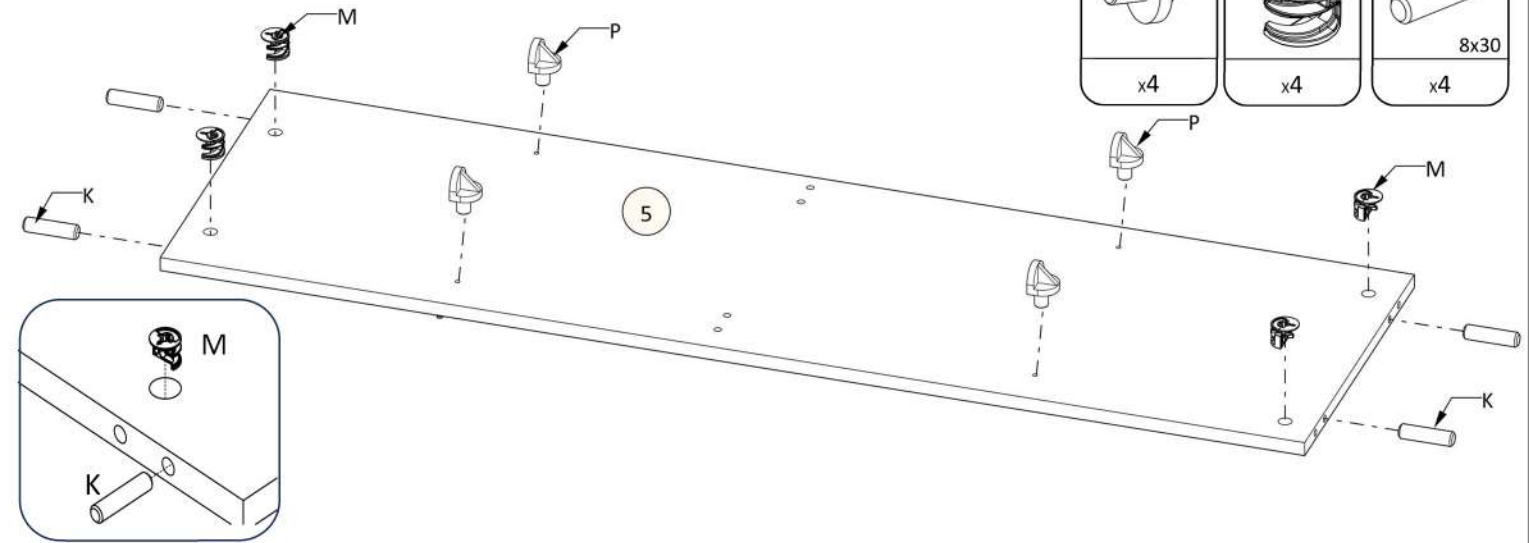
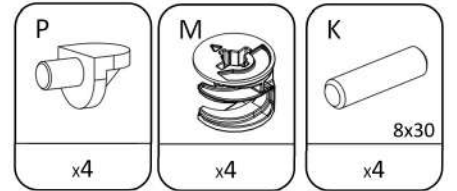

8

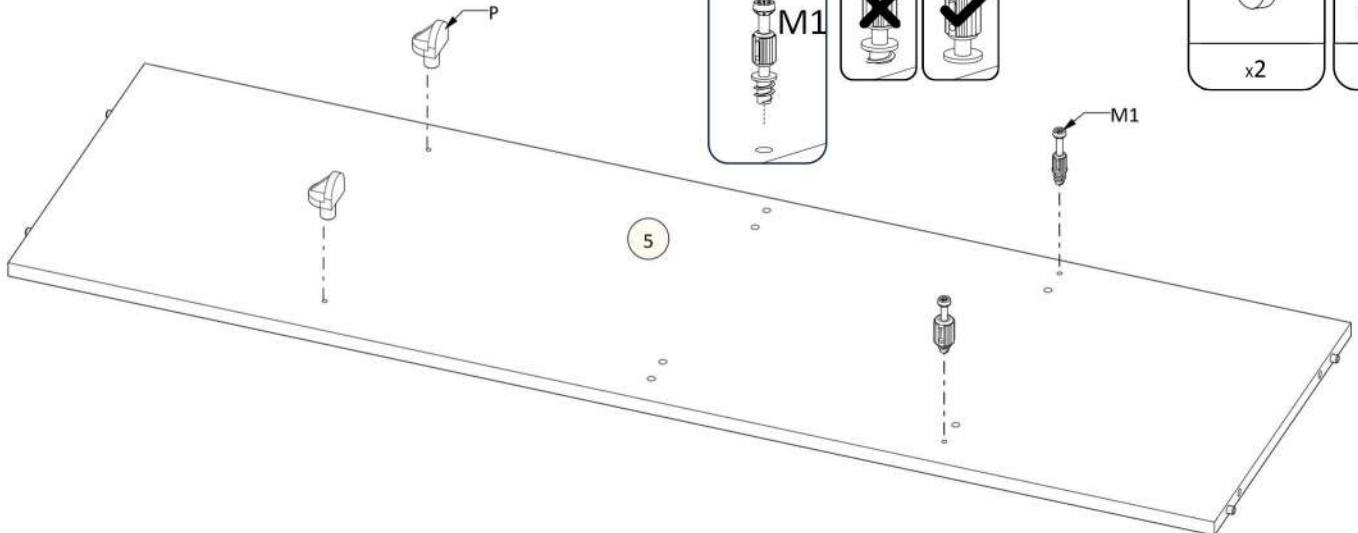
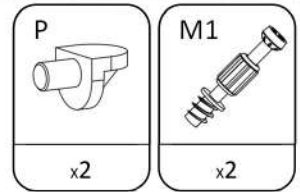
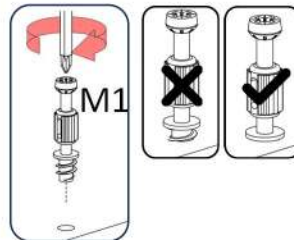

9

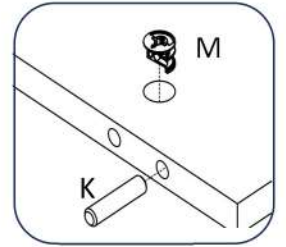
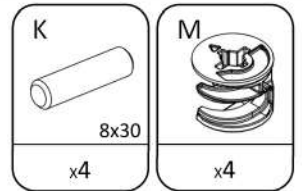
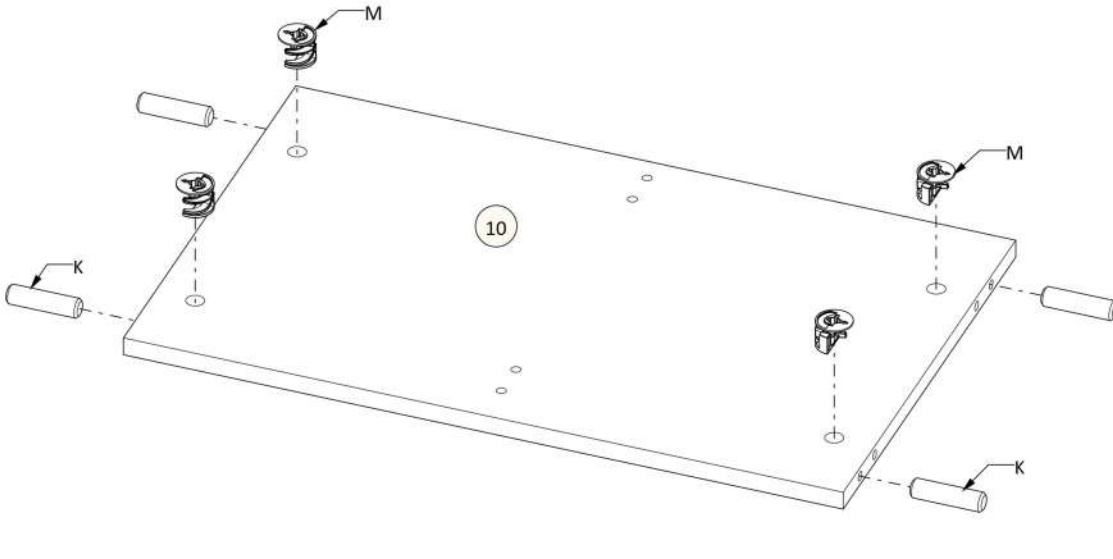

10

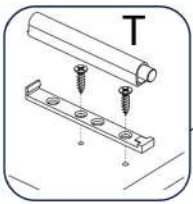
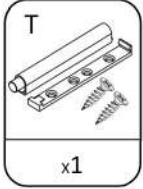
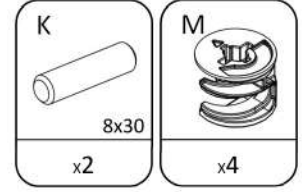
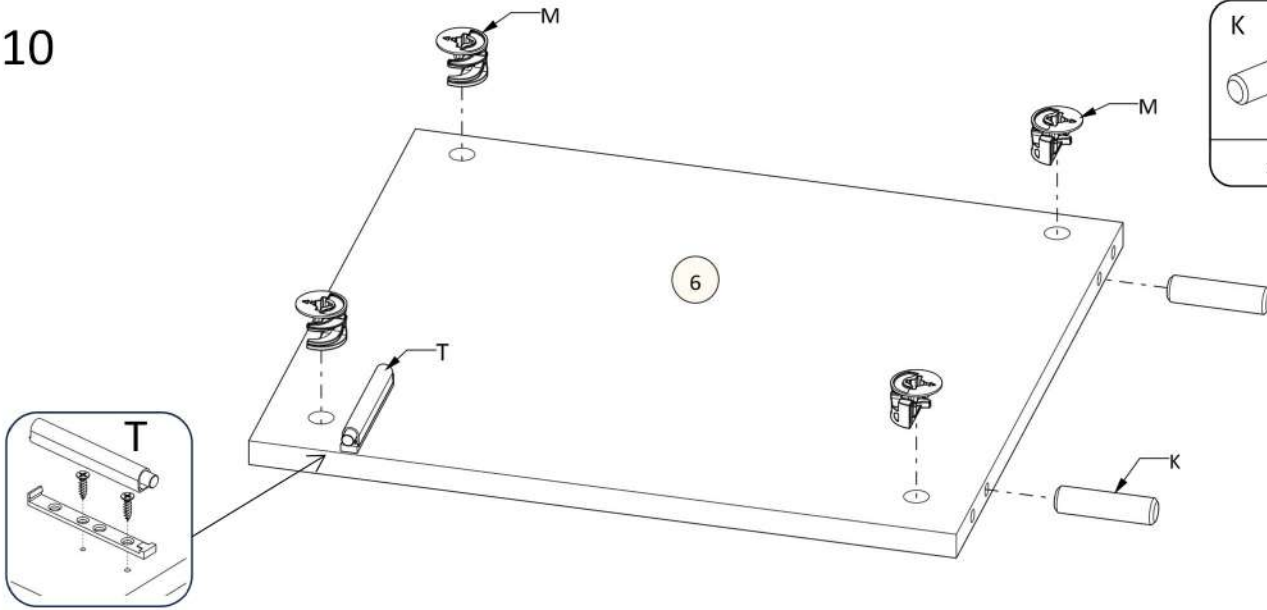

11

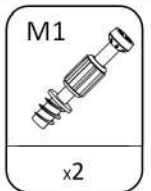
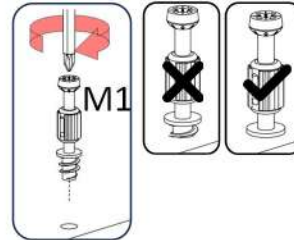
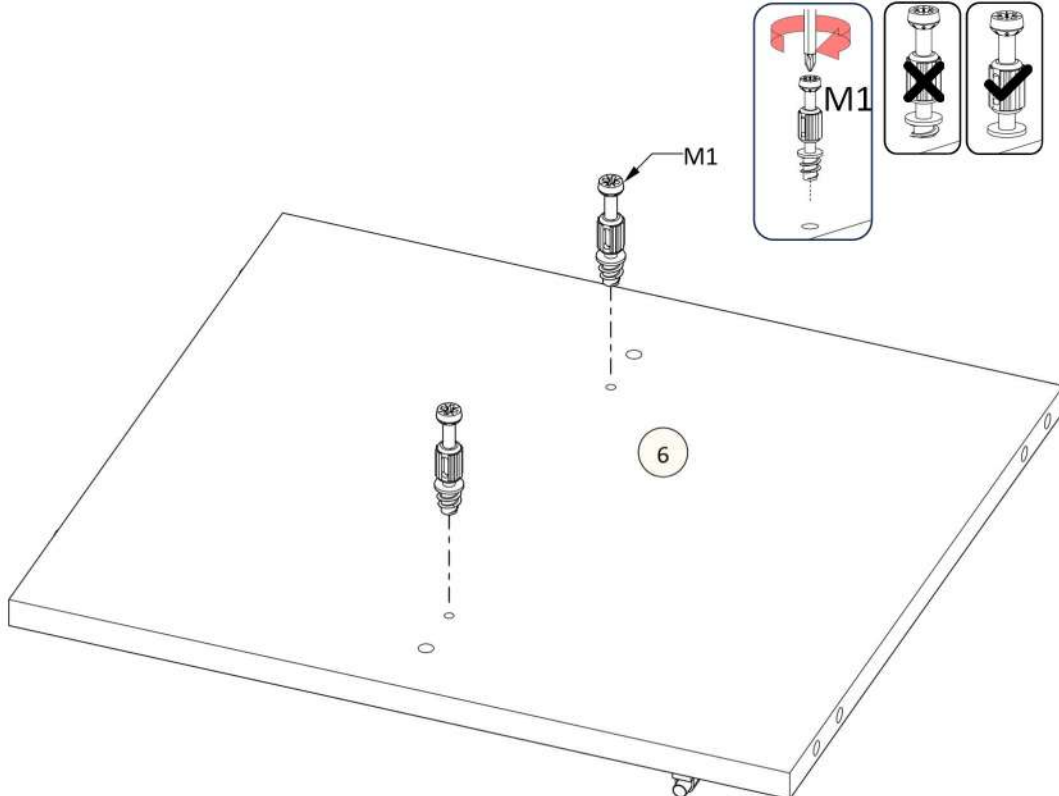

12

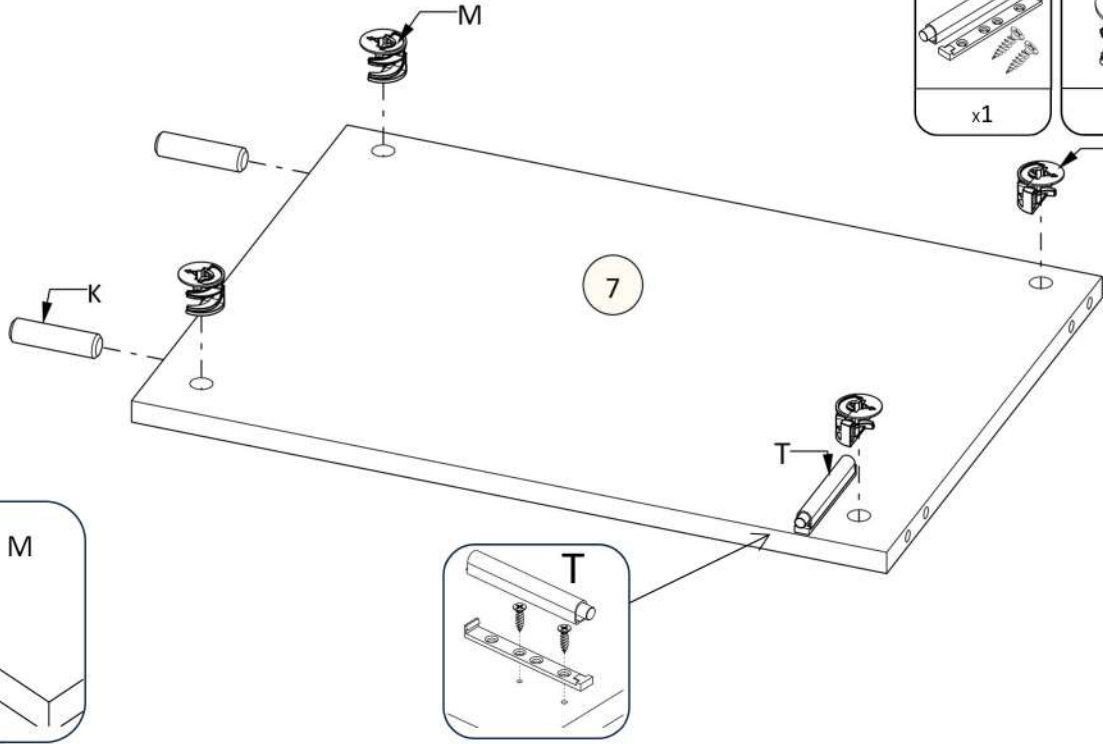

T	M	K
x1	x4	x2
		8x30

13

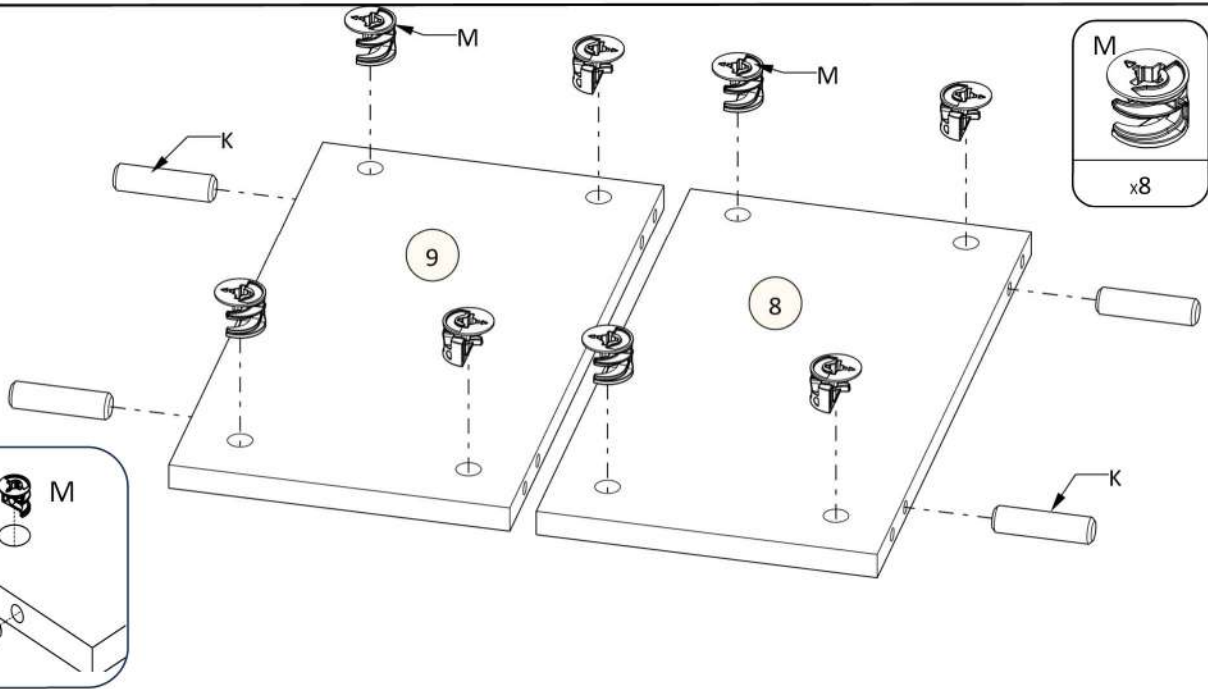

M	K
x8	x4
	8x30

14

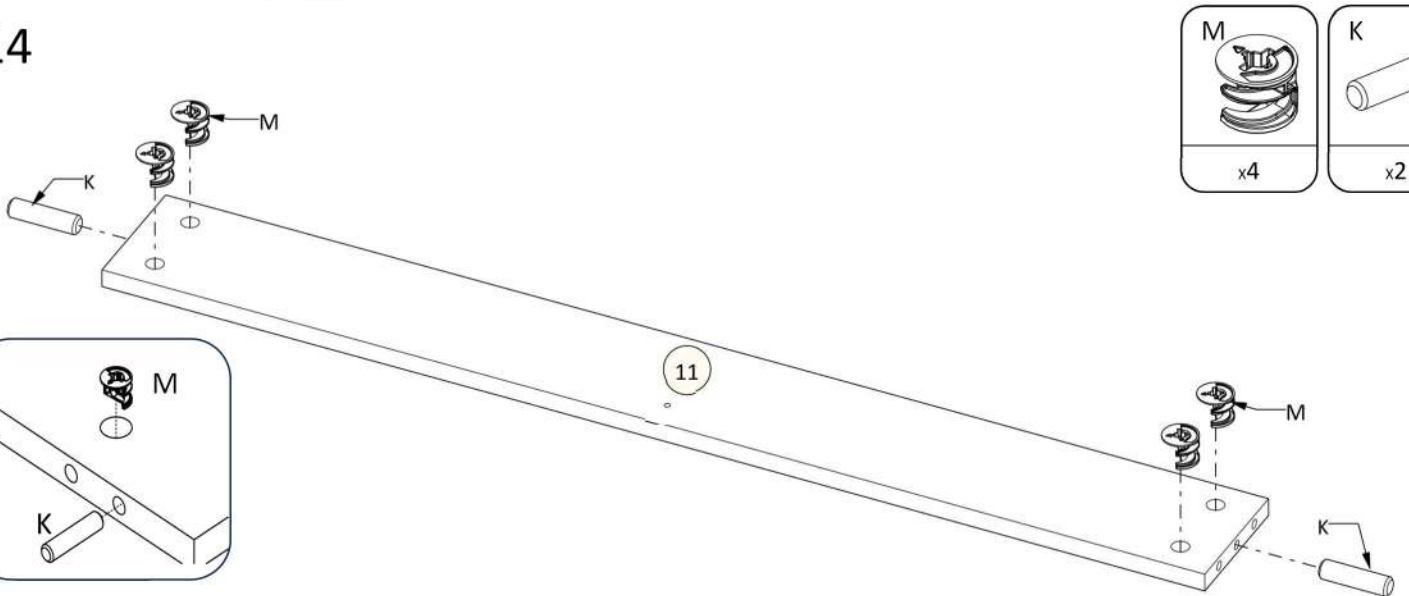

M	K
x4	x2
	8x30

15

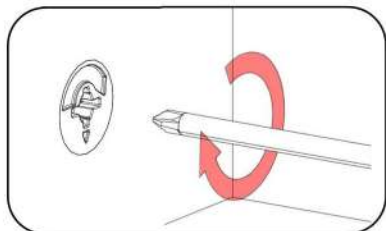
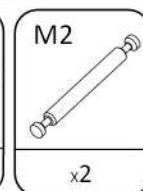
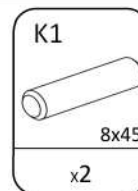
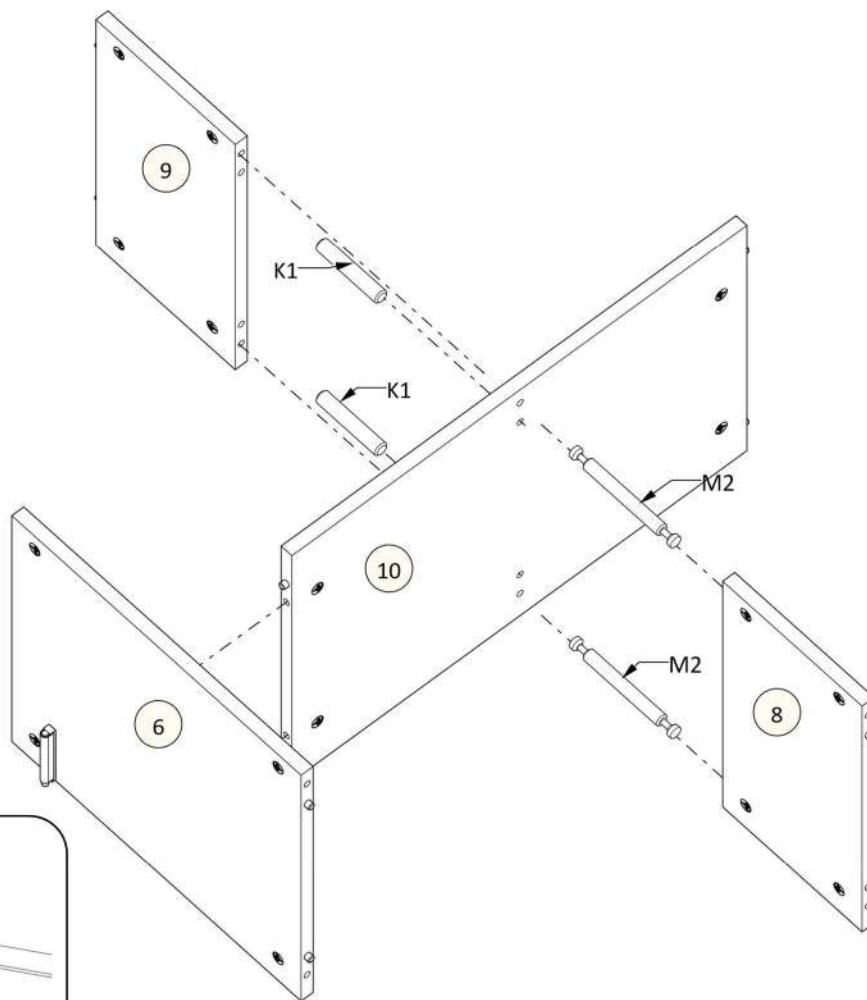

16

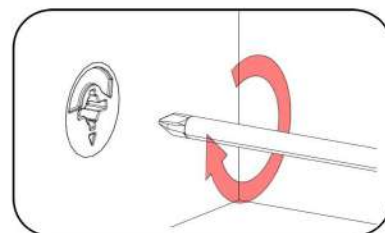
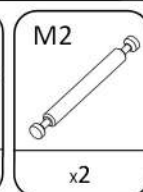
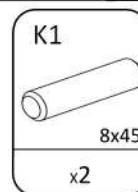
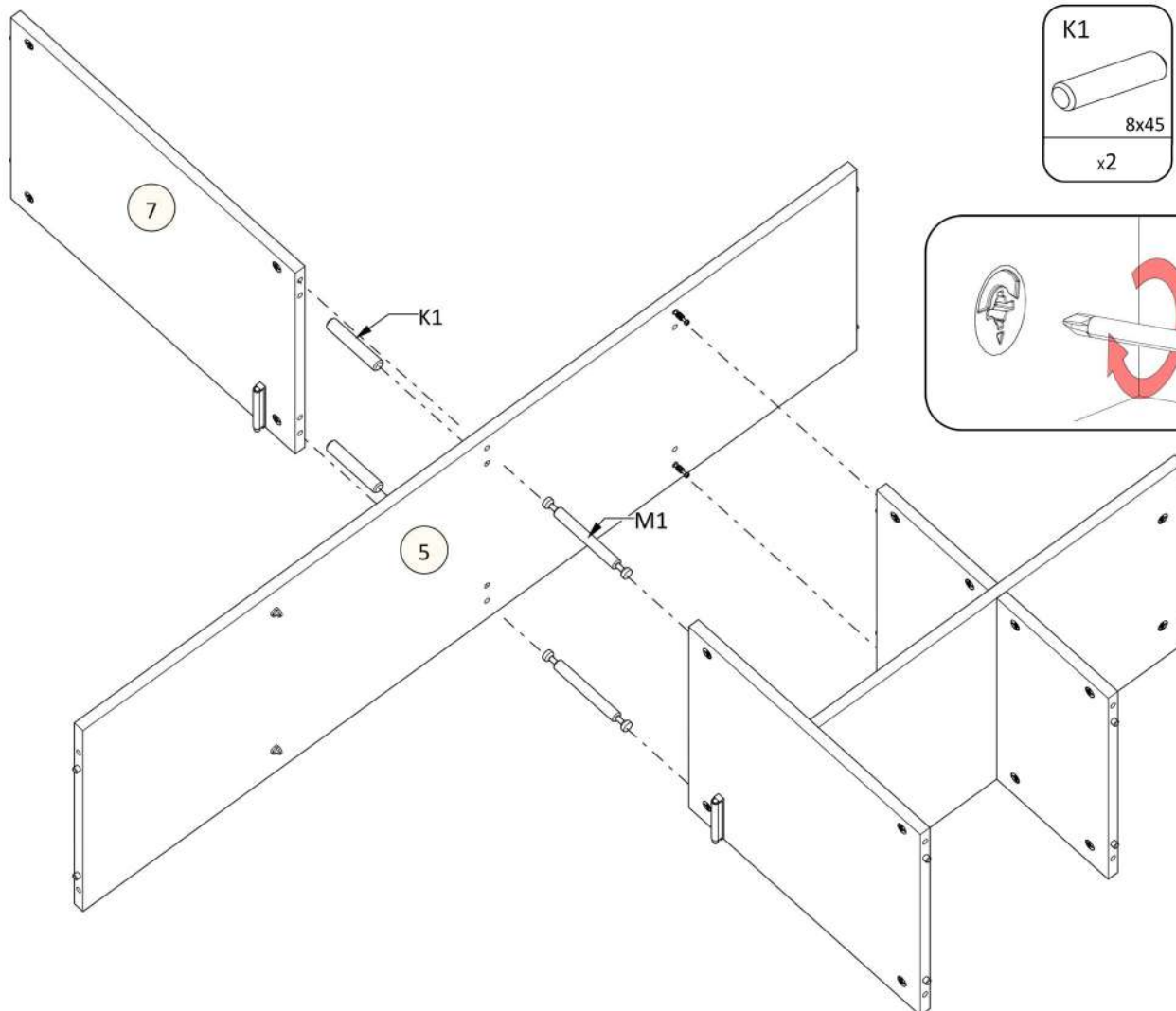

17

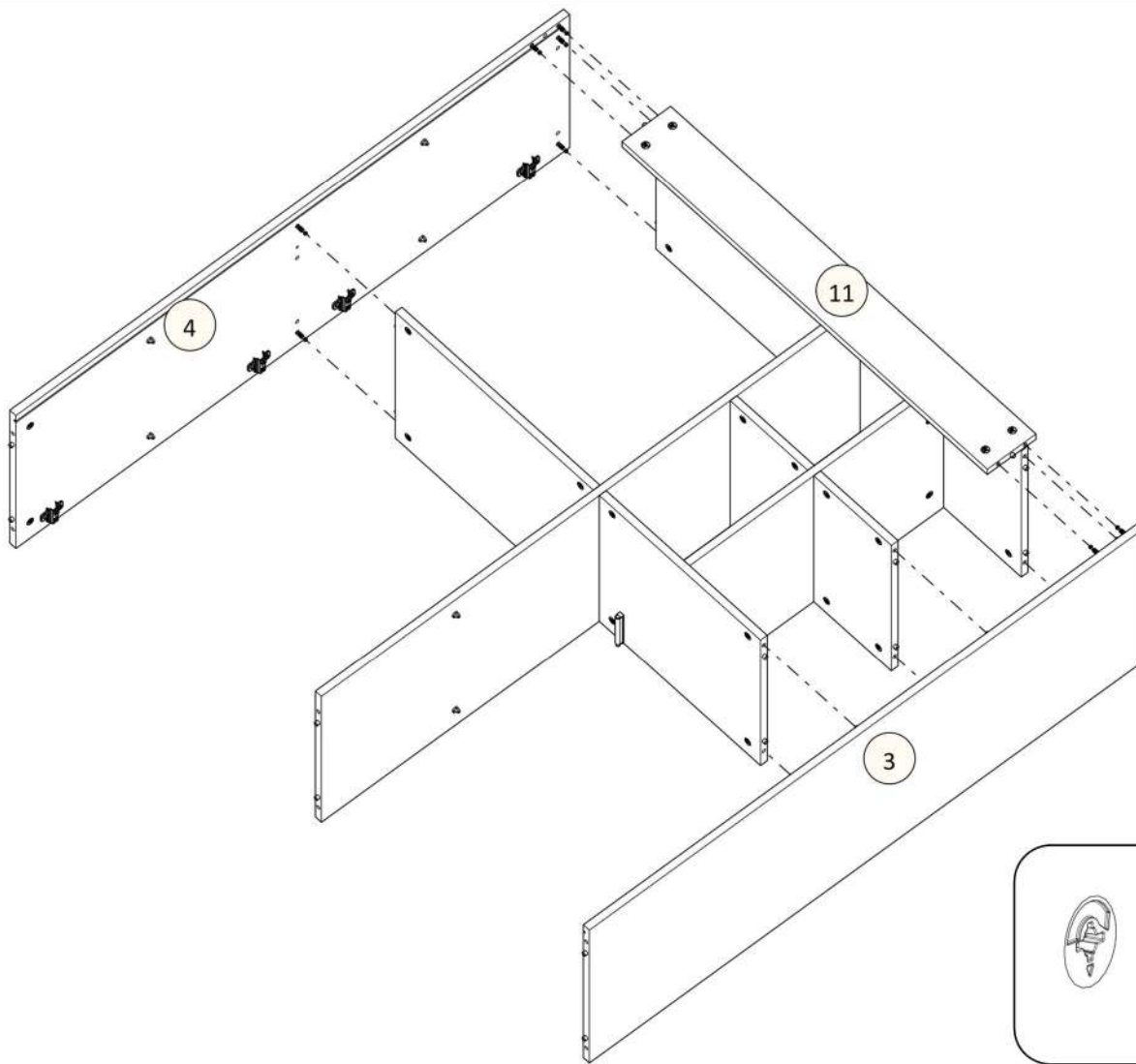

18

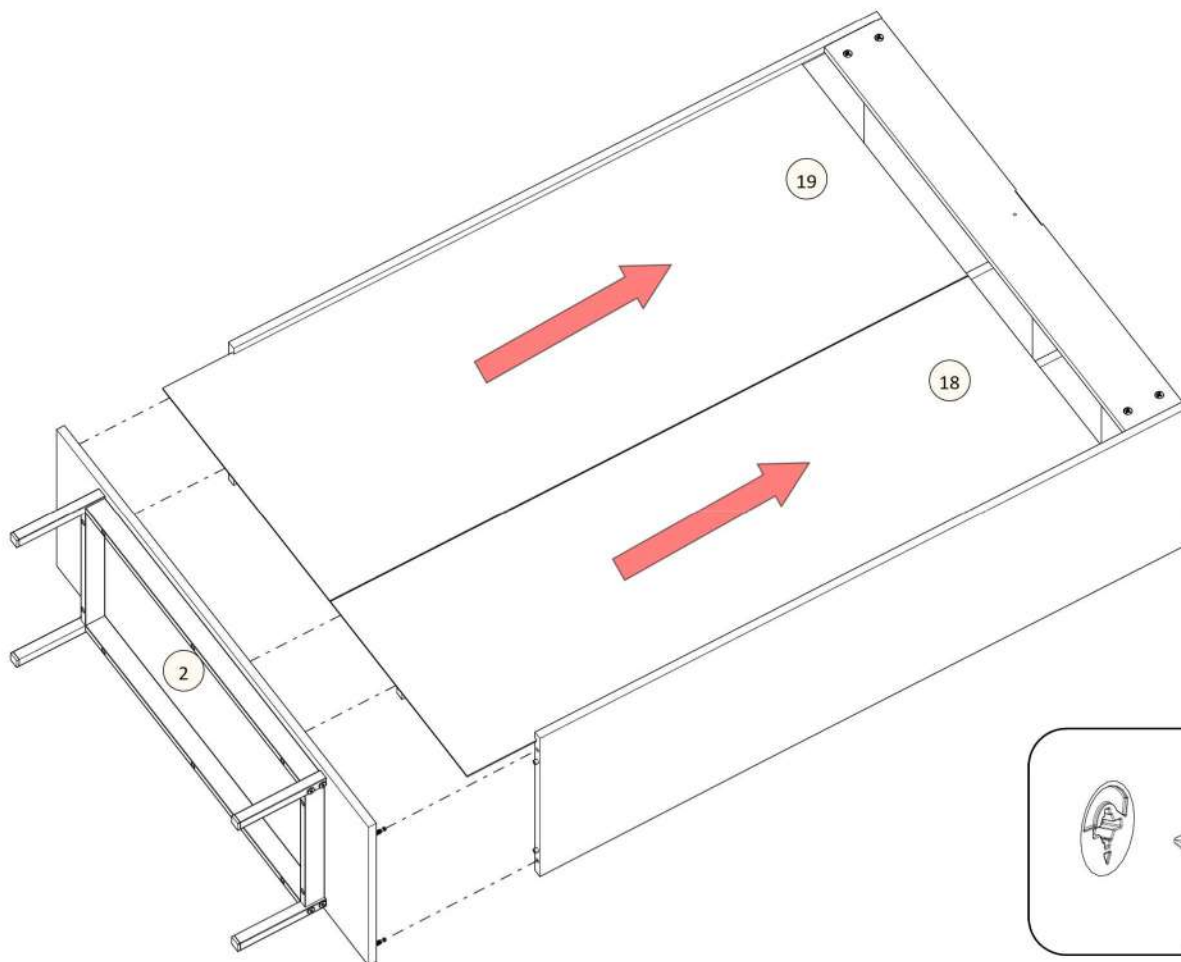

21

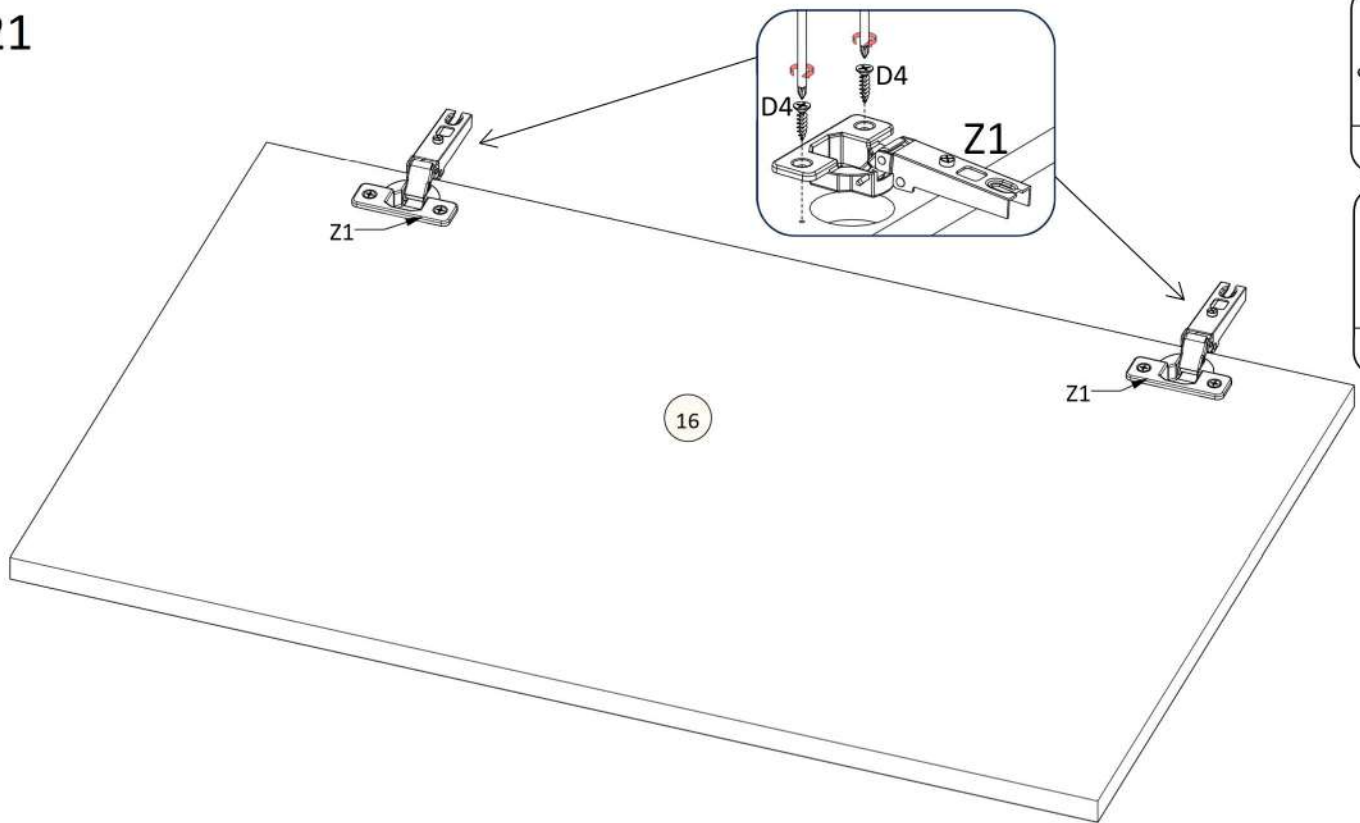

22

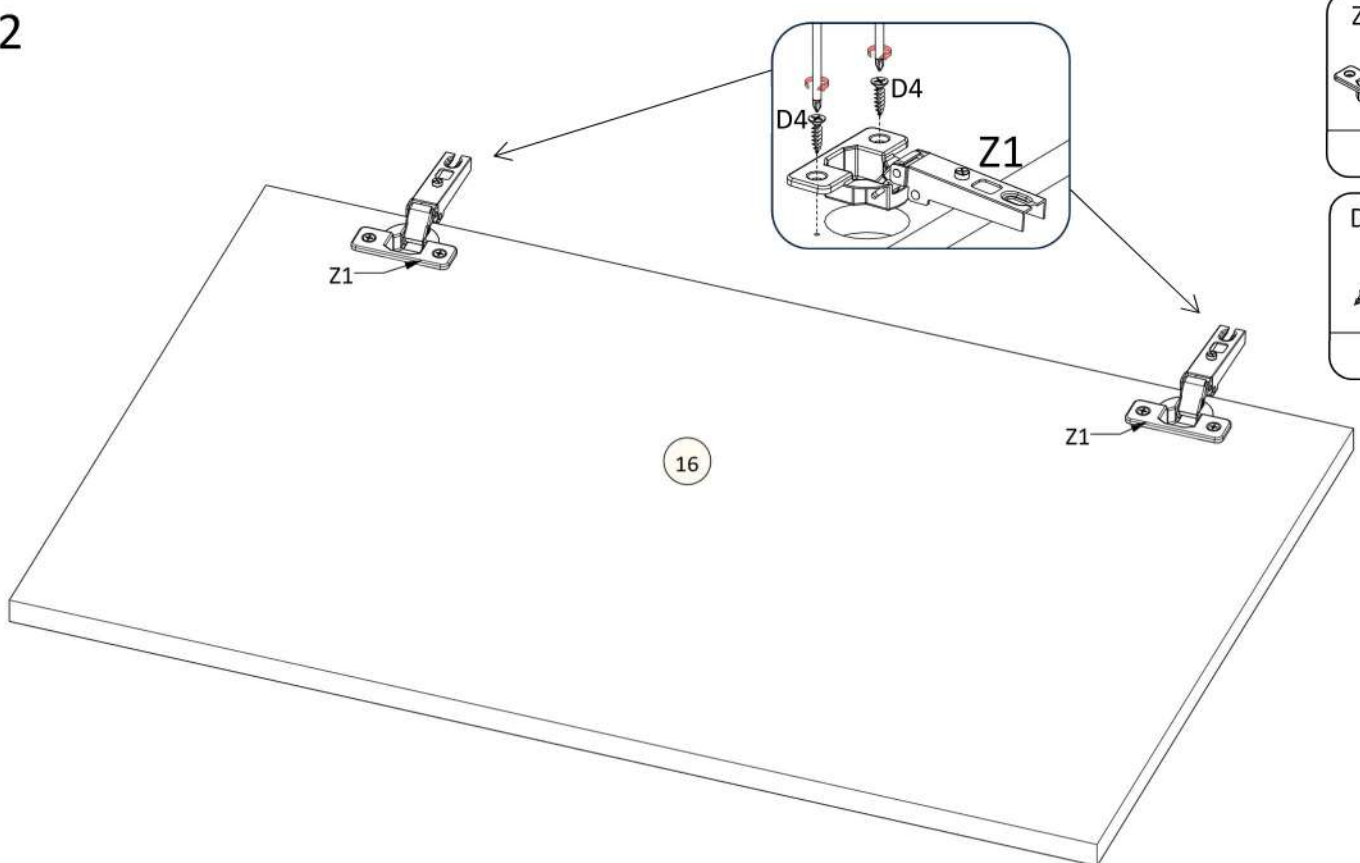

23

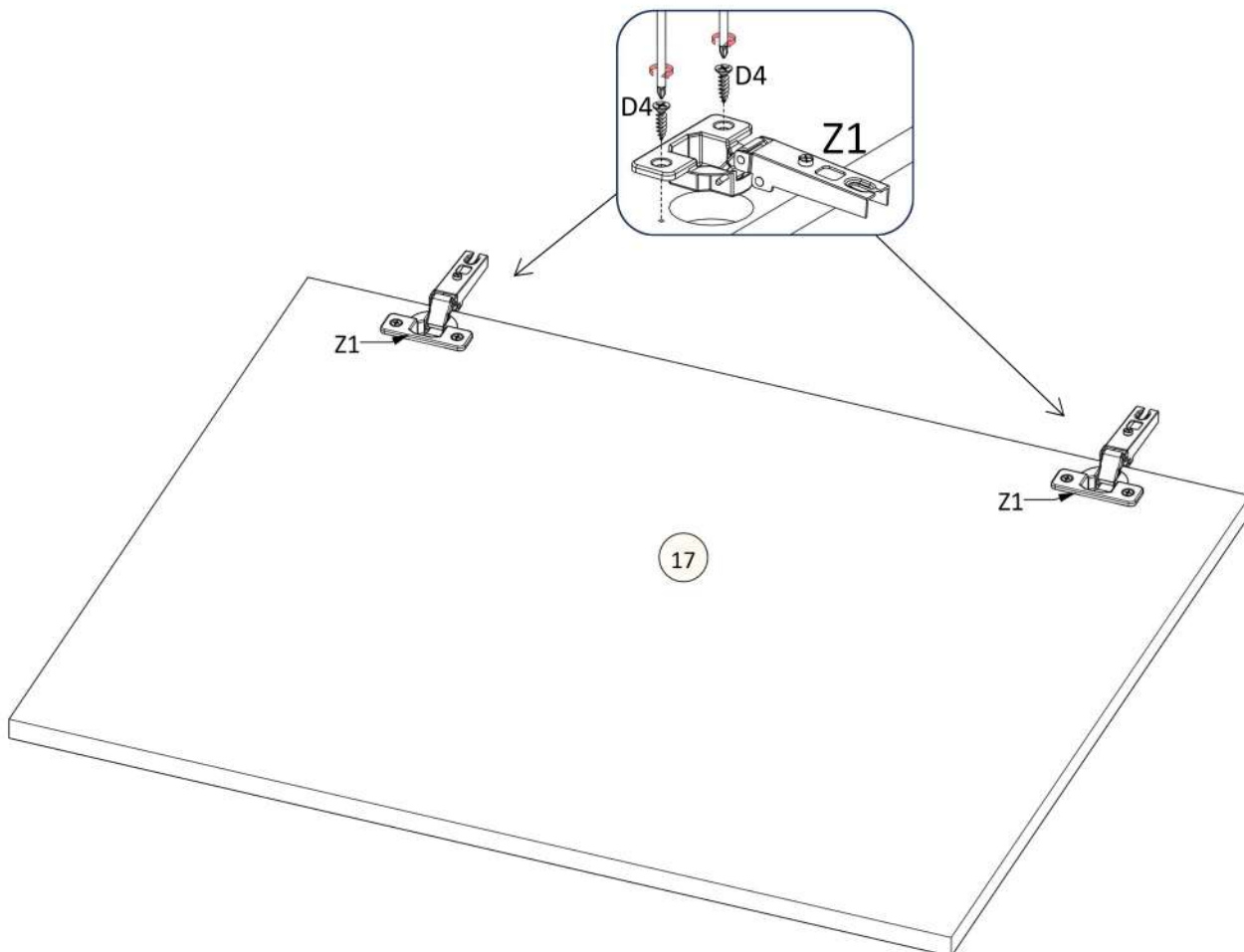
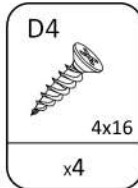
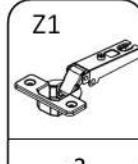

24

