

# BALSI

## Witryna 1W

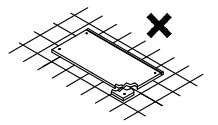

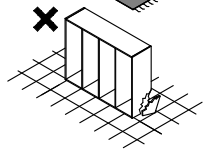
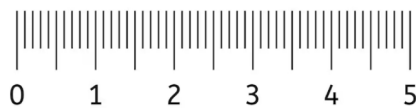
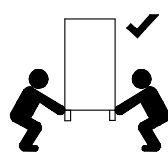
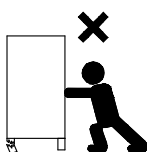
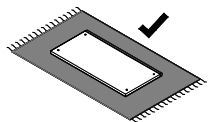
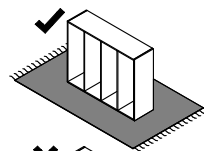
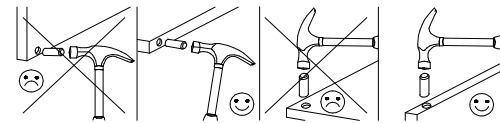
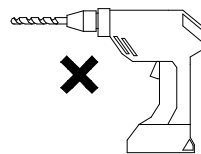
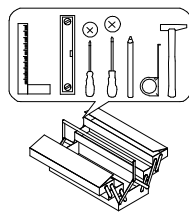
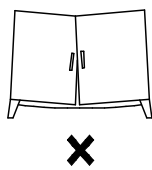
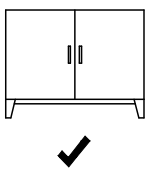
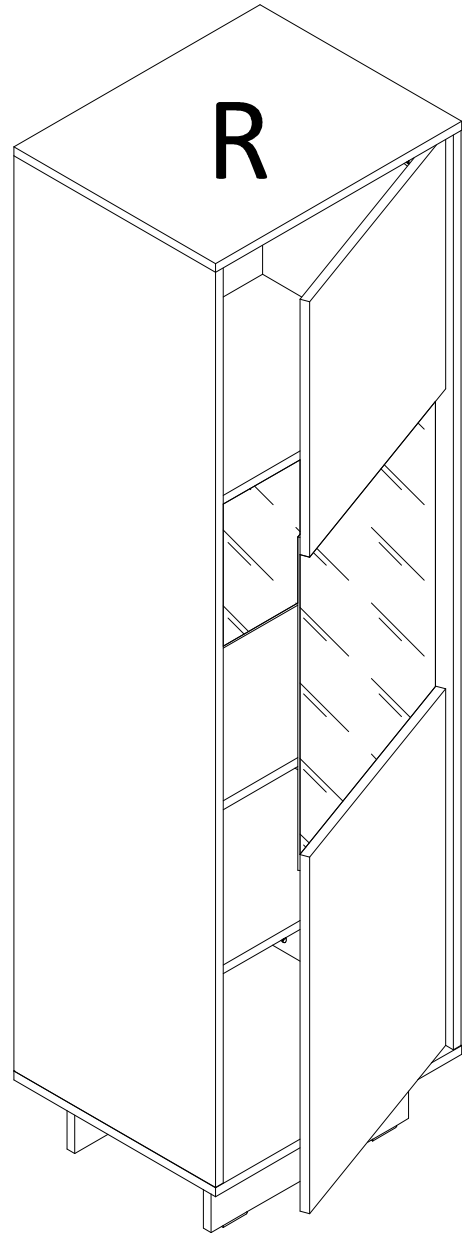
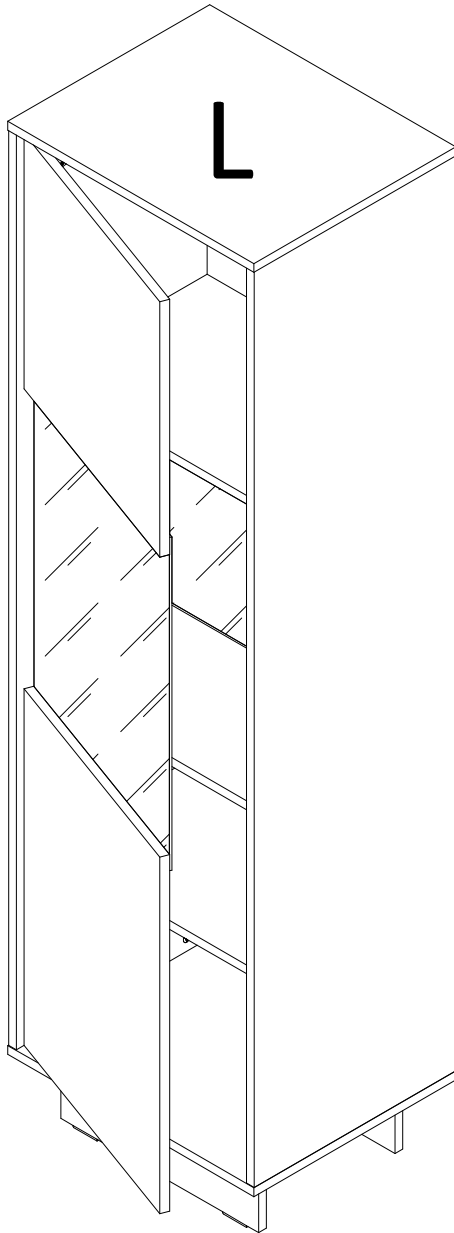
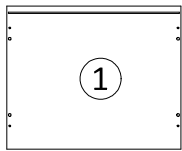

512x420

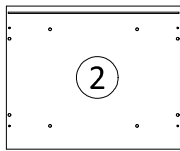

512x420

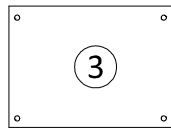

479x357

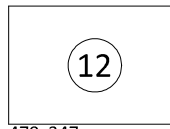

479x347

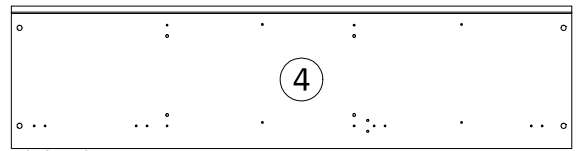

1648x419

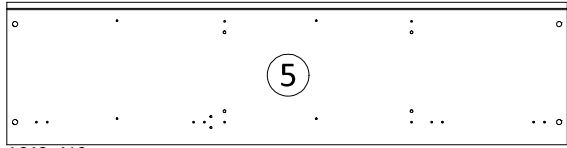

1648x419

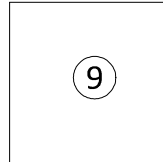

473x460

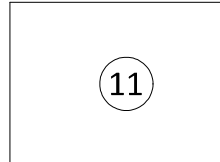

473x642

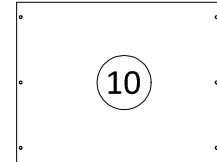

600x471x4

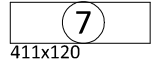

411x120

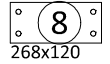

268x120

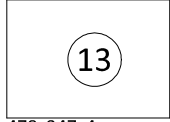

478x347x4

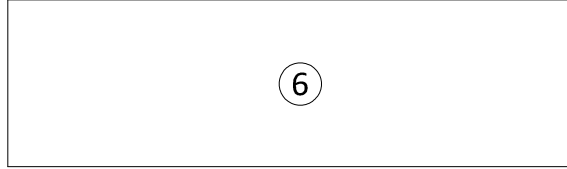

1657x487

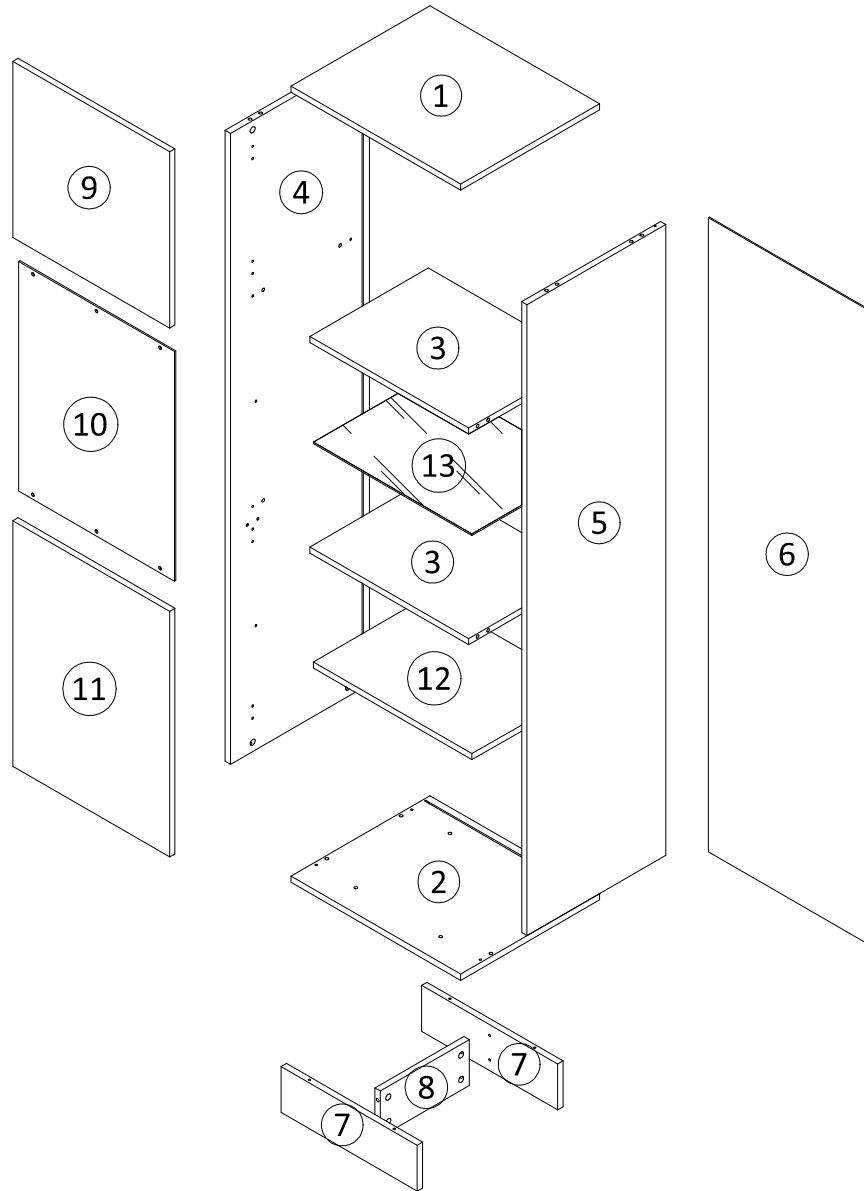

2x	1x	4x	12x	6x	16x	20x	20x	4x	4x
6x	6x	4x	4x	4x	20x	10x	8x	1x	4x

# 1

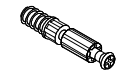
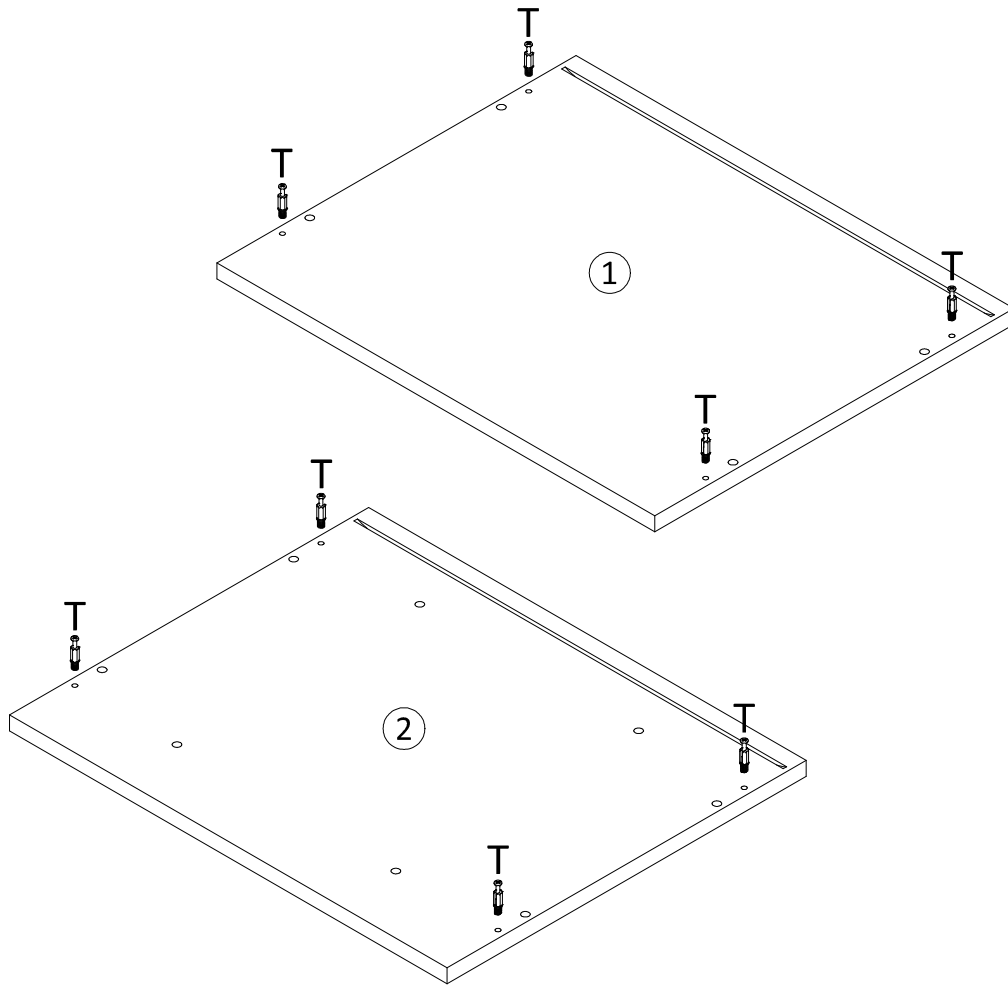

T

8x

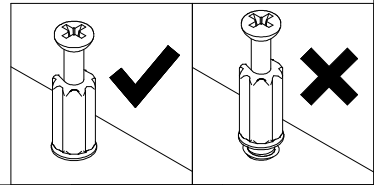

# 2

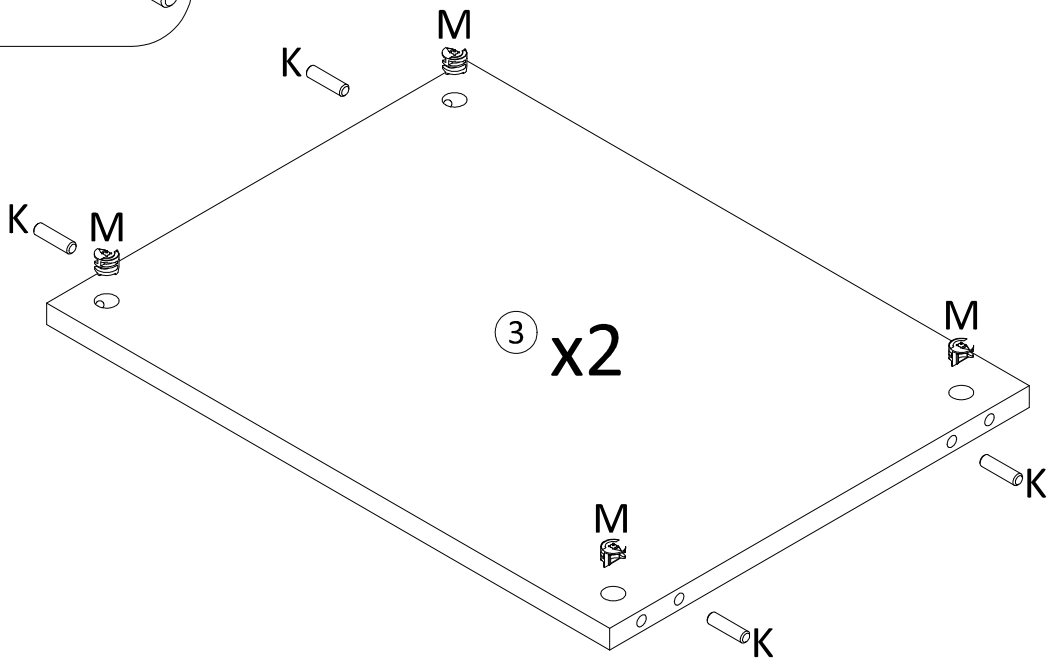
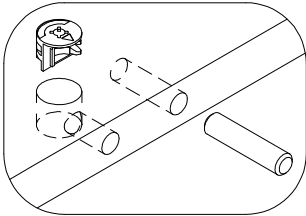

M

8x

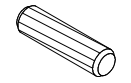

K

8x

# 3

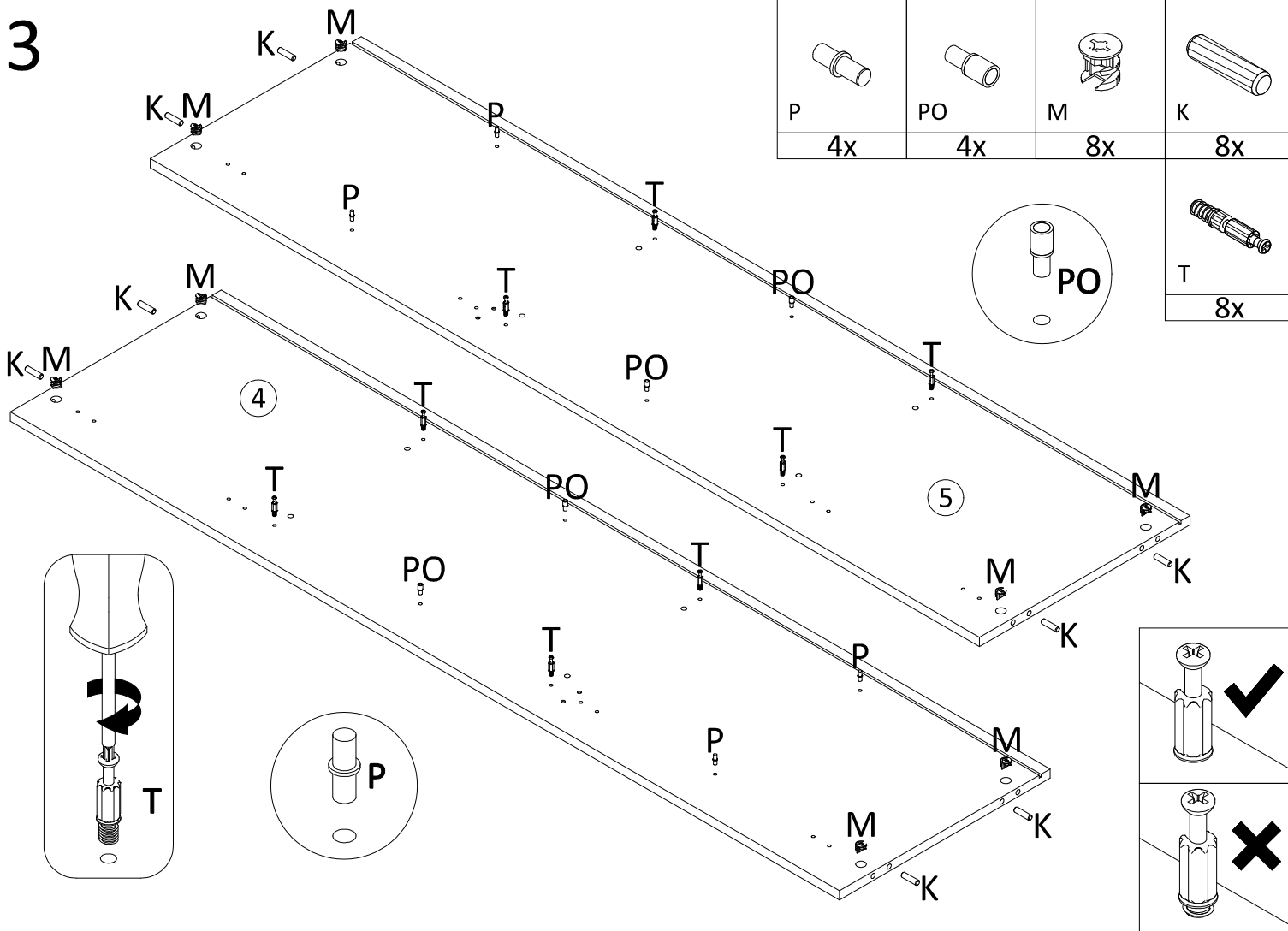

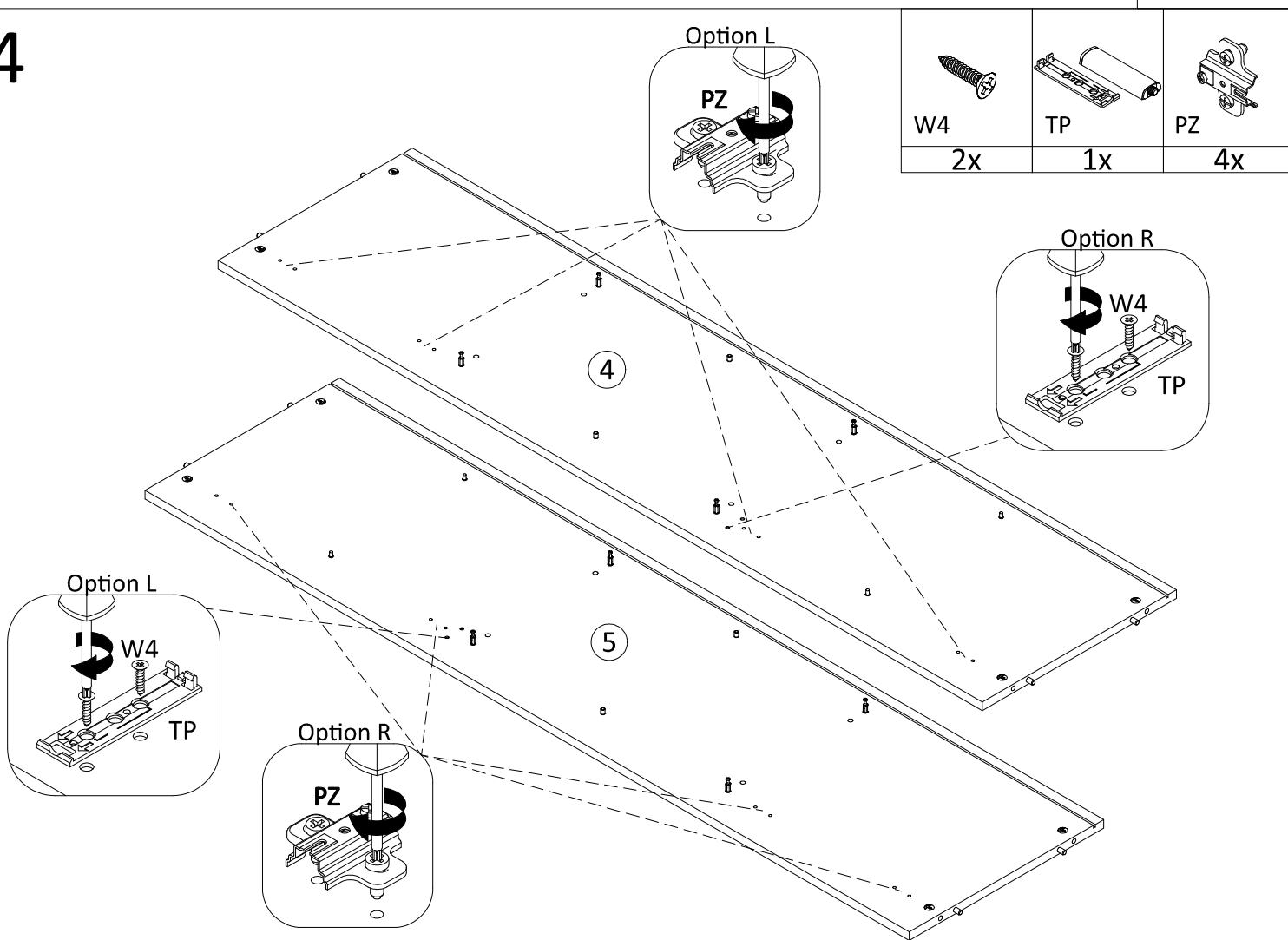

# 4

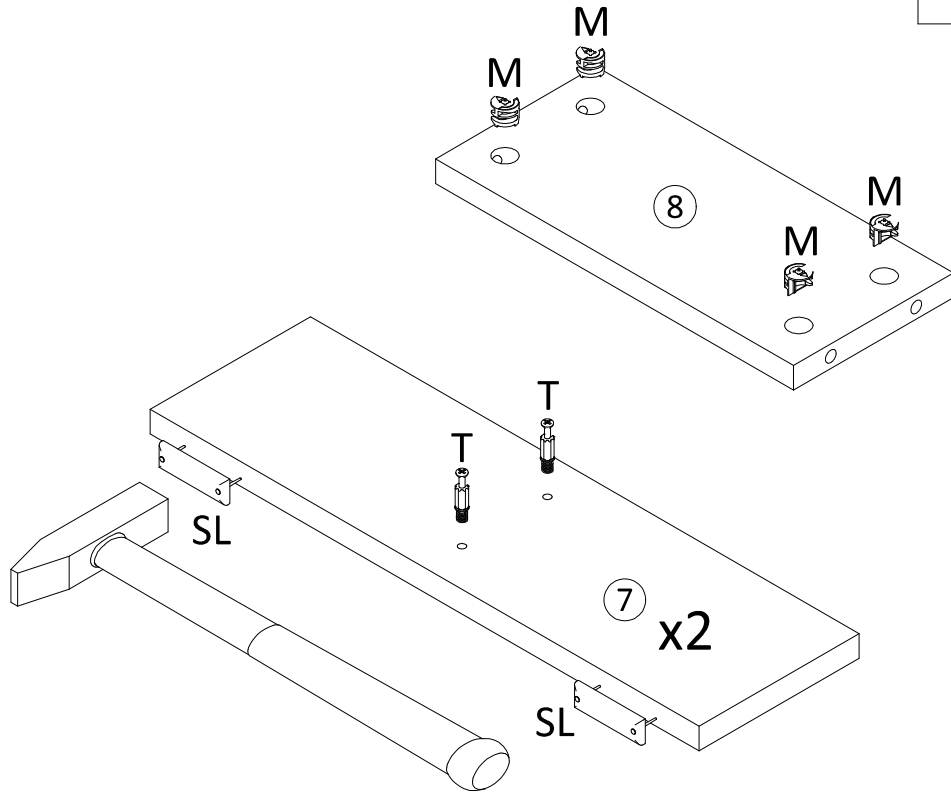

5

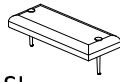
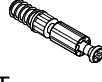

 SL	 T	 M
4x	4x	4x

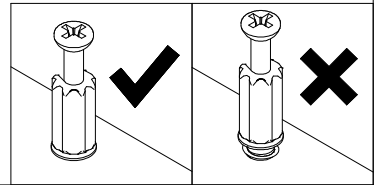
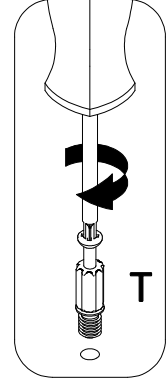

6

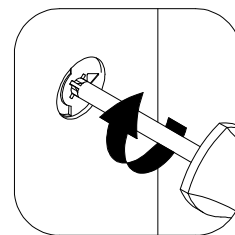
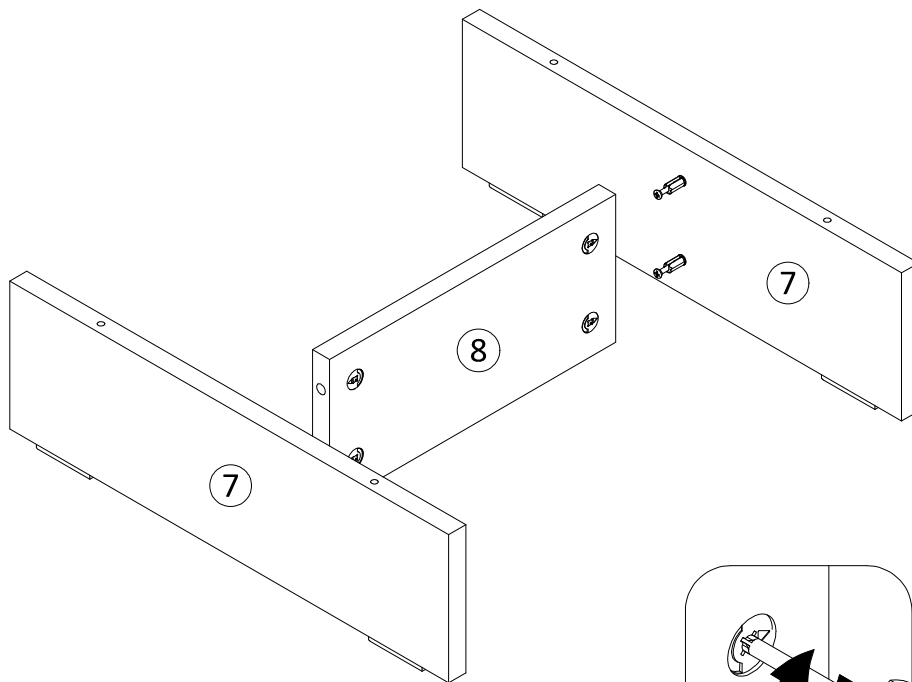

# 7

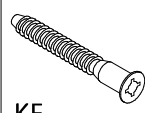
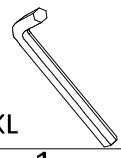
	
KF	KL
4x	1x

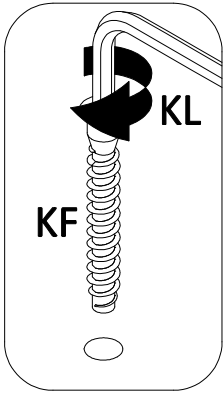
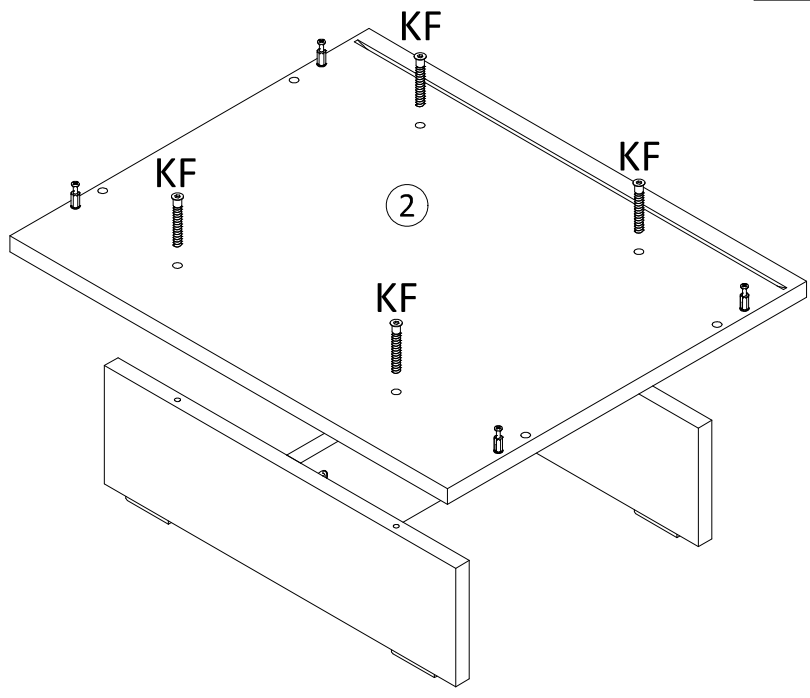

# 8

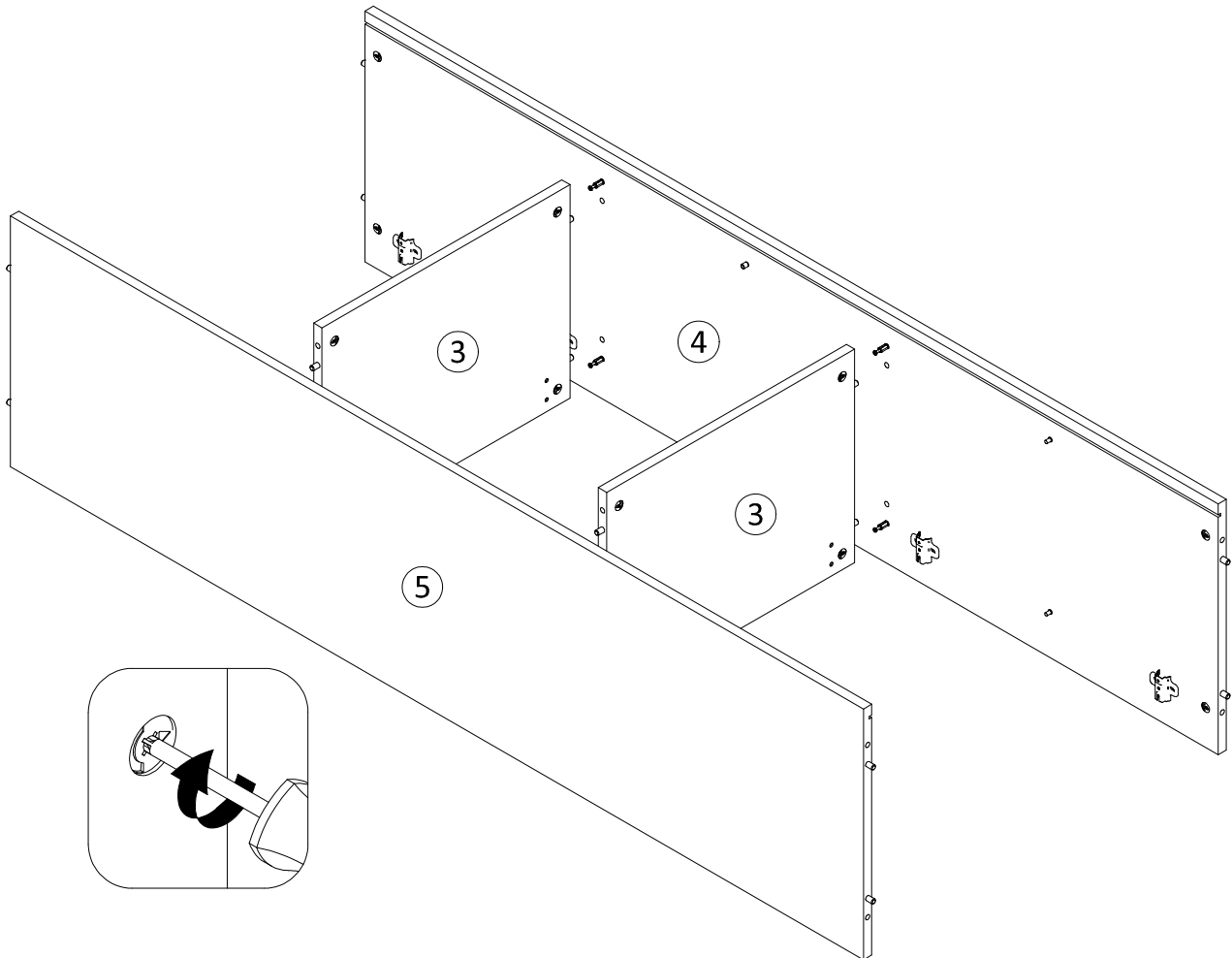

9

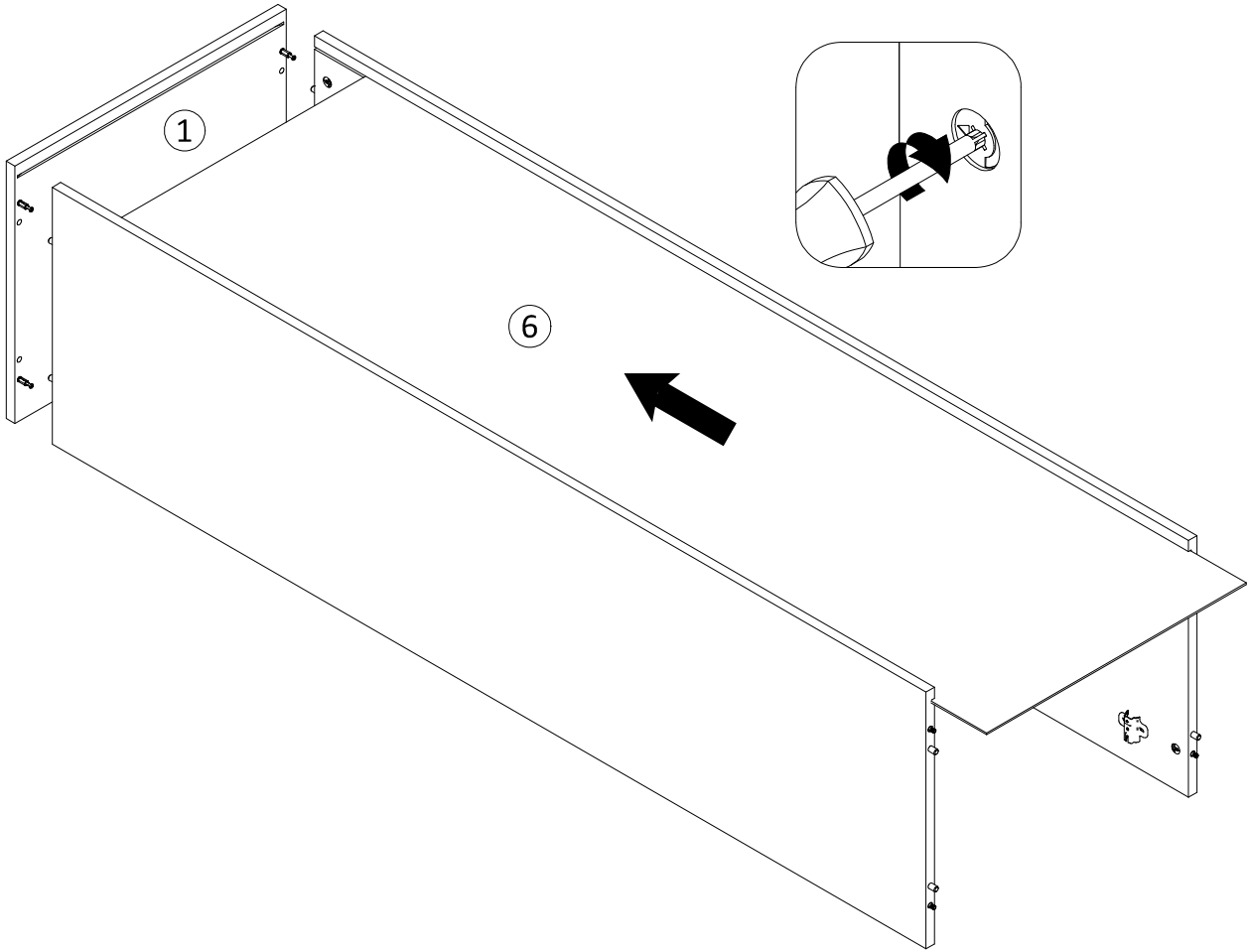

10

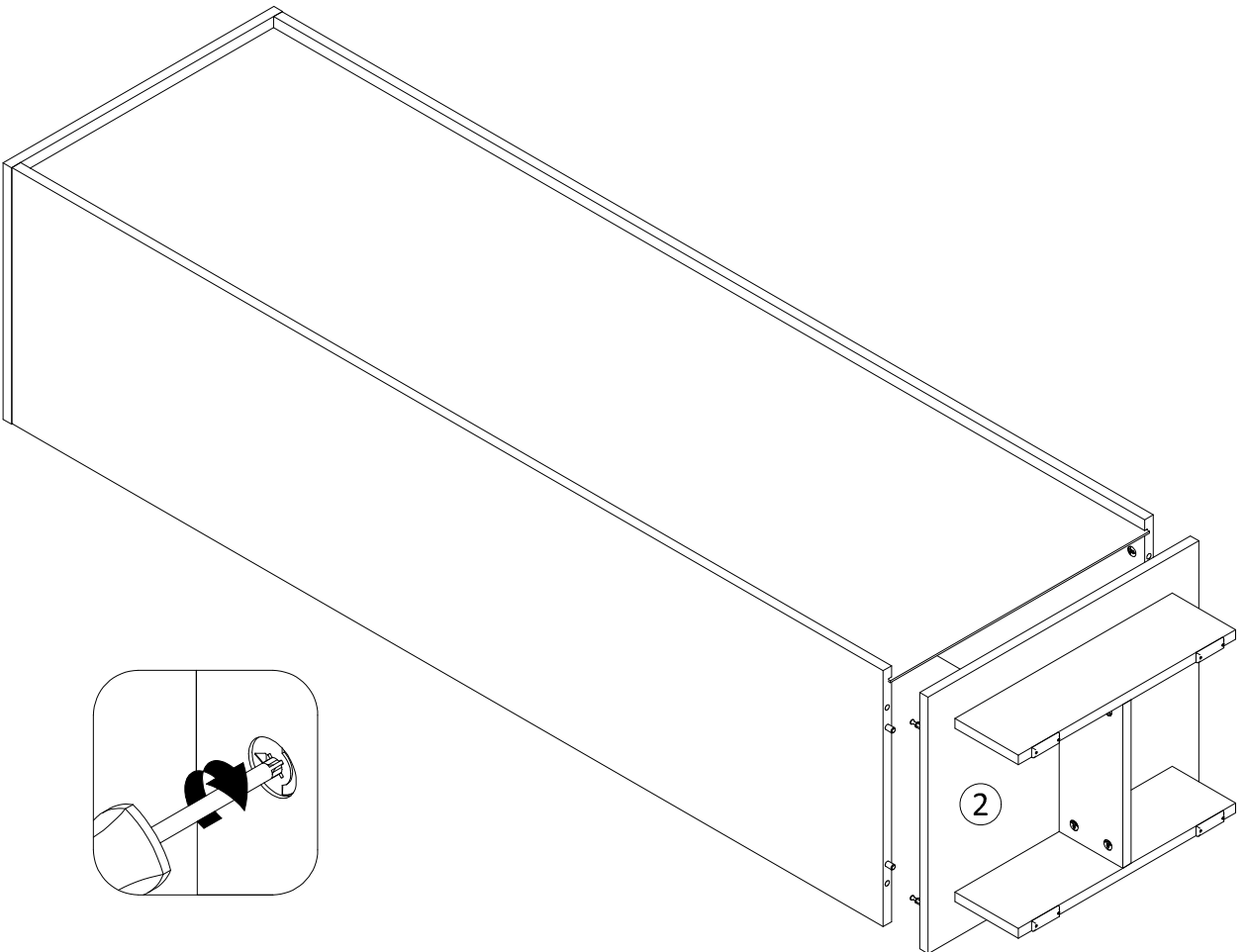

# 11

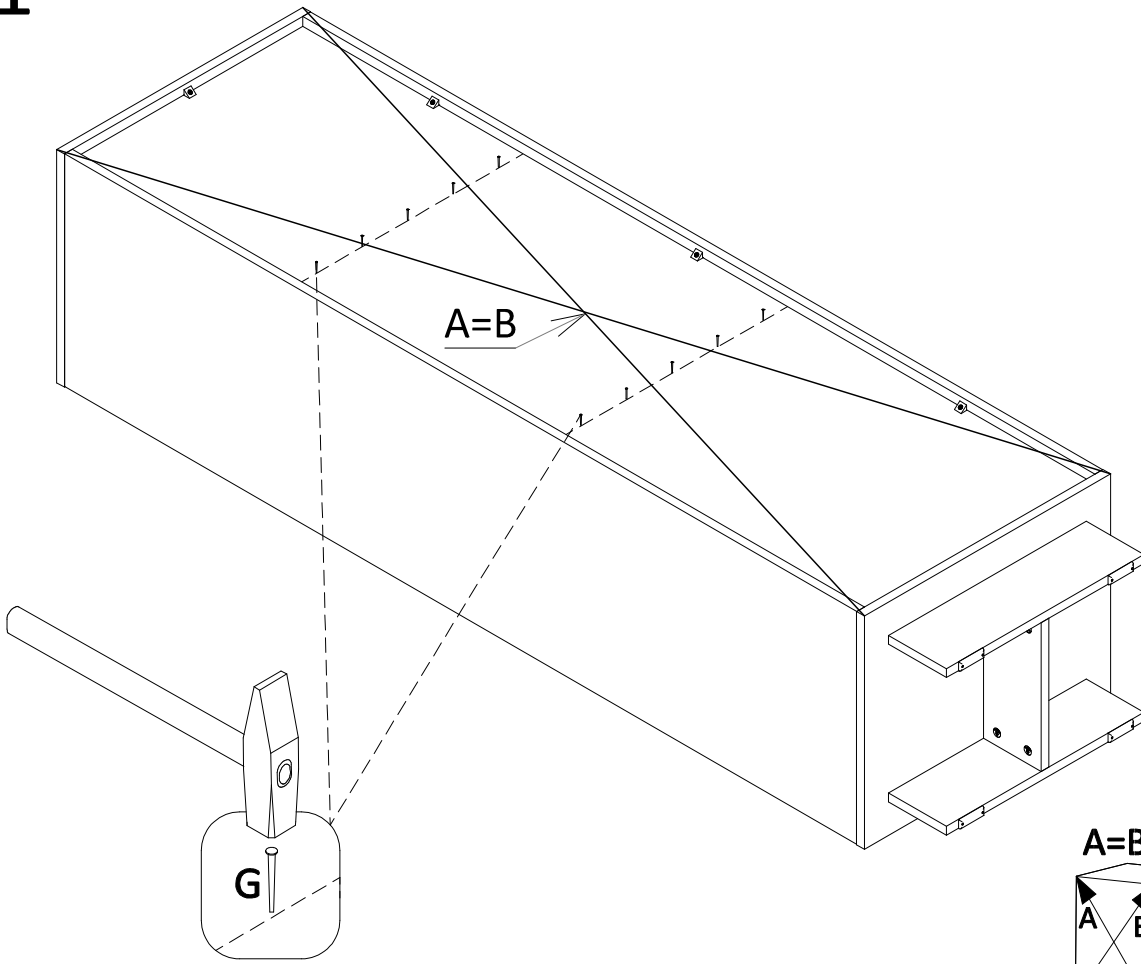

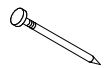
	
S	G
8x	10x

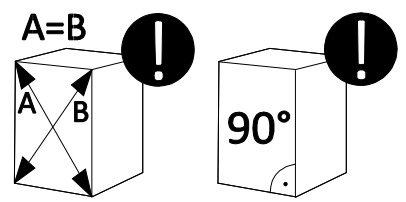
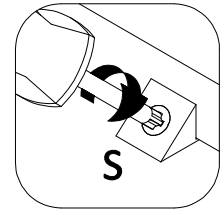

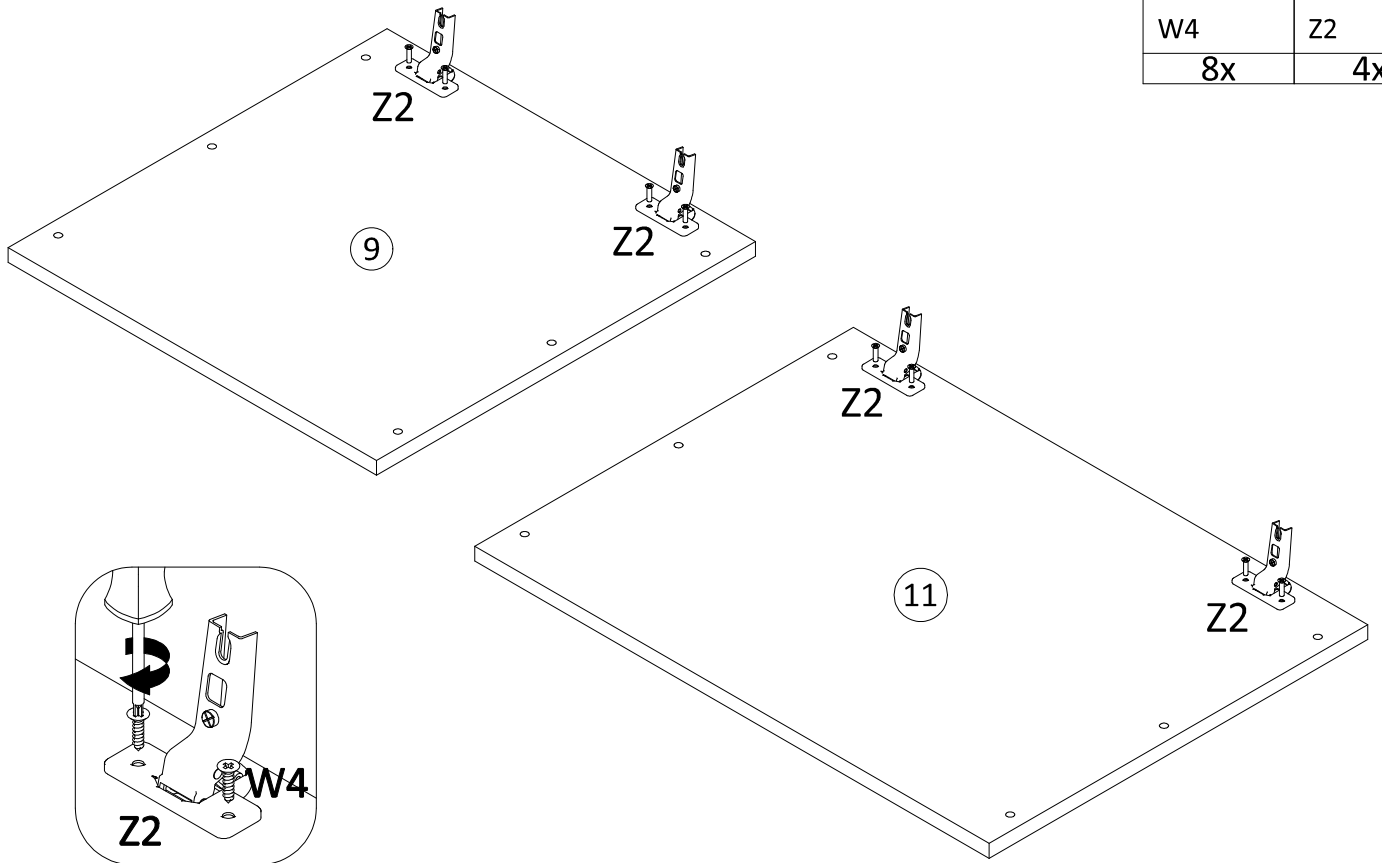

# 12

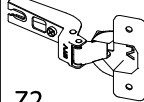

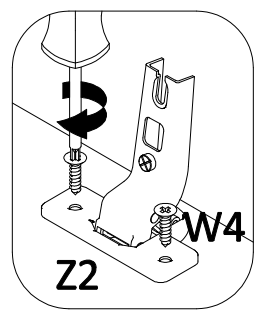
	
W4	Z2
8x	4x

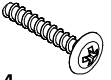

# 13 Option L

		
MF	TL	S4
6x	6x	6x

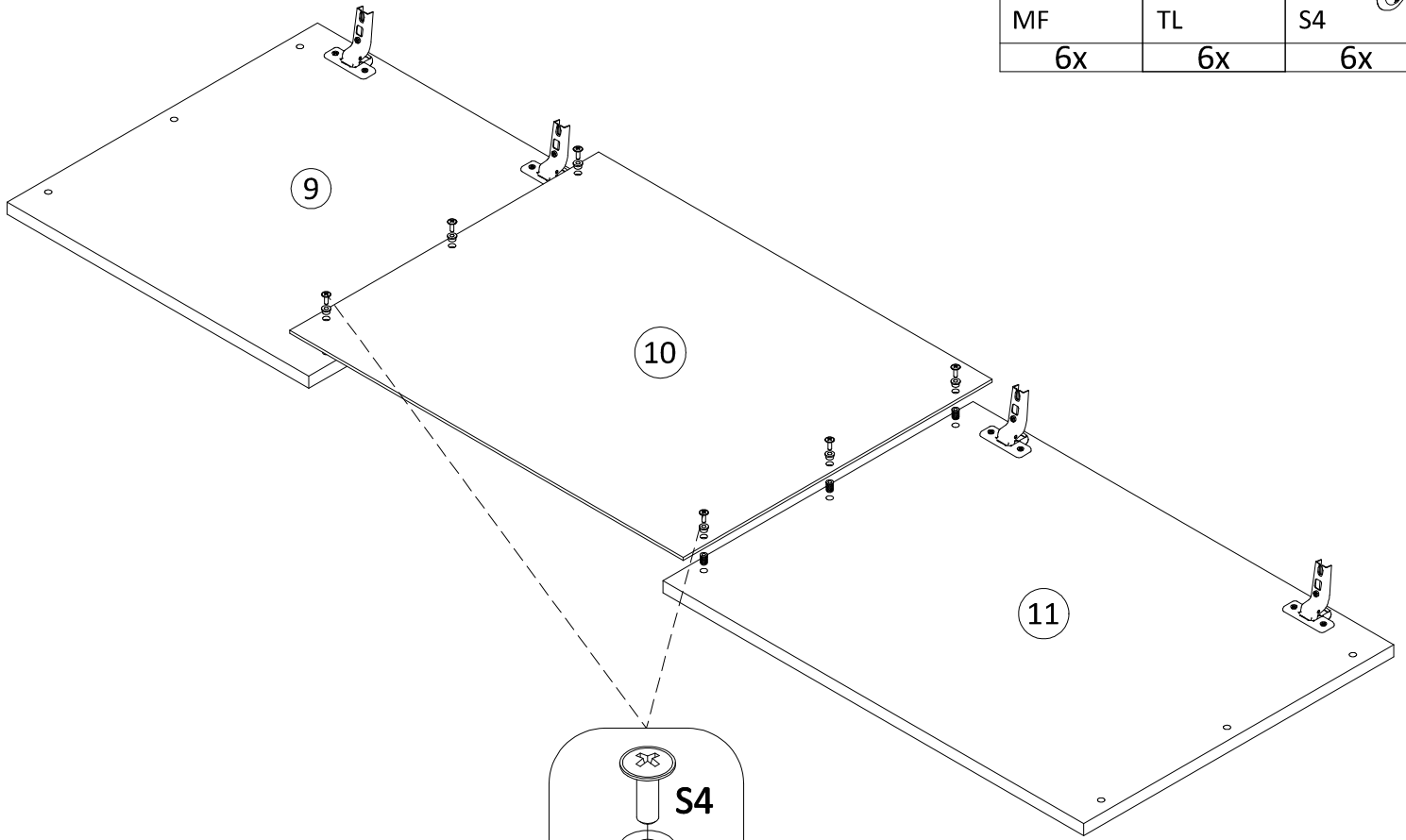



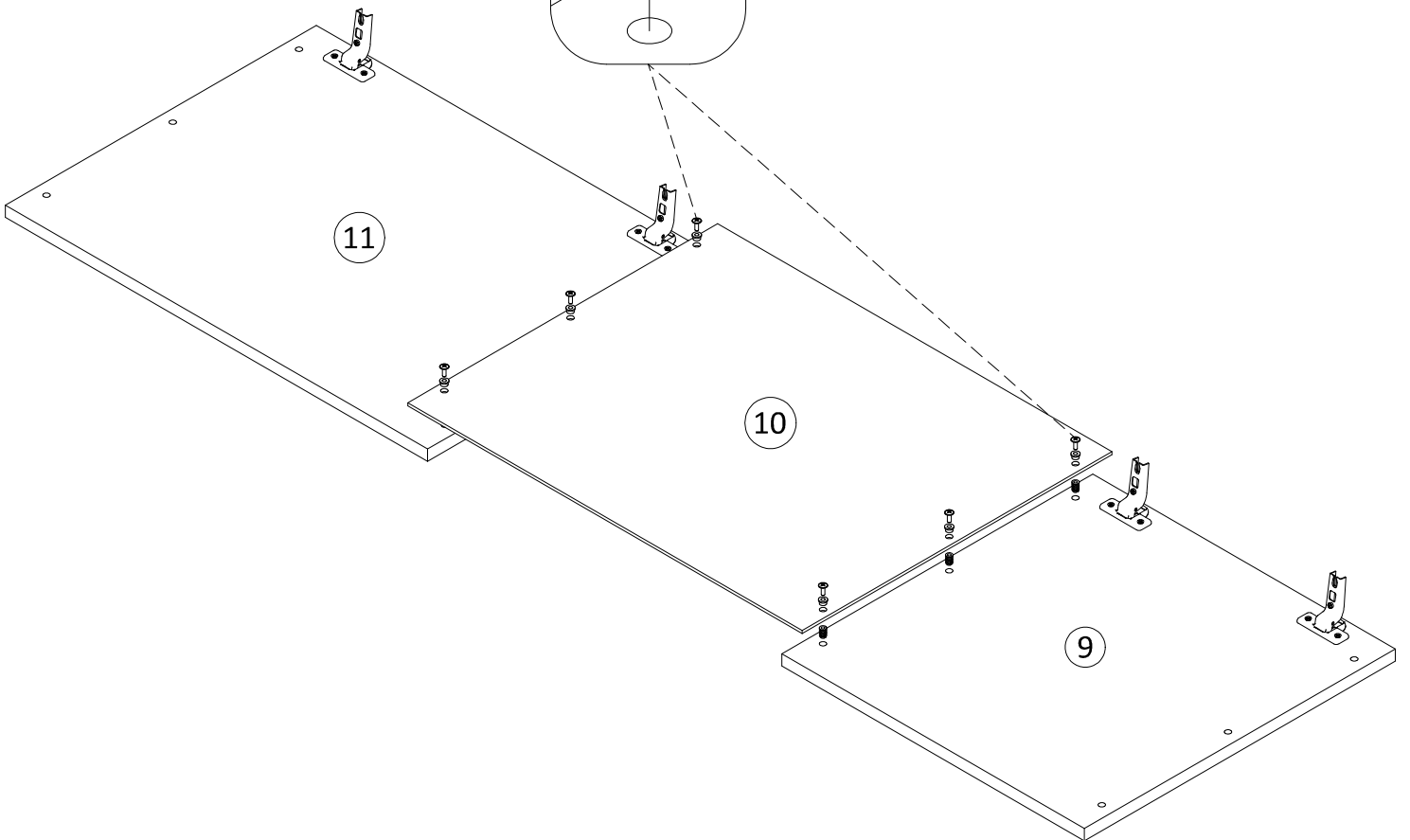



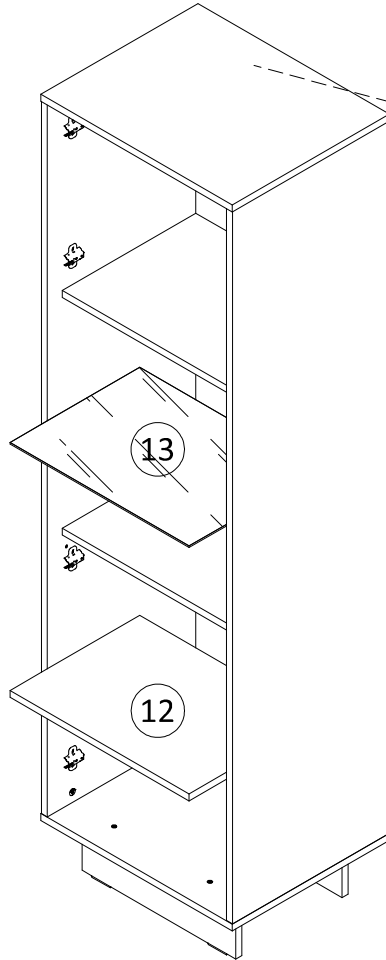
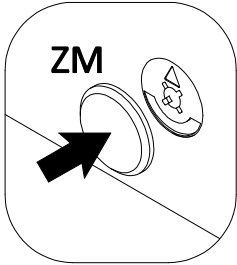
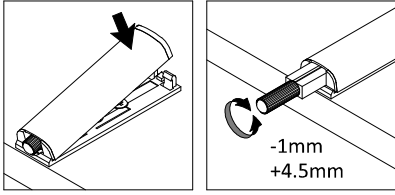

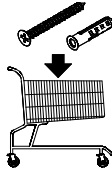
# Option R



# 14

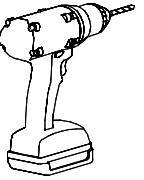

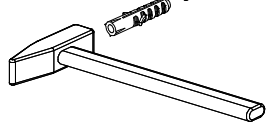
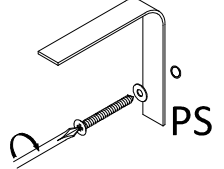
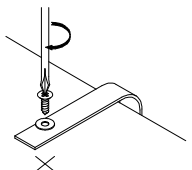
	 ZK 4x	 ZM 20x	 PS 1x
---	--	---	--

- 1  
- 2 
- 3  PS
- 4  

# 15

