

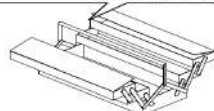

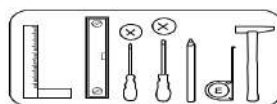

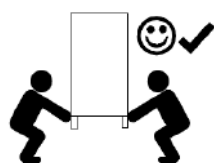

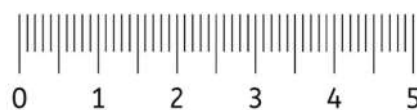

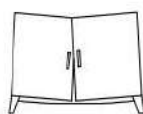
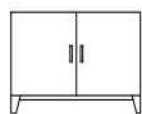
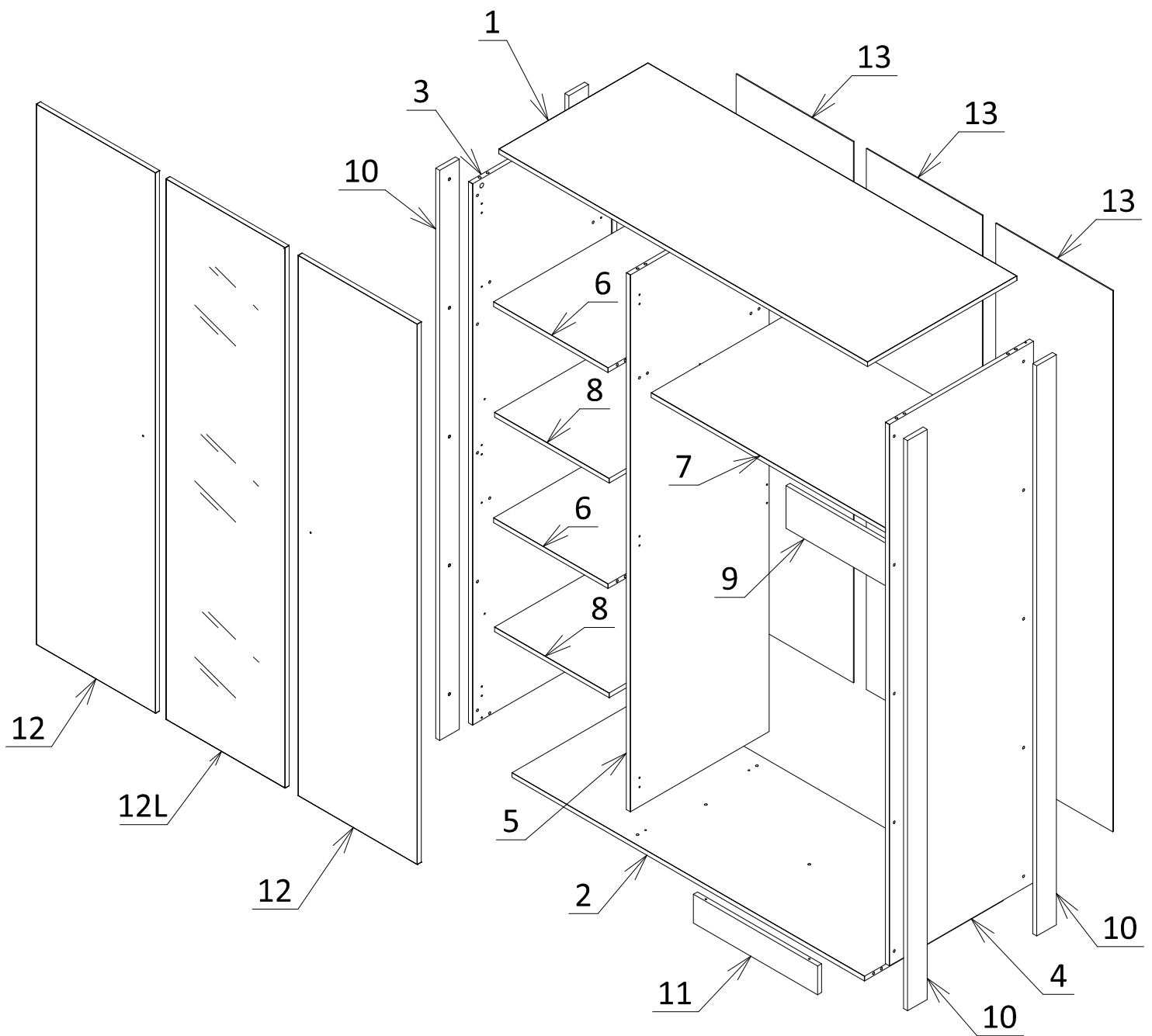
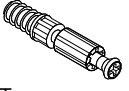

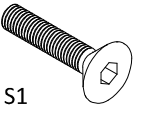



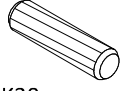
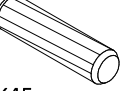
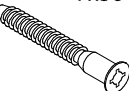
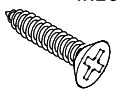
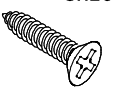
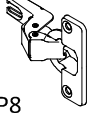
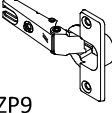
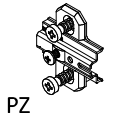
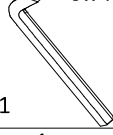
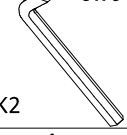

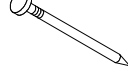
# ETHAN SZAFKA 3D

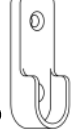

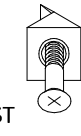
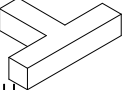



 L20,3 T	 M M	 M6x25 S1	 M6x12 MF	 L76 T2	 M4x22 WU	 K30	 K45		
24x	28x	20x	20x	2x	2x	20x	2x		
 7x50 XX	 4x16 W4	 3x16 W3	 ZP8	 ZP9	 PZ	 sw4 K1	 sw6 K2	 PP	 2x20 GW
x	22x	10x	3x	6x	9x	1x	1x	8x	30x
 LH	 DR	 UD	 SL	 P	 ST	 U	 PS	 ZM	 ZK
1x	1x	2x	6x	10x	13x	2x	1x	28x	22x

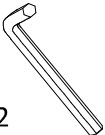

# 3

 SL	 MF	 K2
4x	20x	1x

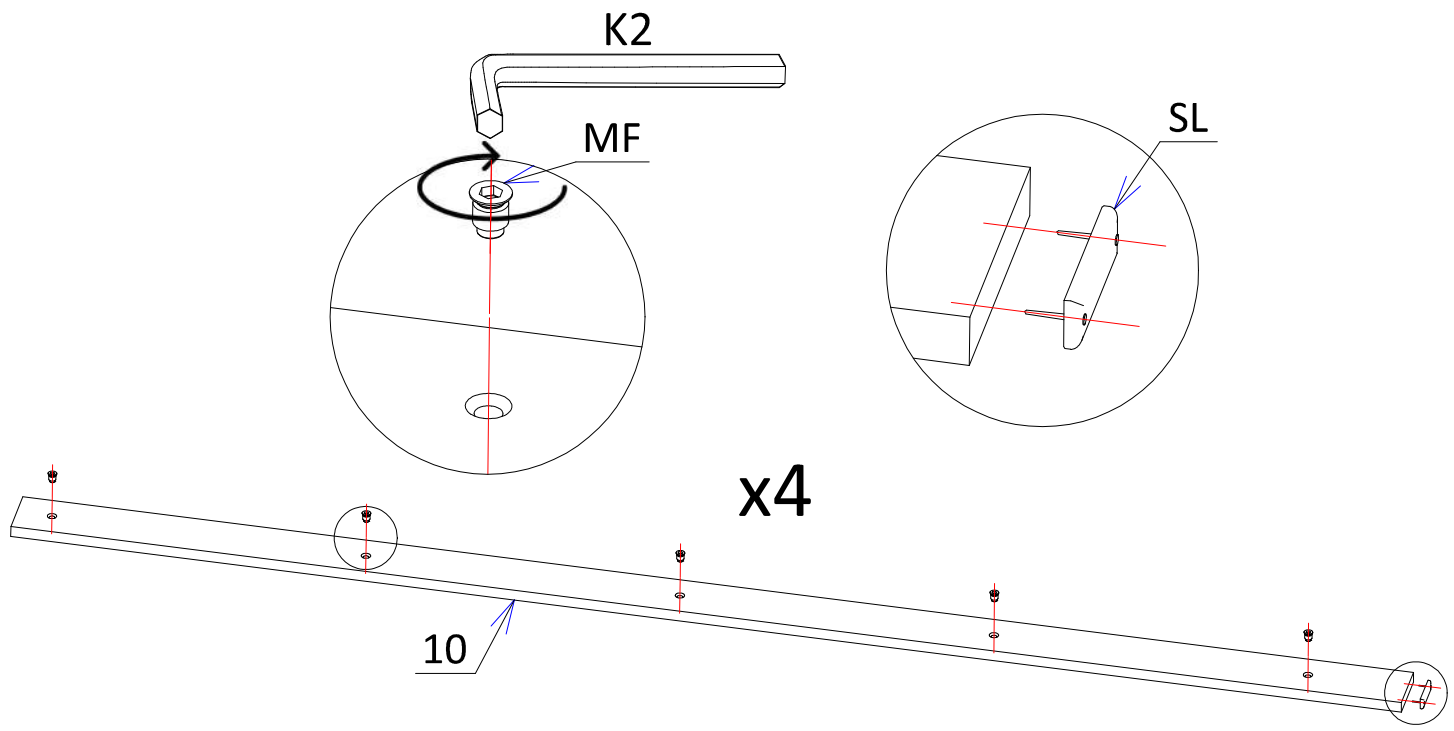

# 4

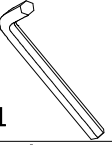
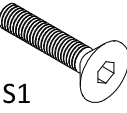
 K1	 S1
1x	10x

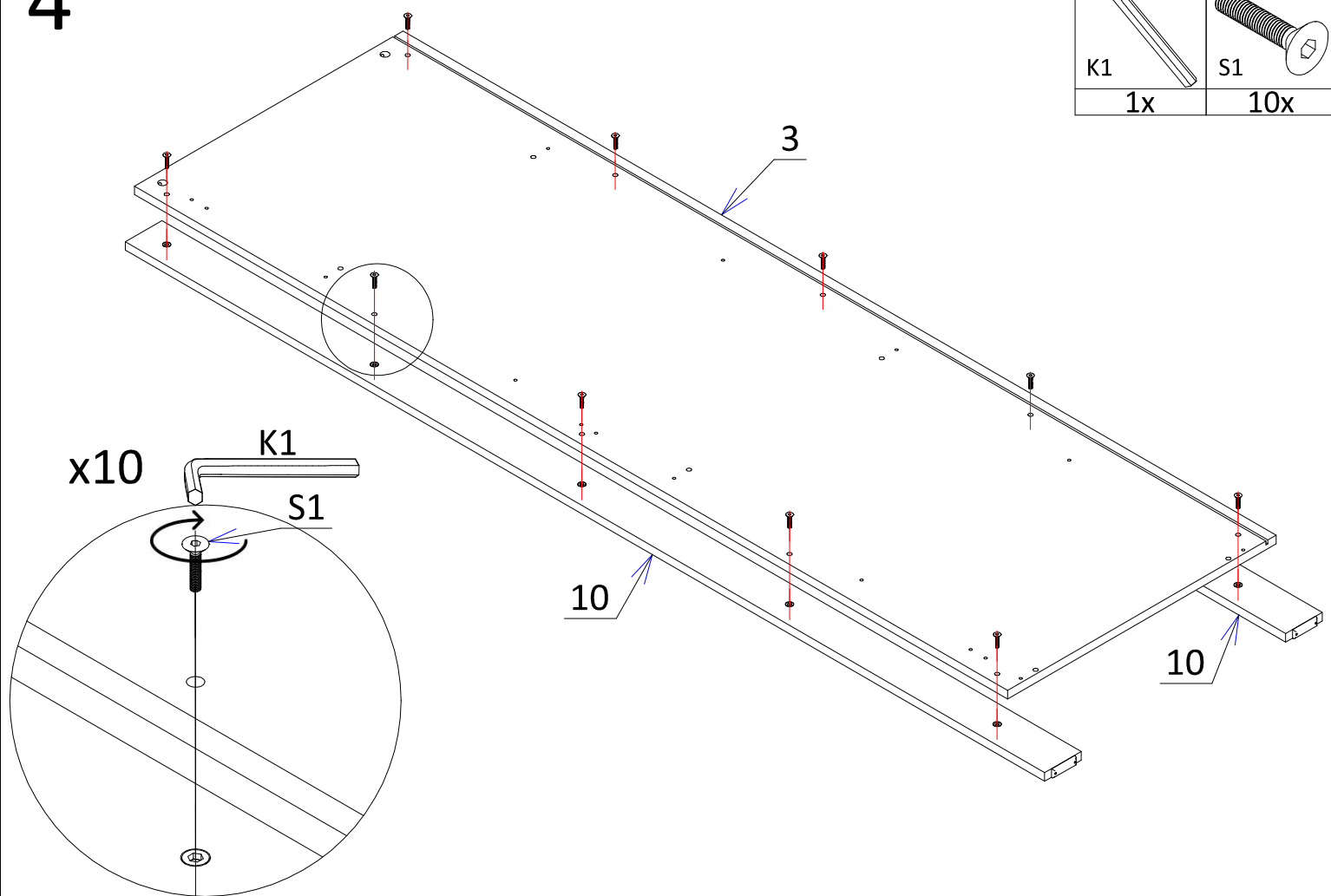

# 5

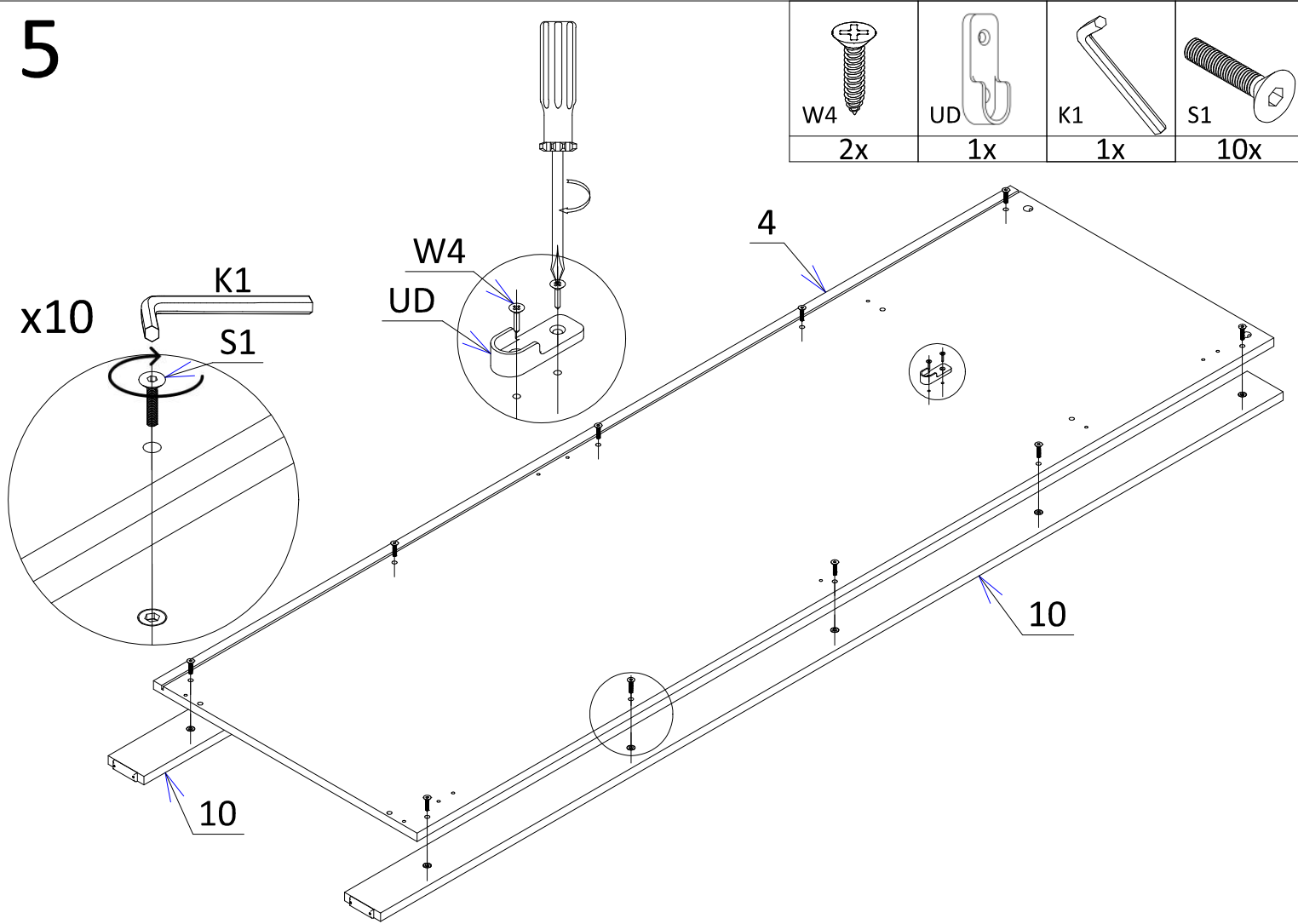

# 6

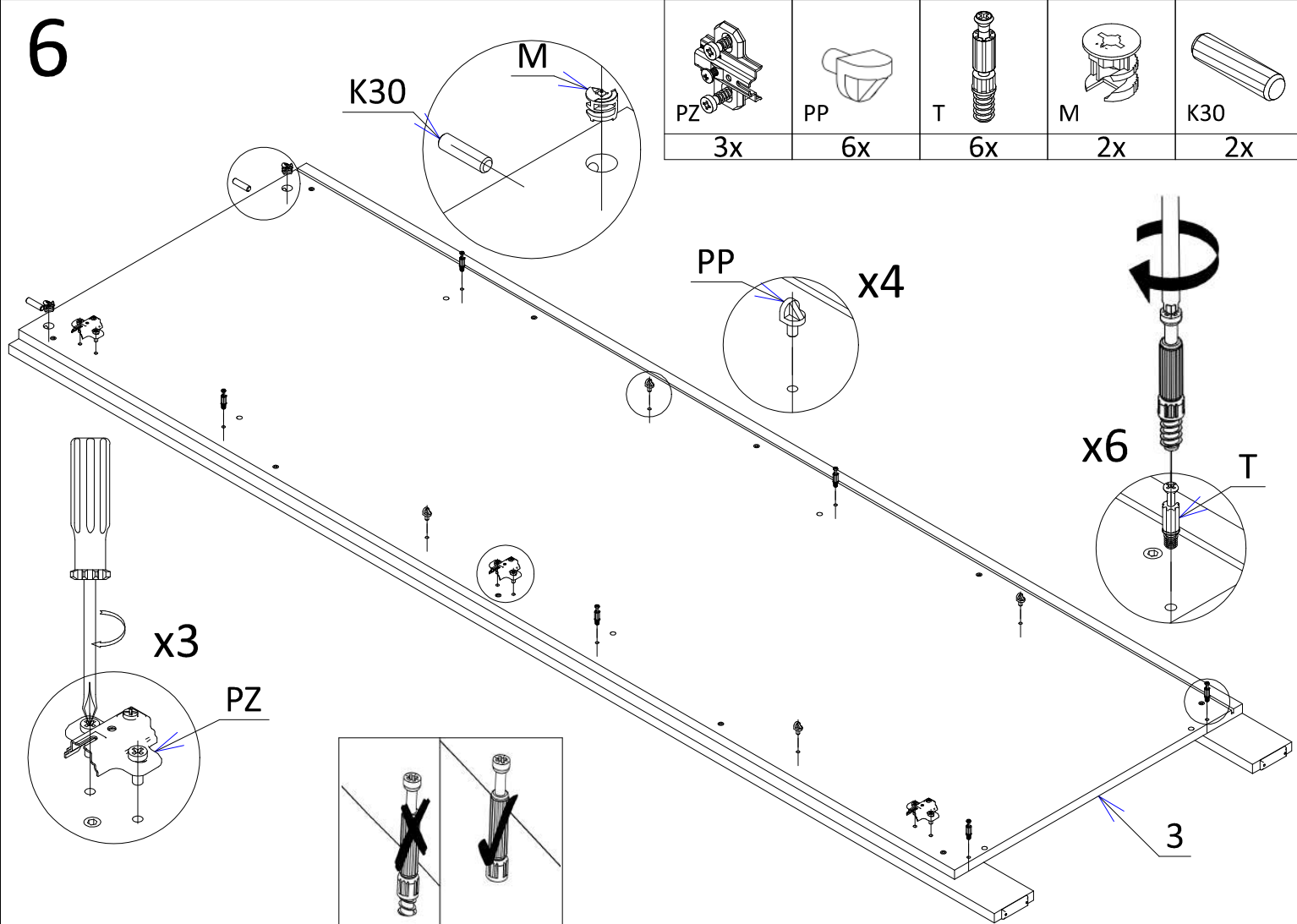

# 7

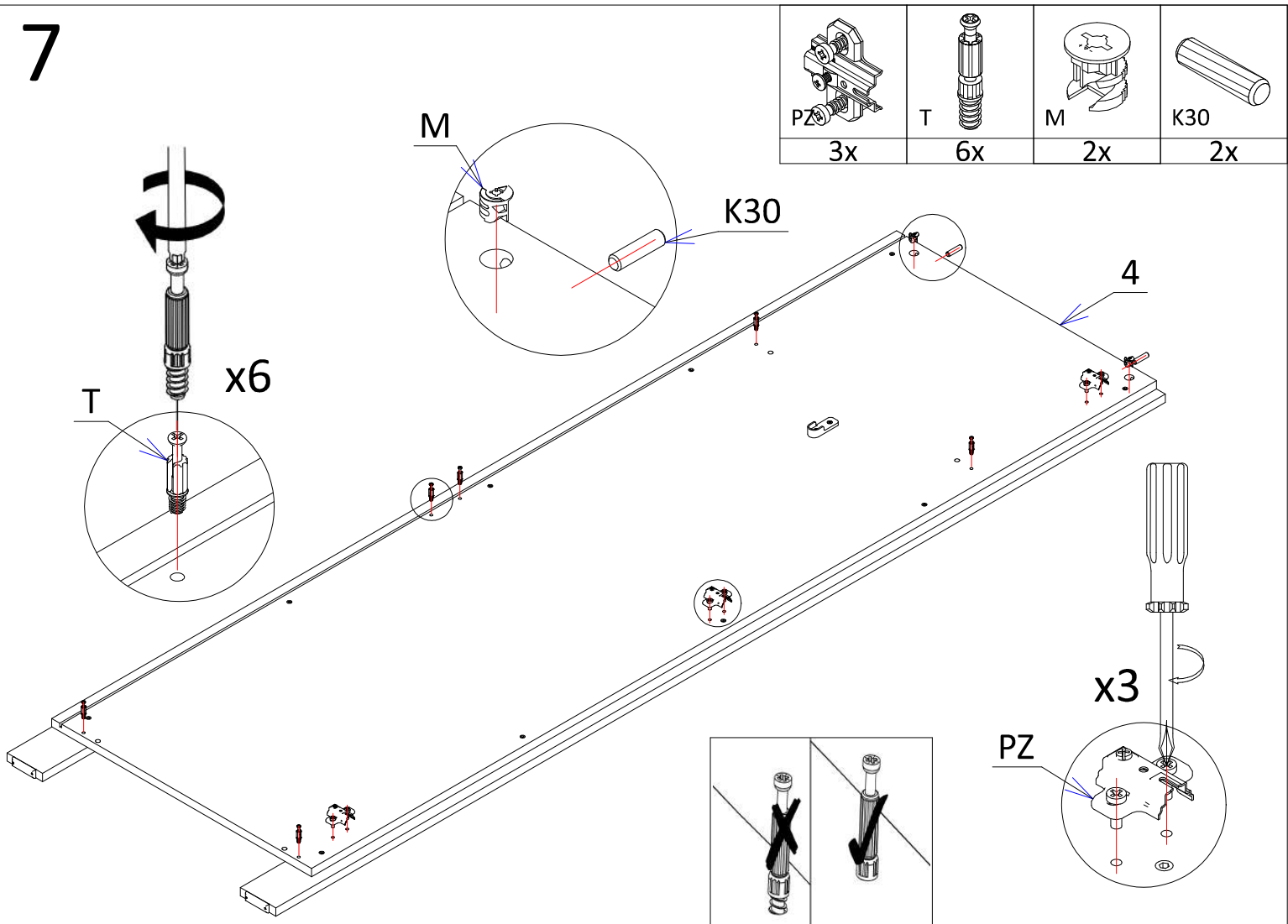

# 8

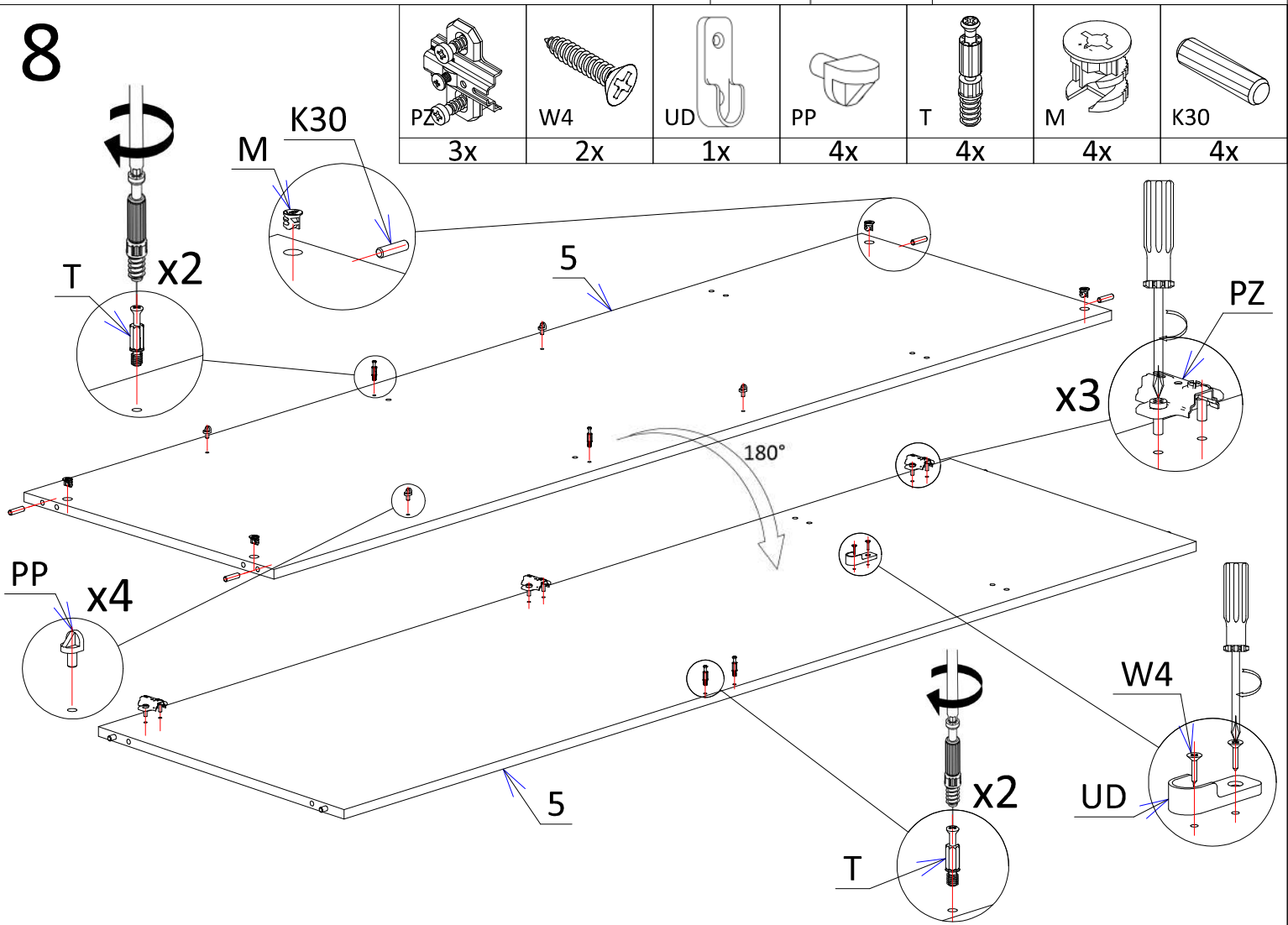

# 9

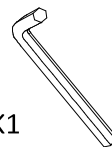
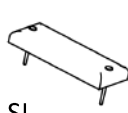
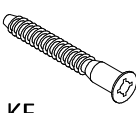
		
K1	SL	KF
1x	2x	2x

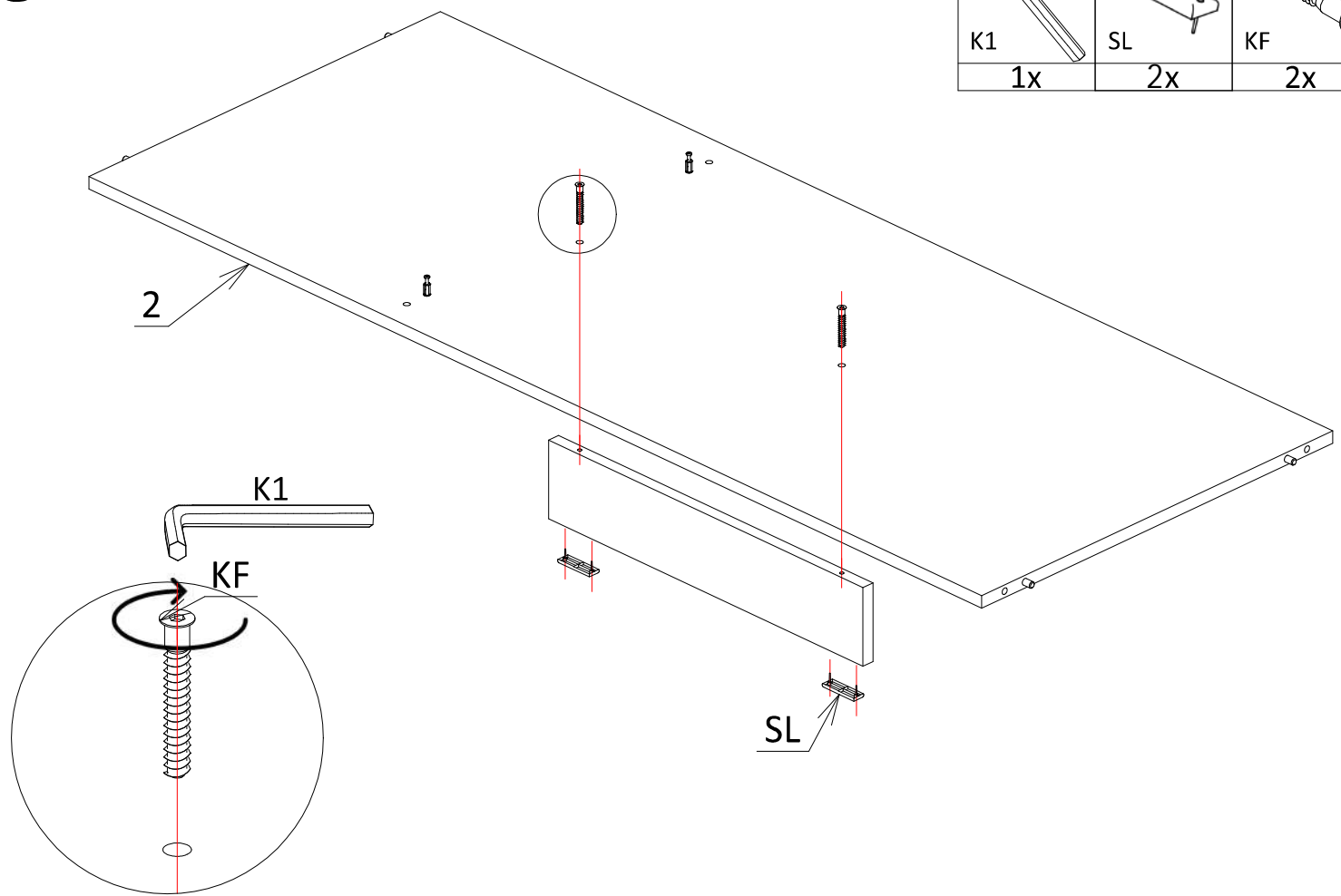

# 10

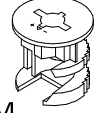

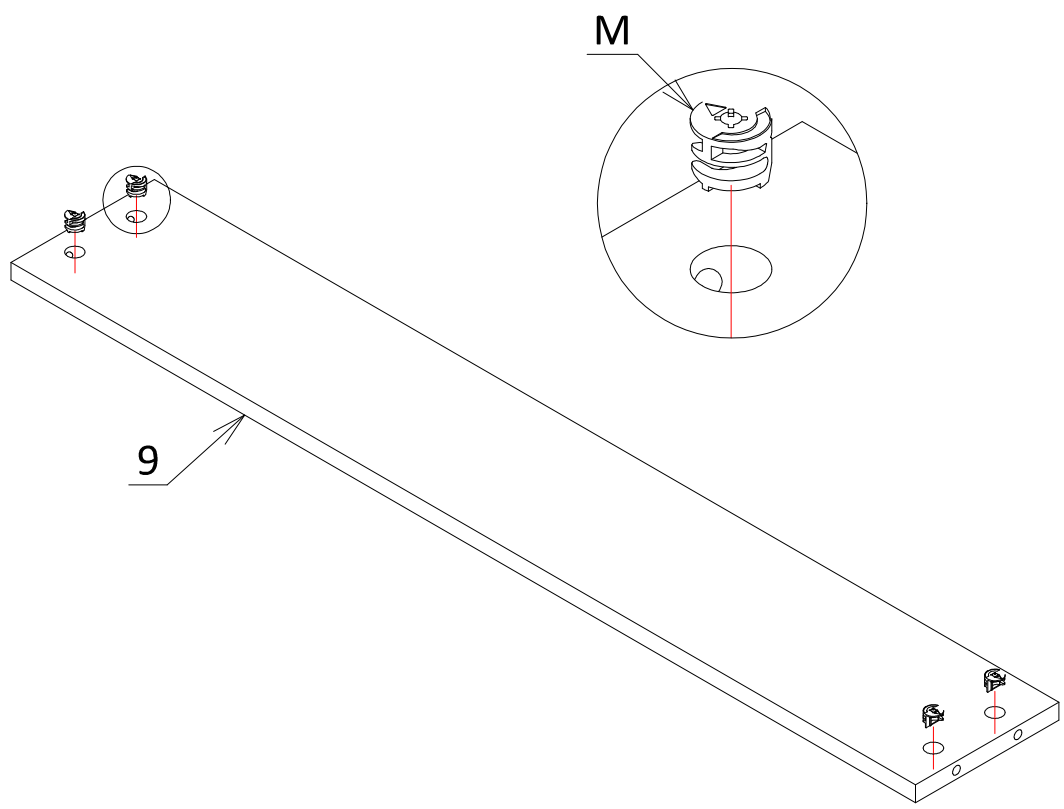
M
4x

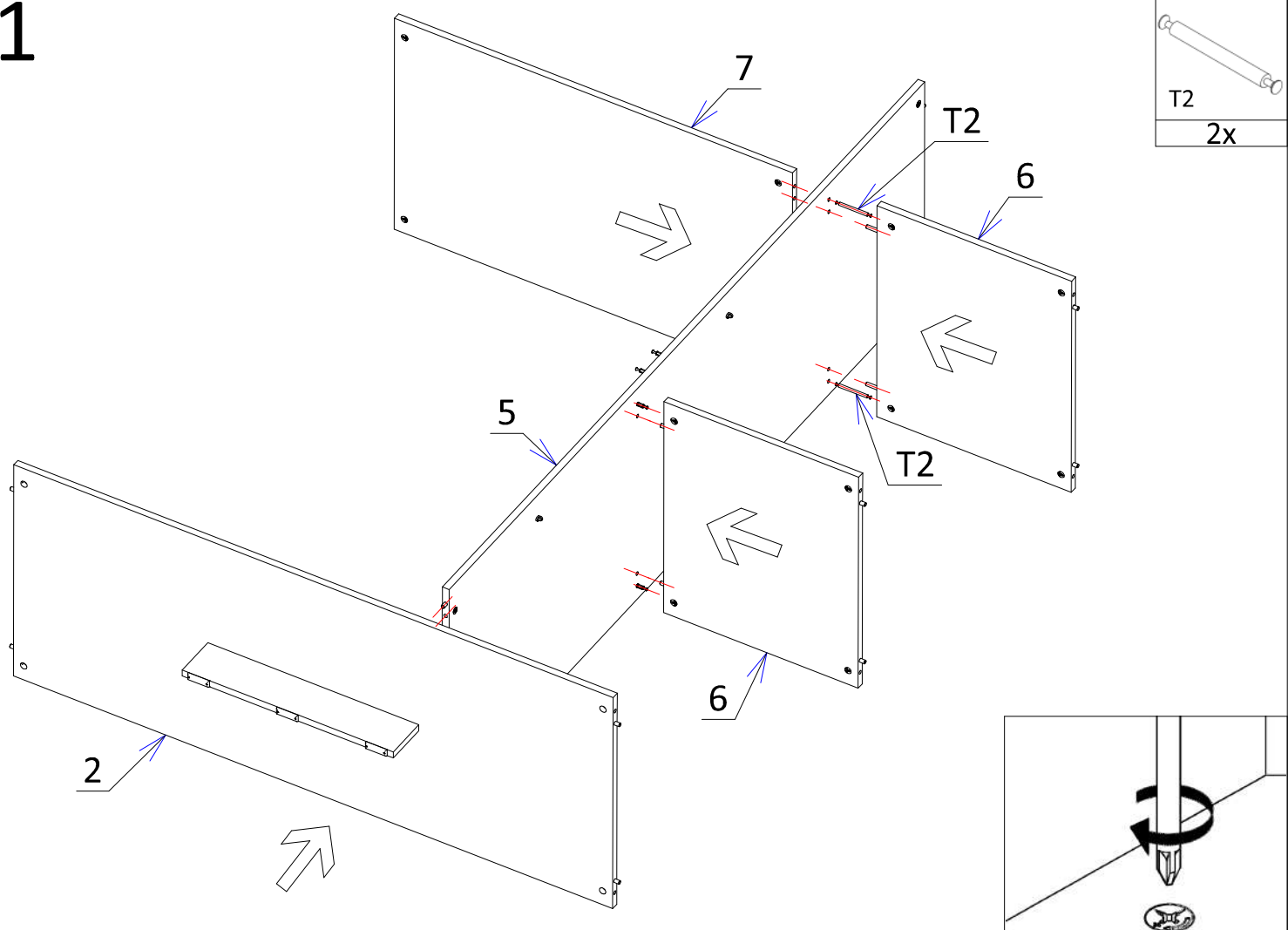

# 11

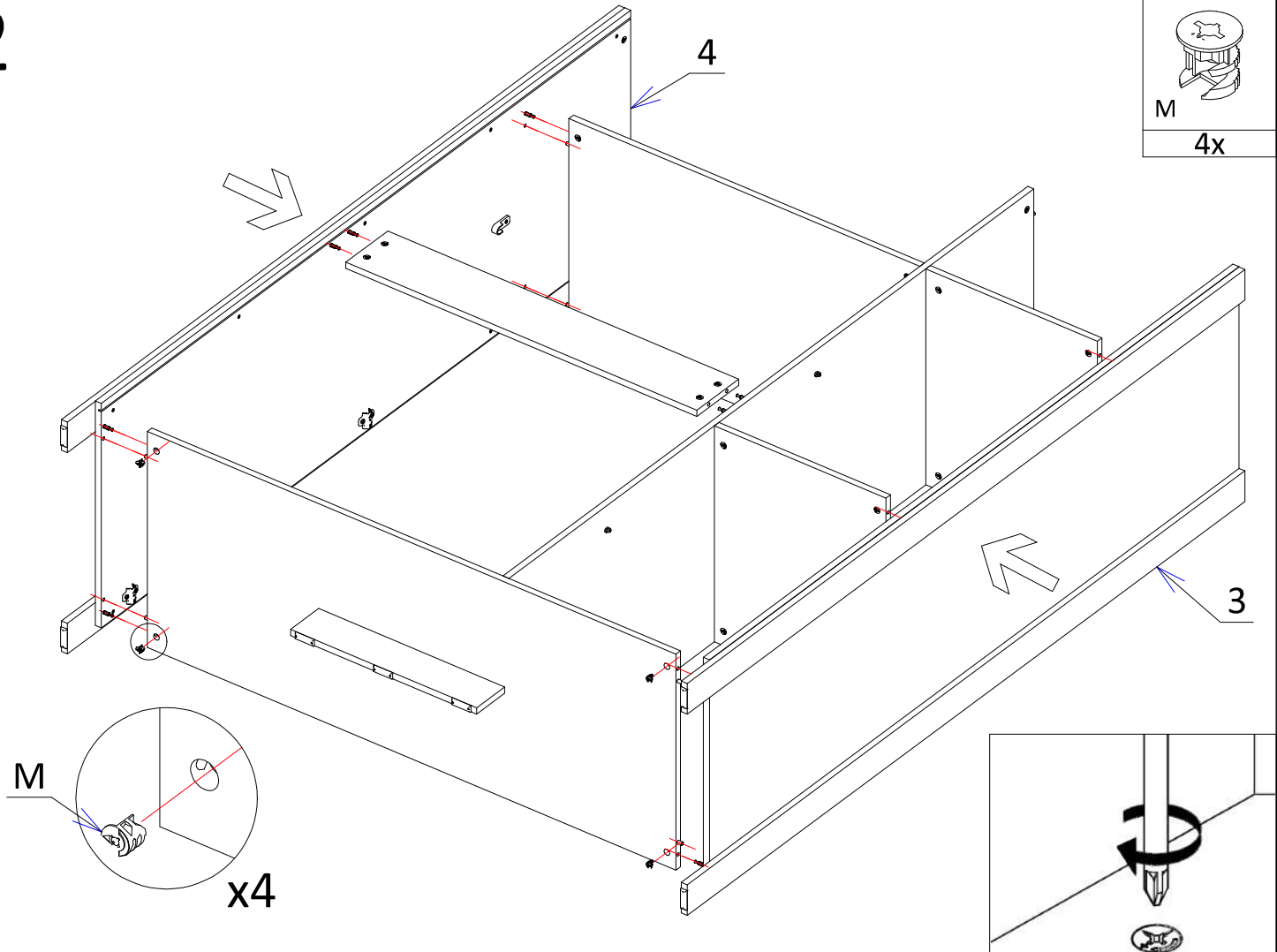

# 12



# 13

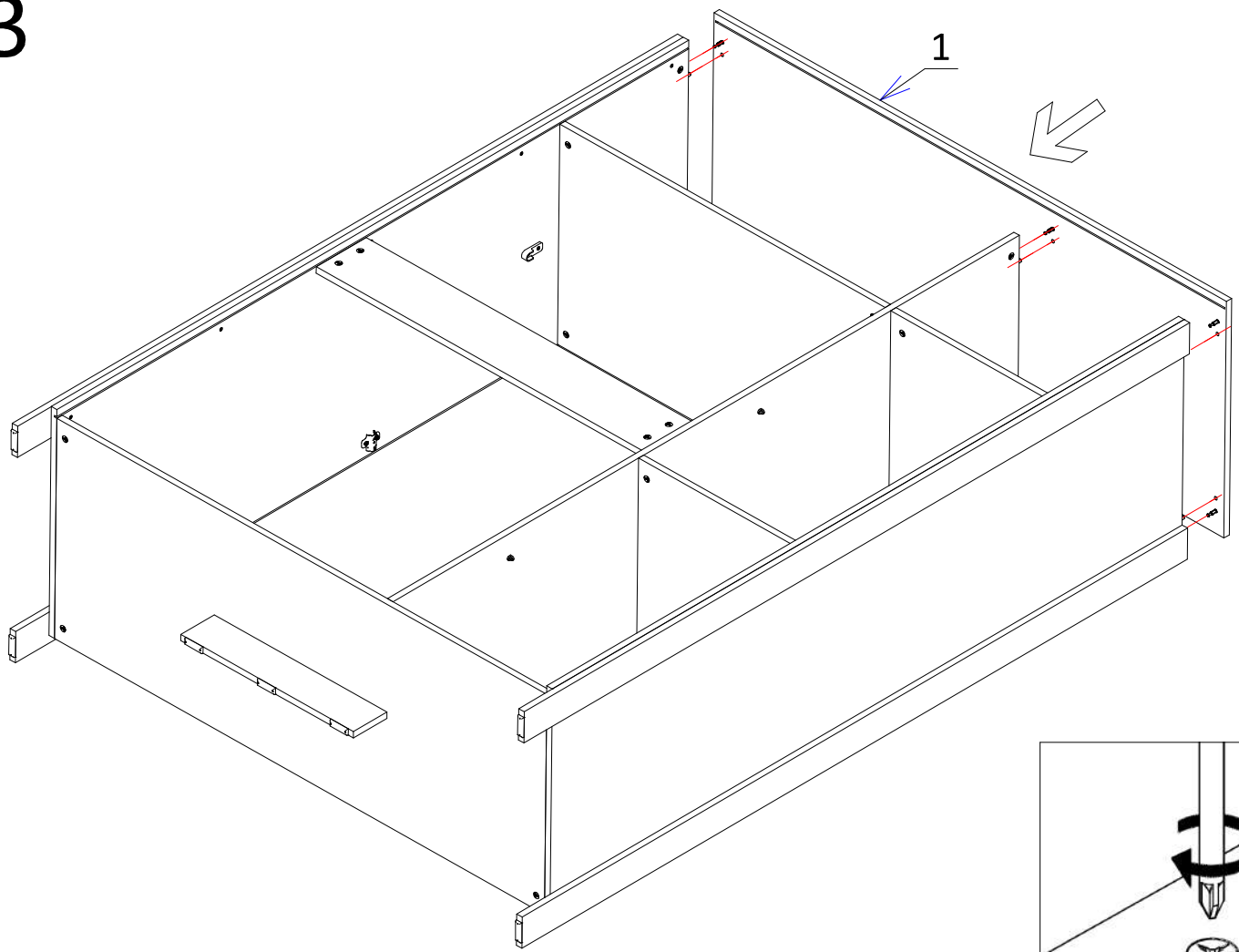

# 14

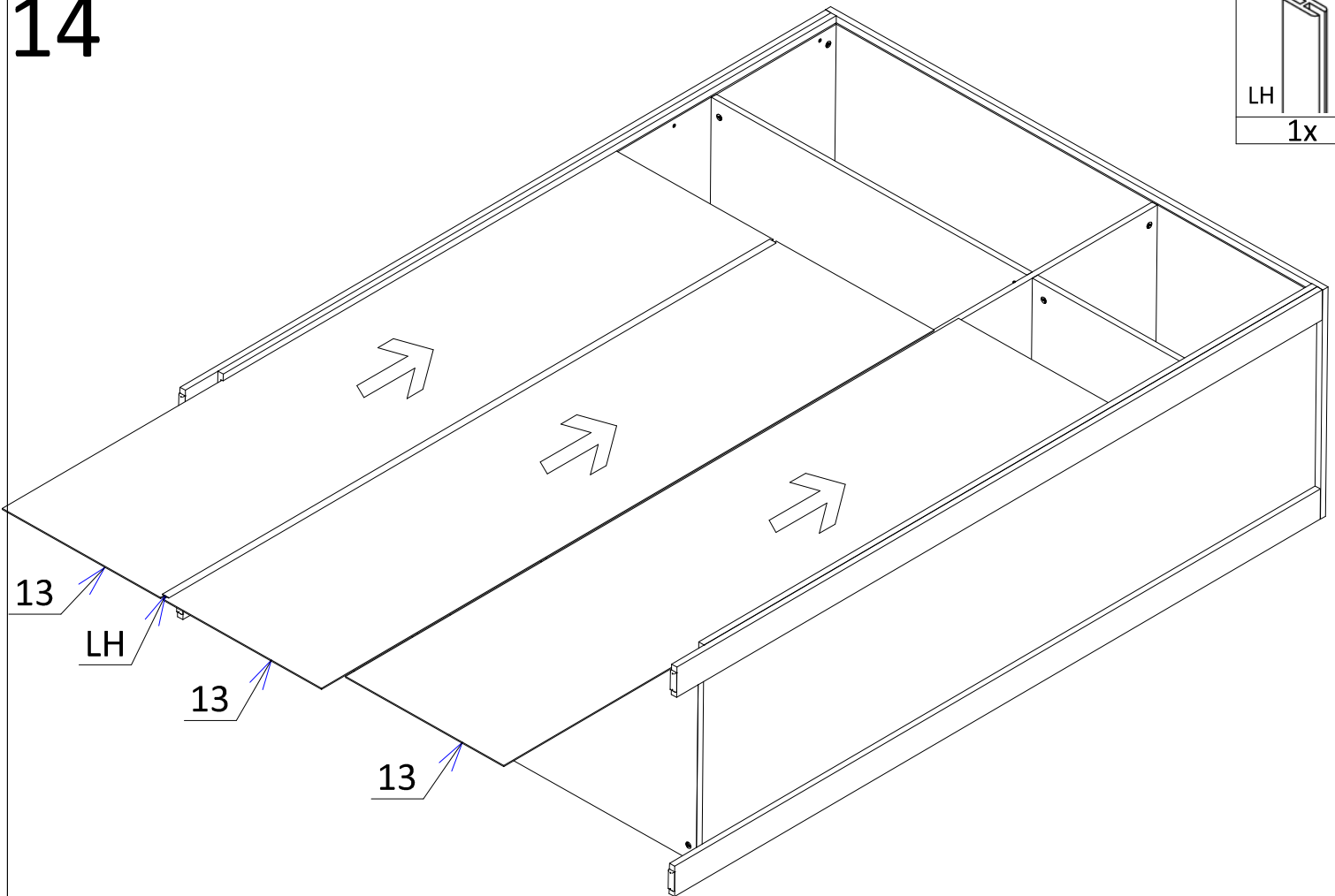

# 13

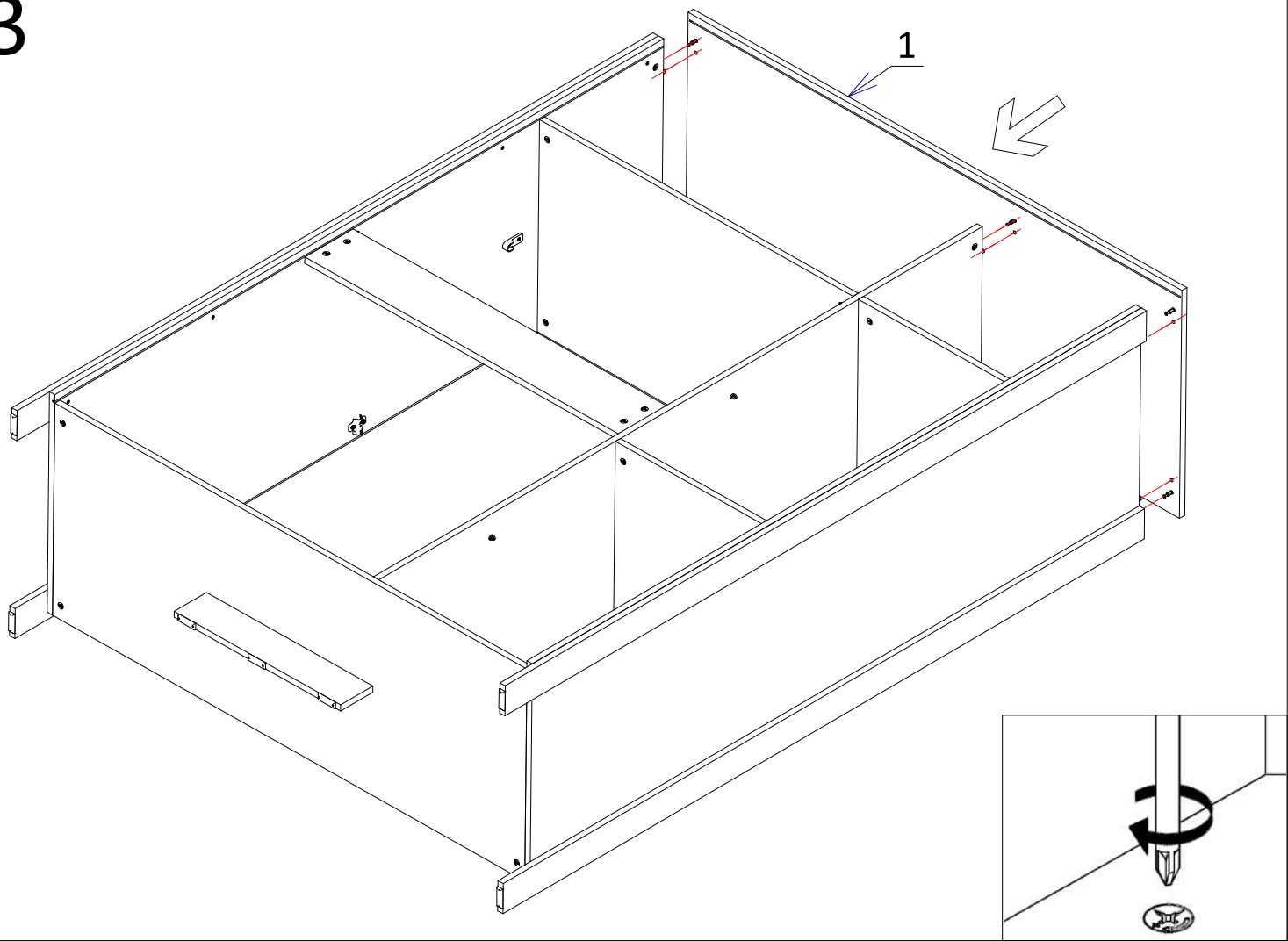

# 14

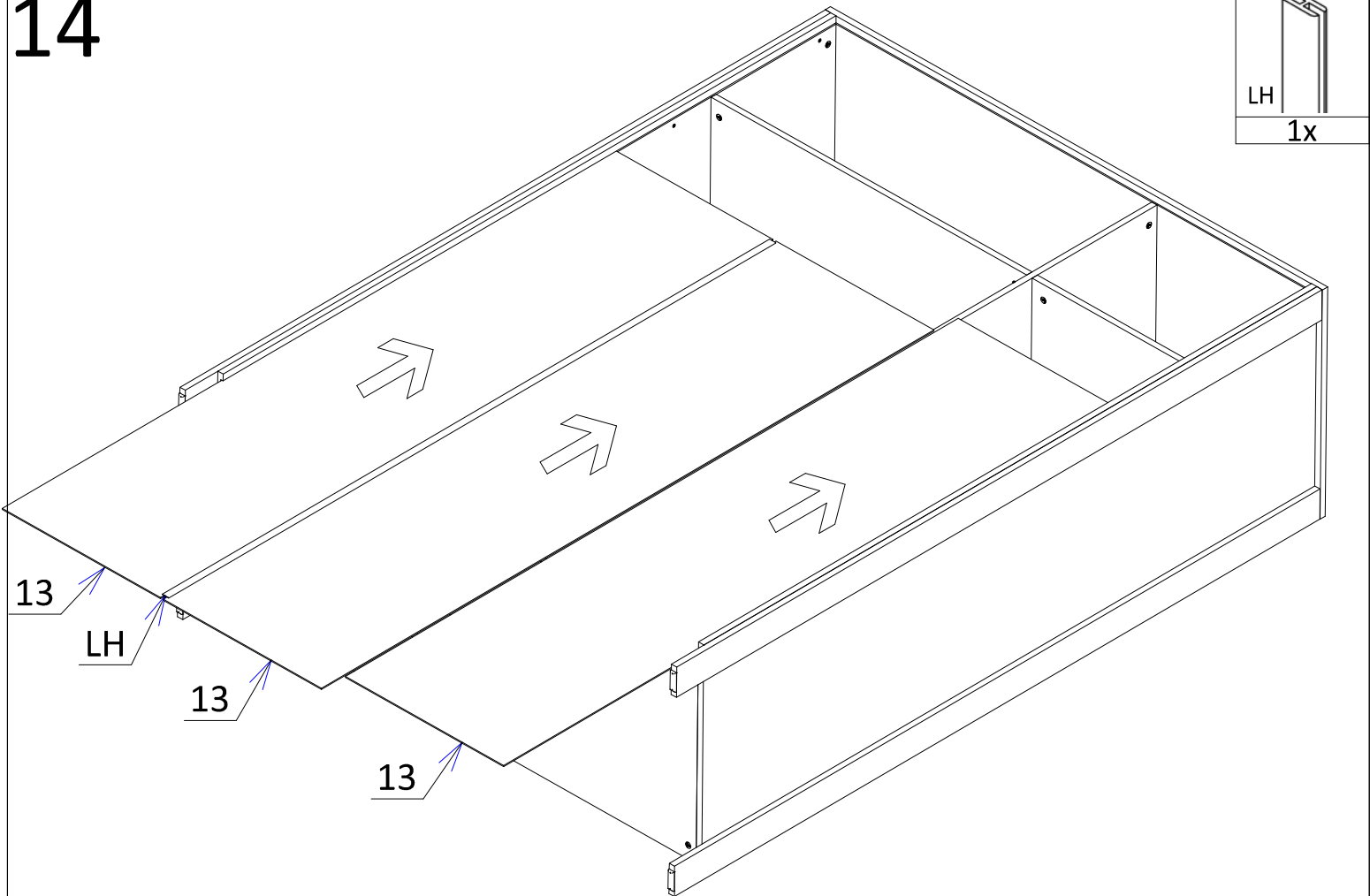

# 15

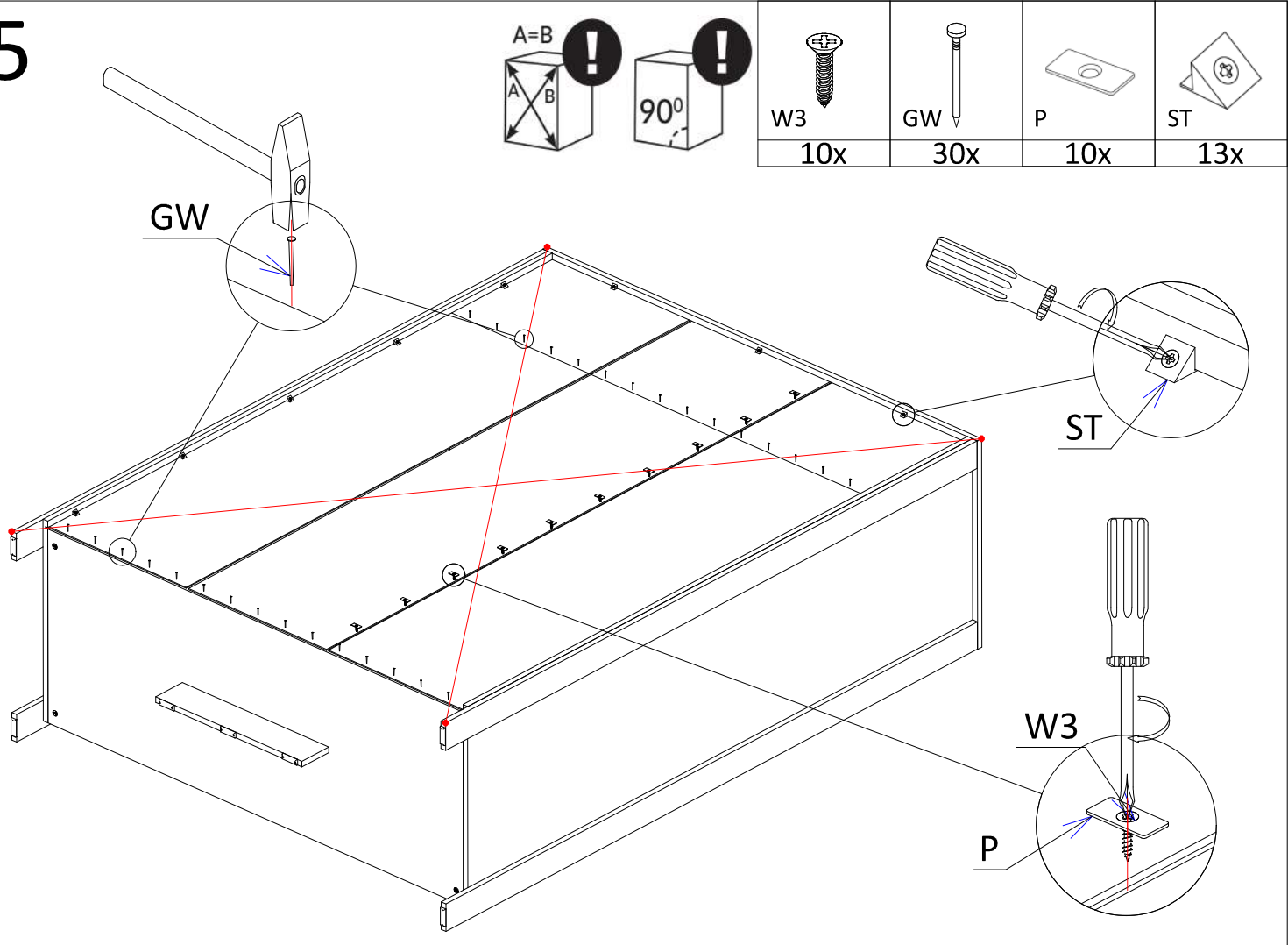

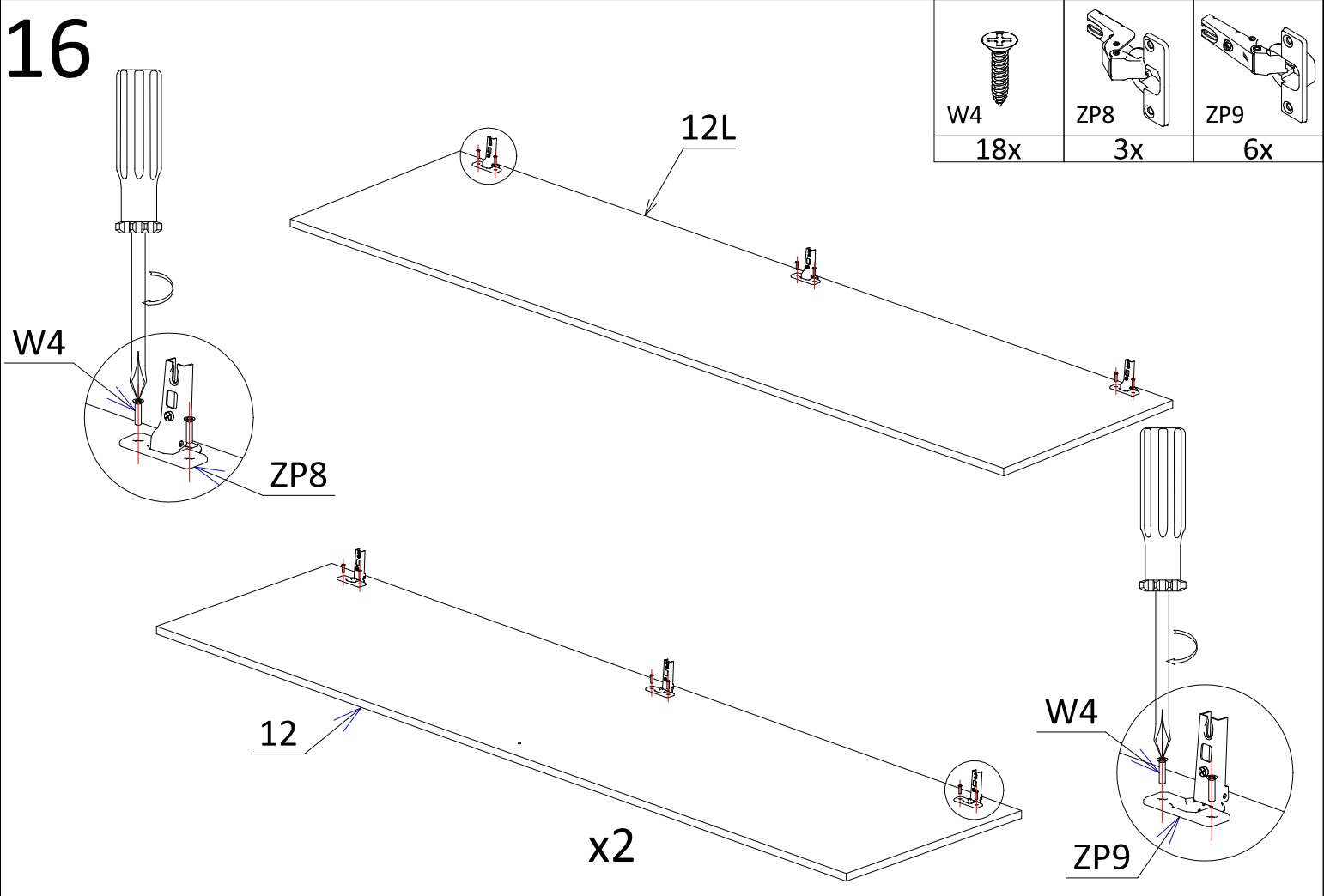

# 16

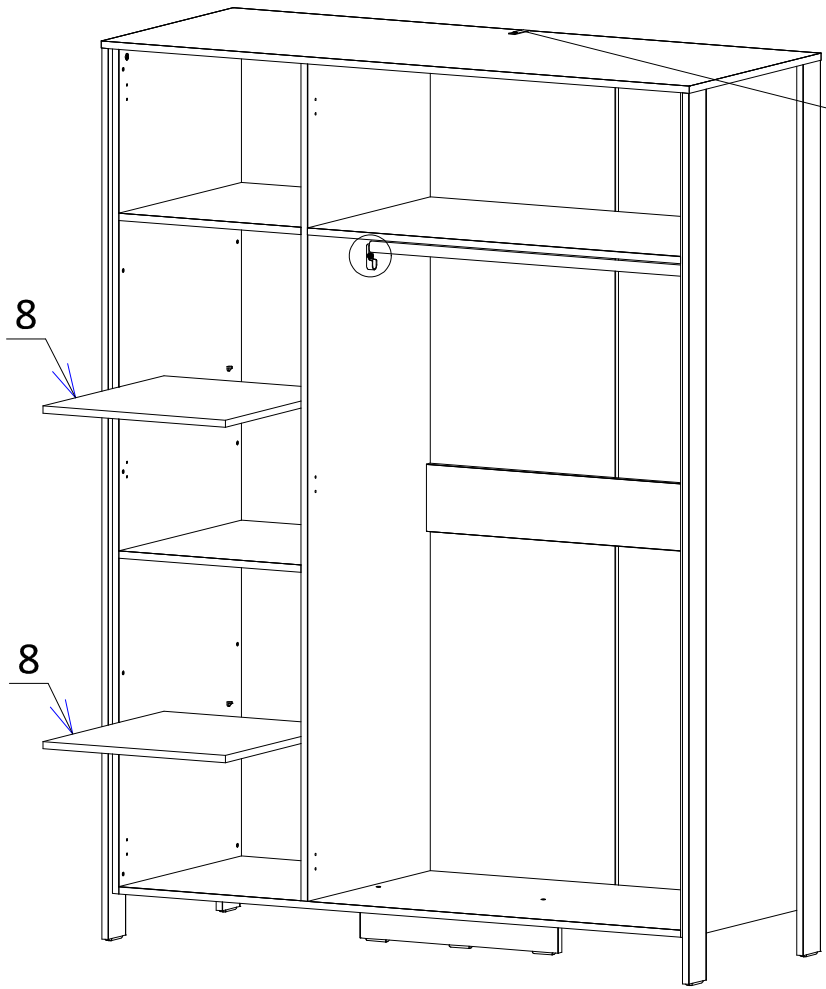

# 17



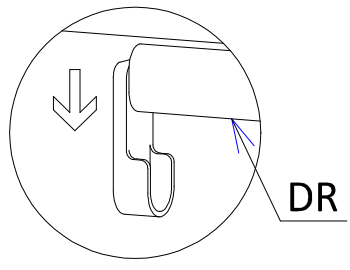
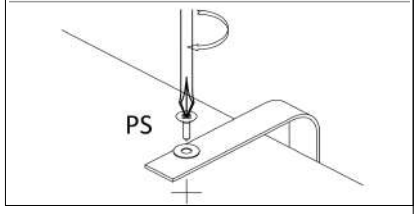
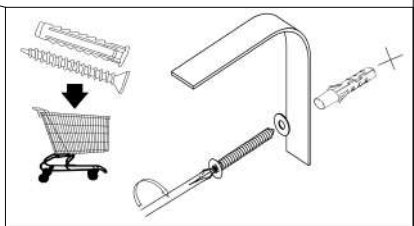

	
DR	PS
1x	1x

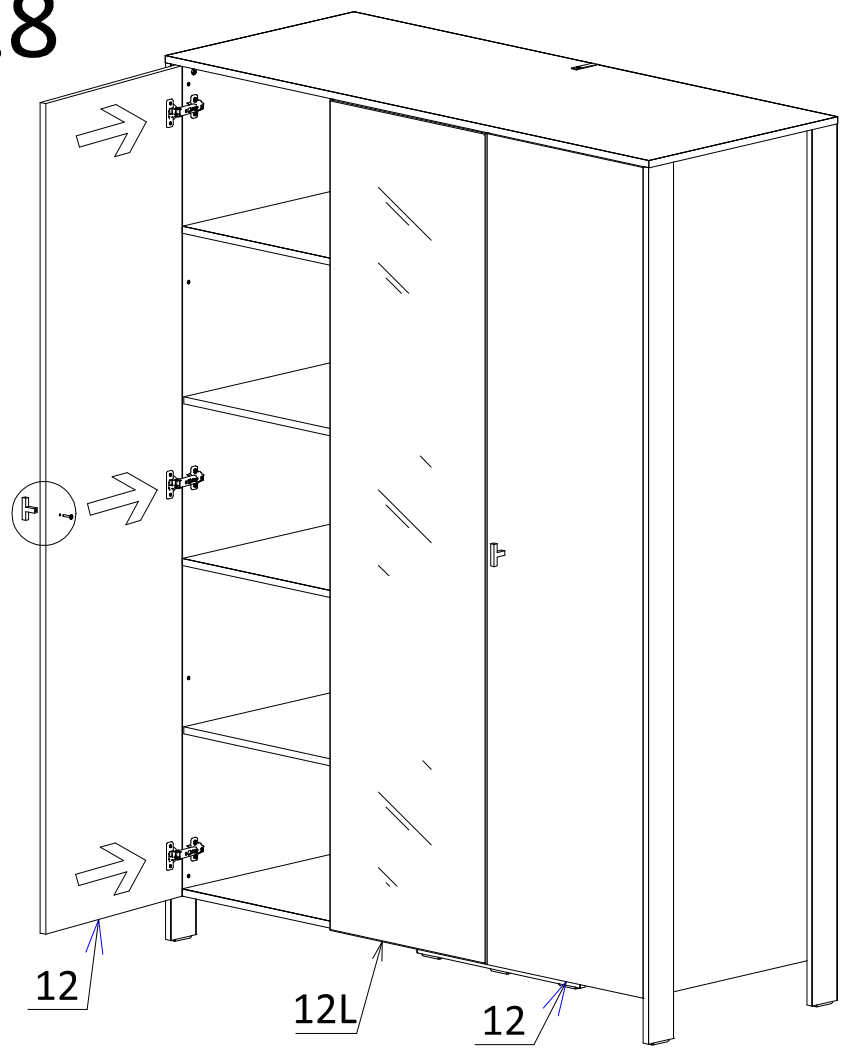

# 18



	
WU	U
2x	2x

