

WF306825AAW/WF306826AAW

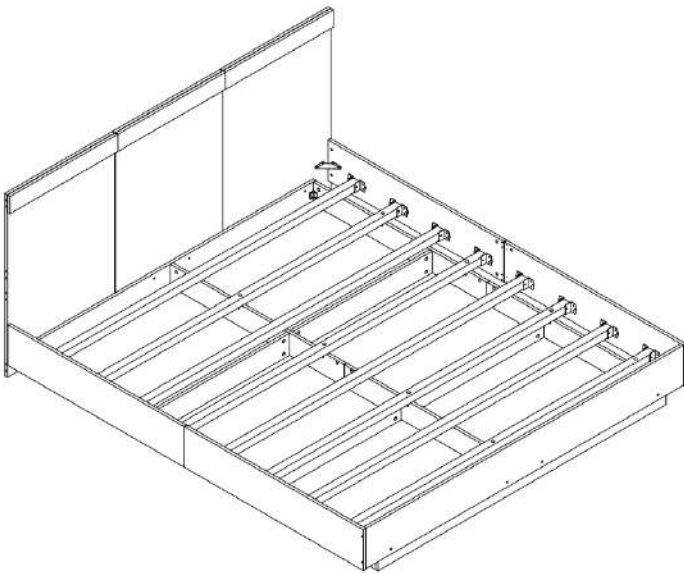

Please check that you have all the parts listed before you start assembling, if you do find that something is missing, do not continue assembly, please contact us immediately.

Note: Please do not fully tighten all the screws until the overall frame is built

Bitte überprüfen Sie, ob alle Teile mitgeliefert sind, bevor Sie mit der Montage beginnen. Wenn Sie festlegen, dass etwas fehlt, setzen Sie die Montage nicht fort. Bitte kontaktieren Sie uns sofort.

Achtung : Bitte ziehen Sie nicht alle Schrauben fest, bevor die Montage abgeschlossen ist !

D Gebrauchsanweisung

NL Gebruiksrichtlijnen

IT Istruzioni per l'uso

CZ Pokyny k použití

HU Használati útmutató

PT Instruções de utilização

SK Pokyny k použitiu

GB Instructions for use

FR Instructions d'utilisation

PL Instrukcja obsługi

ES Instrucciones de empleo

RO Instrucțiuni de folosire

RU Инструкция по монтажу

TR Kullanım talimatları

This set will be shipped by 2 boxes and they may arrive on different days. If both packages arrived but parts missing, please contact customer service.

Dieses Set ist in 2 Boxen enthalten. Wenn Sie keine vollen 2 Boxen erhalten, wenden Sie sich bitte an unseren Kundenservice

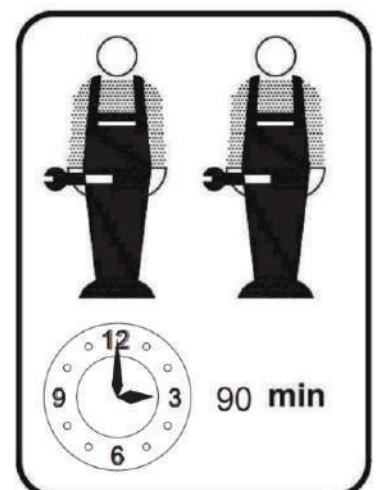

English

IMPORTANT ! KEEP FOR FUTURE REFERENCE : READ CAREFULLY

- To be assembled by an adult. Assembly must be checked by an adult before use
- WARNING ! Keep all screws, small parts and plastic bags out of the reach of children
- Properly identify all parts before assembling
- Never use your item if any of its parts are broken or missing
- Should any problems arise, please contact our After Sales Service
- Manufacturer's instructions shall be followed at all times
- Care: Clean with a soft, dry cloth. In case of larger stains, carefully rub with a slightly damp, non-abrasive sponge
- Avoid the risk of fire by not placing furniture near sources of ignition or hot items
- Do not jump on the bed

Deutsch

WICHTIG ! ZUM SPÄTEREN NACHSCHLAGEN AUFBEWAHREN: SORGFÄLTIG LESEN

- Muss von einem Erwachsenen zusammengebaut werden. Der Zusammenbau muss vor dem Gebrauch von einem Erwachsenen überprüft werden
- WARNUNG! Bewahren Sie alle Schrauben, Kleinteile und Plastikbeutel außerhalb der Reichweite von Kindern auf
- Kennzeichnen Sie vor dem Zusammenbau alle Teile richtig
- Benutzen Sie Ihren Artikel niemals, wenn Teile gebrochen sind oder fehlen
- Sollten Probleme auftreten, wenden Sie sich bitte an unseren Kundendienst
- Die Anweisungen des Herstellers sind stets zu befolgen
- Pflege: Mit einem weichen, trockenen Tuch reinigen. Bei größeren Flecken vorsichtig mit einem leicht feuchten, nicht scheuernden Schwamm abreiben. nicht scheuernden Schwamm
- Vermeiden Sie die Gefahr eines Brandes, indem Sie die Möbel nicht in der Nähe von Zündquellen oder heißen Gegenständen aufstellen
- Nicht auf das Bett springen

Français

IMPORTANT ! CONSERVER POUR RÉFÉRENCE ULTÉRIEURE : LIRE ATTENTIVEMENT

- Le montage doit être effectué par un adulte. Le montage doit être vérifié par un adulte avant Utilisation
- ATTENTION ! Tenir les vis, les petites pièces et les sachets en plastique hors de portée des enfants
- Identifiez correctement toutes les pièces avant de les assembler
- N'utilisez jamais votre article si l'une de ses pièces est cassée ou manquante
- En cas de problème, veuillez contacter notre service après-vente
- Les instructions du fabricant doivent être respectées à tout moment
- Entretien : nettoyer avec un chiffon doux et sec. En cas de taches plus importantes, frotter soigneusement avec une éponge non abrasive légèrement humide. légèrement humide et non Abrasive
- Évitez les risques d'incendie en ne plaçant pas les meubles à proximité de sources d'inflammation ou d'objets chauds
- Ne pas sauter sur le lit

Italiano

IMPORTANTE! CONSERVARE PER RIFERIMENTO FUTURO: LEGGERE ATTENTAMENTE

- Deve essere assemblato da un adulto. L'assemblaggio deve essere controllato da un adulto prima dell'uso
- **ATTENZIONE!** Tenere tutte le viti, le piccole parti e i sacchetti di plastica fuori dalla portata dei bambini
- Identificare correttamente tutte le parti prima dell'assemblaggio
- Non utilizzare mai l'articolo se alcune parti sono rotte o mancanti
- In caso di problemi, si prega di contattare il nostro Servizio Post Vendita
- Le istruzioni del produttore devono essere sempre seguite
- Cura: Pulire con un panno morbido e asciutto. In caso di macchie più estese, strofinare accuratamente con una spugna leggermente umida e nonspugna leggermente umida e non abrasiva
- Evitare il rischio di incendio, non collocando i mobili vicino a fonti di accensione o a oggetti caldi
- Non saltare sul letto

Español

¡ IMPORTANTE ! CONSERVELO PARA FUTURAS CONSULTAS: LEA ATENTAMENTE

- Debe ser montado por un adulto. El montaje debe ser comprobado por un adulto antes del uso
- ADVERTENCIA Mantenga todos los tornillos, piezas pequeñas y bolsas de plástico fuera del alcance de los niños.
- Identifique correctamente todas las piezas antes de montarlas
 - Nunca utilice su artículo si alguna de sus piezas está rota o falta
 - Si surge algún problema, póngase en contacto con nuestro Servicio Postventa
 - Las instrucciones del fabricante deben seguirse en todo momento
 - Cuidado: Limpiar con un paño suave y seco. En caso de manchas más grandes, frote cuidadosamente con una esponja no abrasiva ligeramente humedecida.
 - Evite el riesgo de incendio no colocando los muebles cerca de fuentes de ignición u objetos calientes.
 - No saltar sobre la cama.

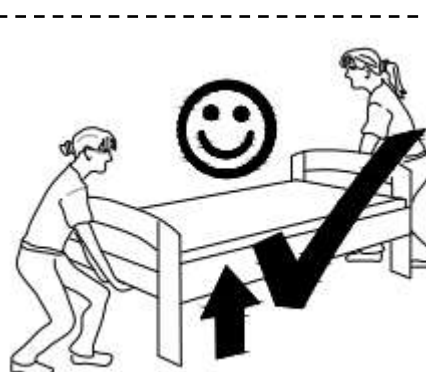
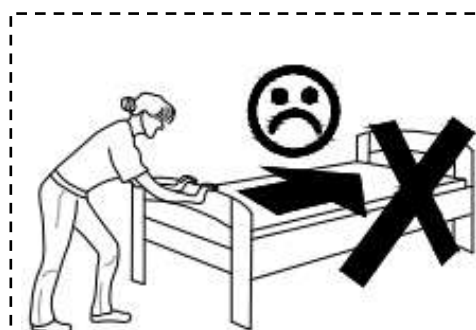

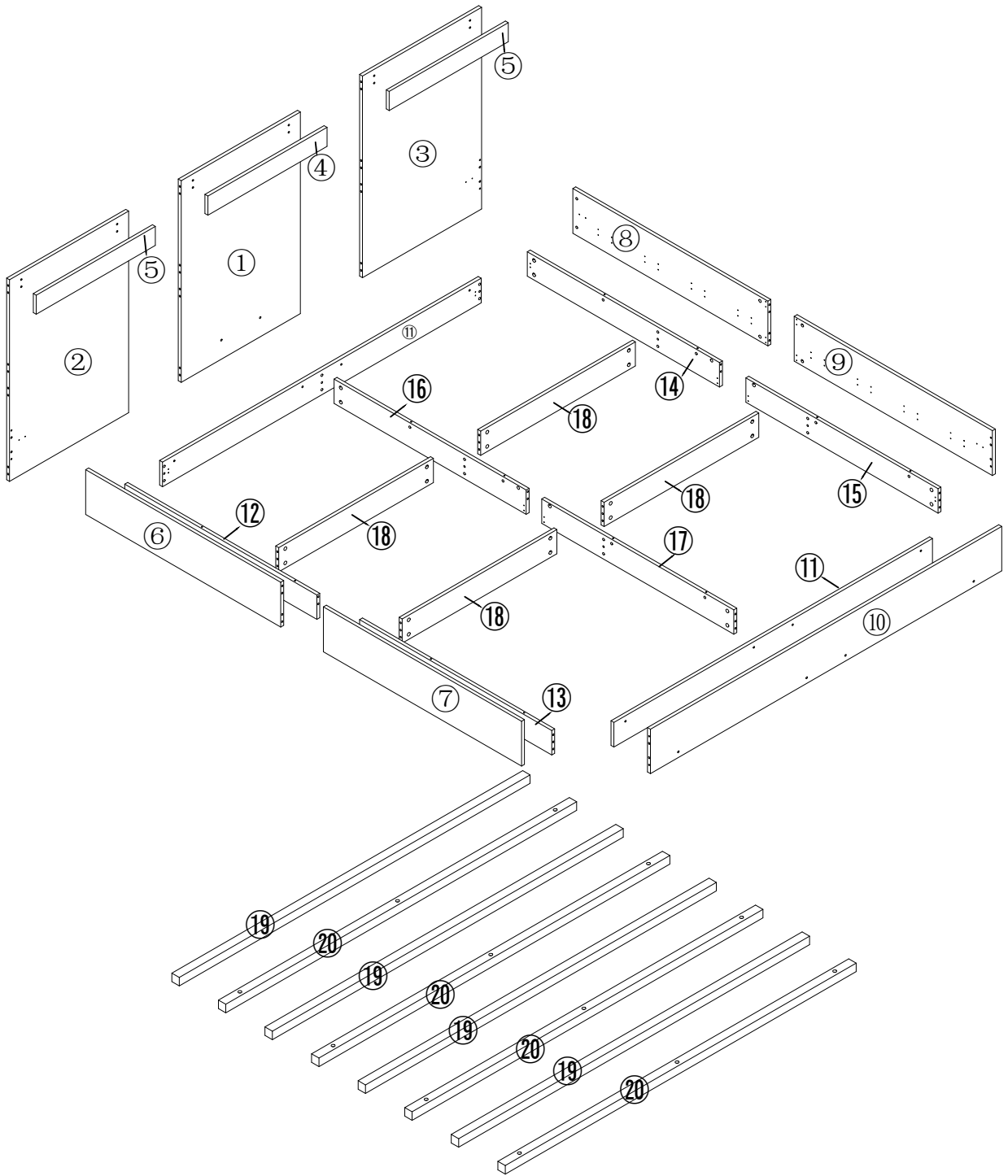

WF306825AAW

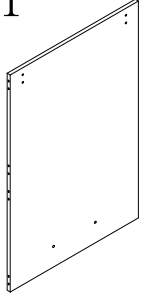
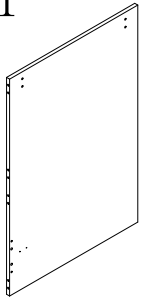
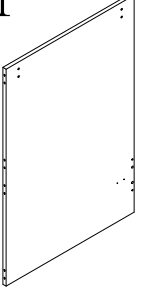
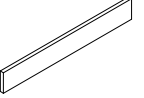
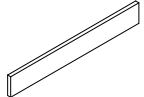
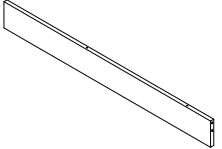
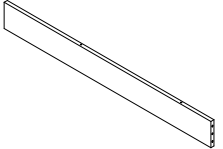
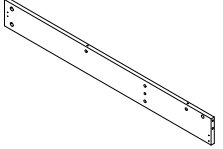
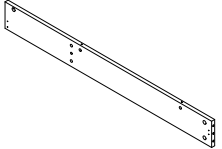
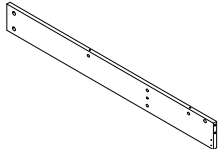
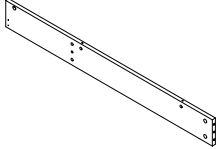
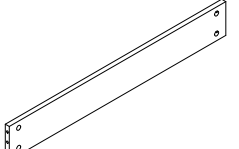
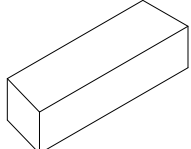

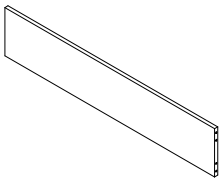
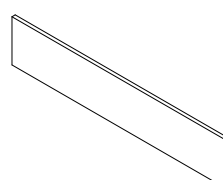
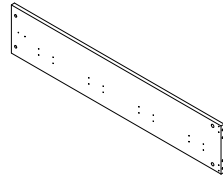
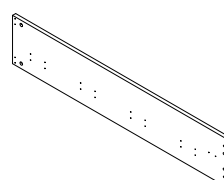
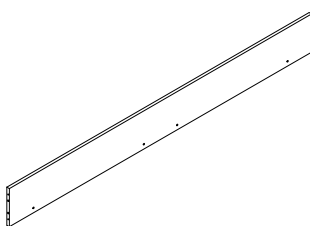
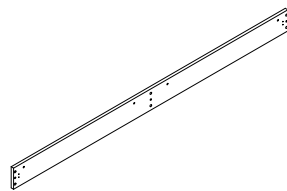
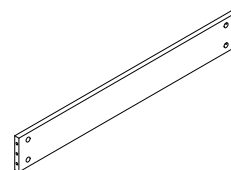
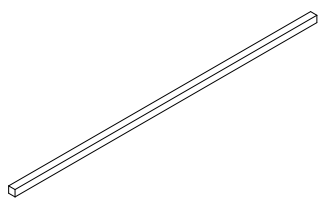
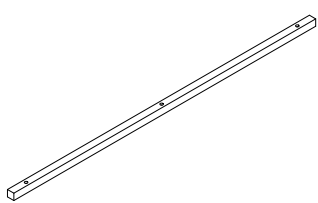

<p>①X1</p> 	<p>②X1</p> 	<p>③X1</p> 	<p>④X1</p> 
<p>⑤X2</p> 	<p>⑫X1</p> 	<p>⑬X1</p> 	<p>⑭X1</p> 
<p>⑮X1</p> 	<p>⑯X1</p> 	<p>⑰X1</p> 	<p>⑱X2</p> 
<p>X1</p>  <p>Hardware Box Ein metallkästchen</p>			

WF306826AAW

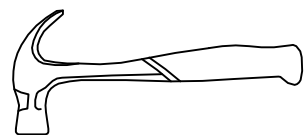
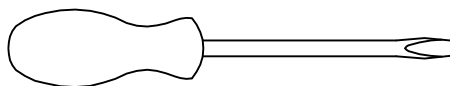
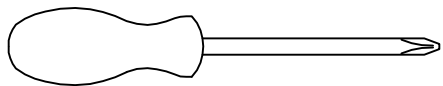
⑥X1 	⑦X1 	⑧X1 	⑨X1 
⑩X1 	⑪X2 	⑱X2 	⑲X4 
⑳X4 			

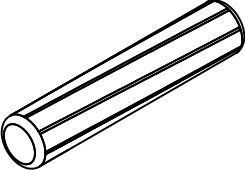
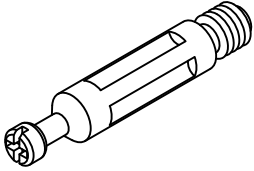
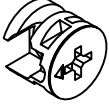
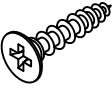
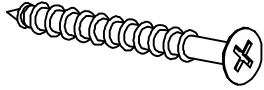

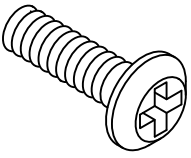
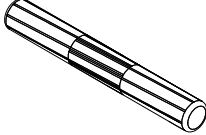
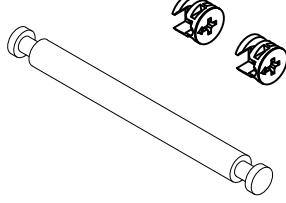
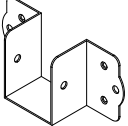
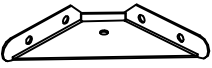
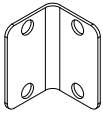
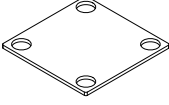
Tools Required (Not Included)

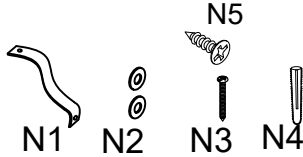

<p>A</p>  <p>$\Phi 8 \times 40 \text{MM}$ 18 pcs</p>	<p>B1</p>  <p>$\Phi 6 \times 40 \text{MM}$ 28 pcs</p>	<p>B2</p>  <p>$\Phi 15 \times 10 \text{MM}$ 28 pcs</p>
<p>C</p>  <p>$\Phi 3.5 \times 14 \text{MM}$ 180 pcs</p>	<p>D</p>  <p>$\Phi 5 \times 50 \text{MM}$ 20 pcs</p>	<p>E</p>  <p>$\Phi 10 \times 10 \text{MM}$ 20 pcs</p>
<p>F</p>  <p>$\Phi 6 \times 25 \text{MM}$ 20 pcs</p>	<p>G</p>  <p>$\Phi 8 \times 60 \text{MM}$ 17 pcs</p>	<p>H</p>  <p>$\Phi 15 \times 10 \text{MM}$ 15 sets</p>
<p>J</p>  <p>16 pcs</p>	<p>K</p>  <p>4 pcs</p>	<p>L</p>  <p>4 pcs</p>
<p>R</p>  <p>13 pcs</p>	<p>S</p>  <p>35 pcs</p>	<p>T</p>  <p>25 pcs</p>
<p>N</p>  <p>2 pcs</p>		

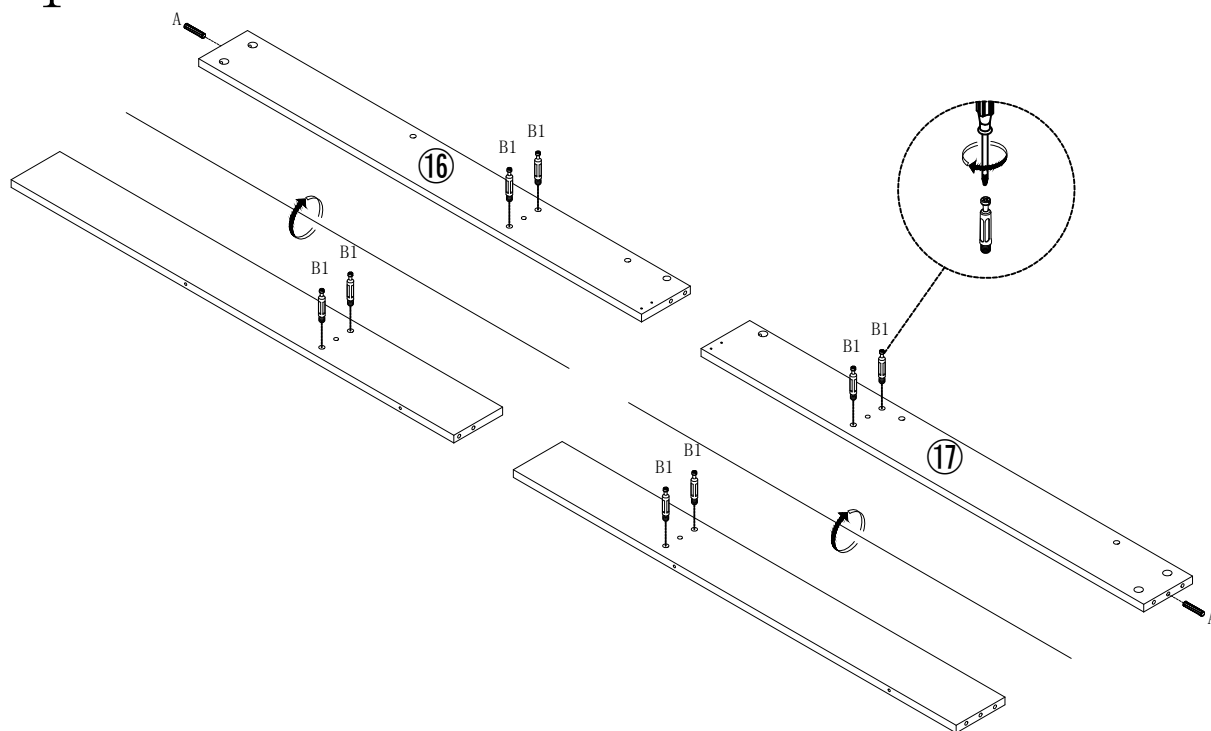



STEP 1

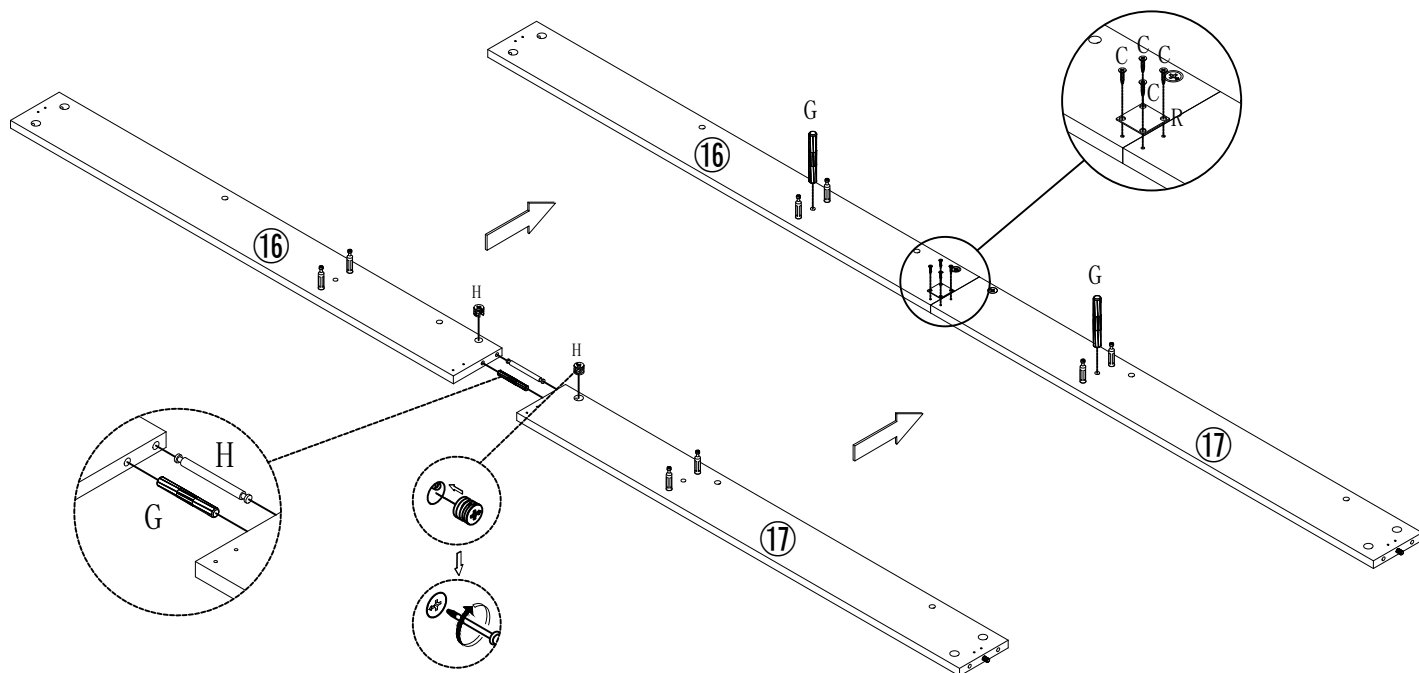

	Ax2pcs		B1x8pcs
--	--------	---	---------

STEP 2



	Cx4pcs		Gx3pcs		Hx1sets		Rx1pc
--	--------	---	--------	---	---------	---	-------

STEP 3

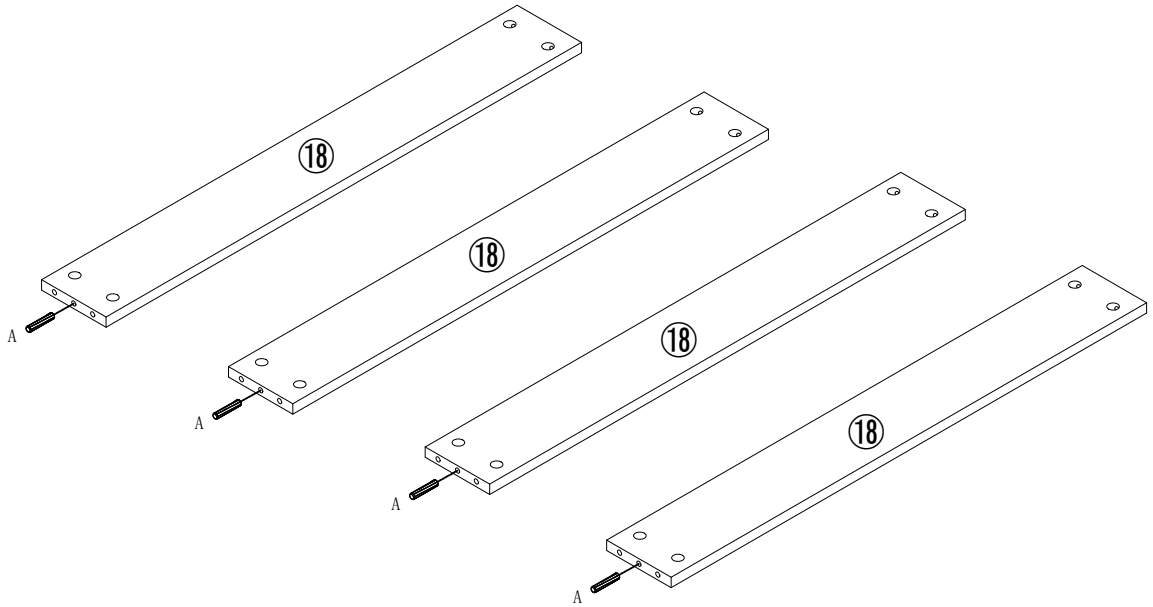

Ax4pcs

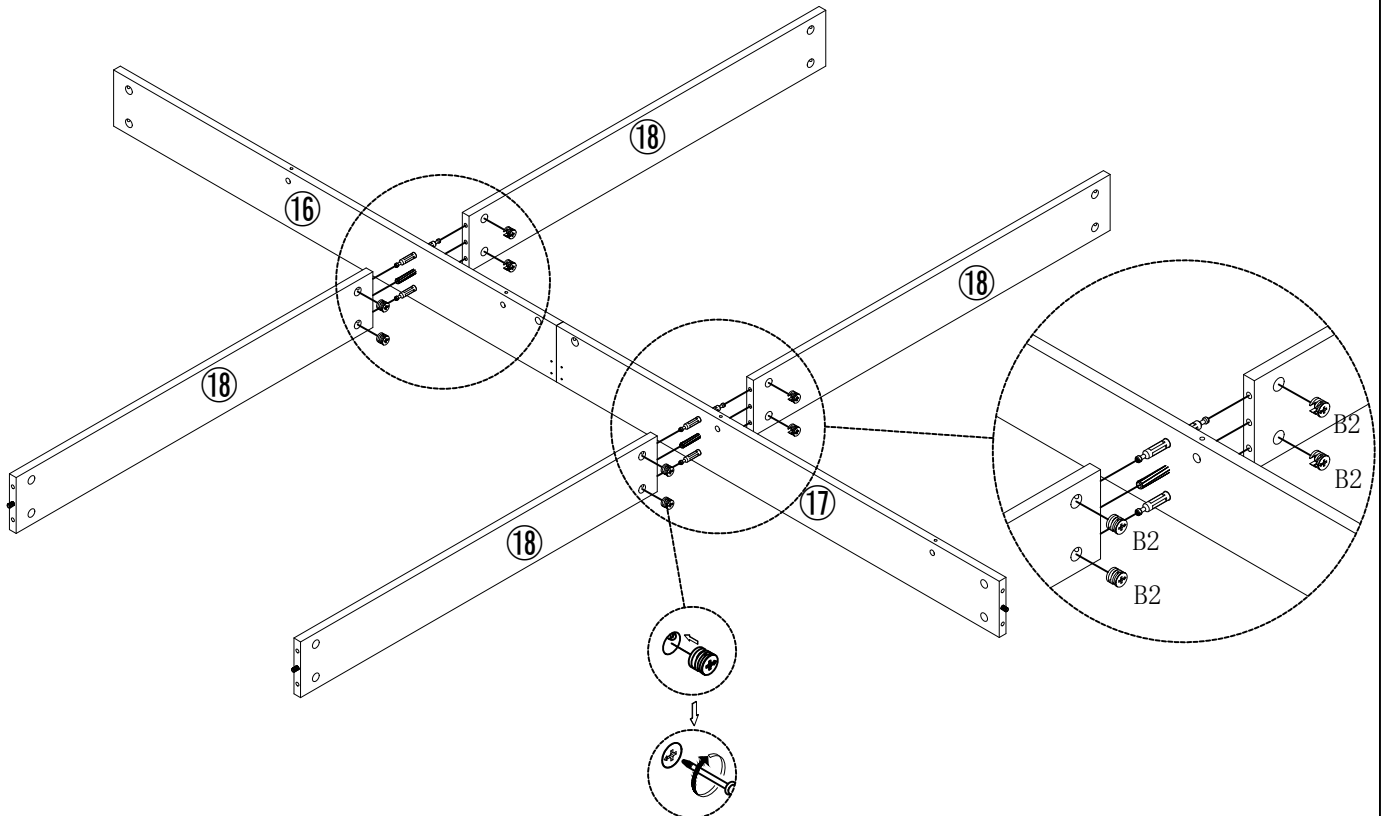

STEP 4

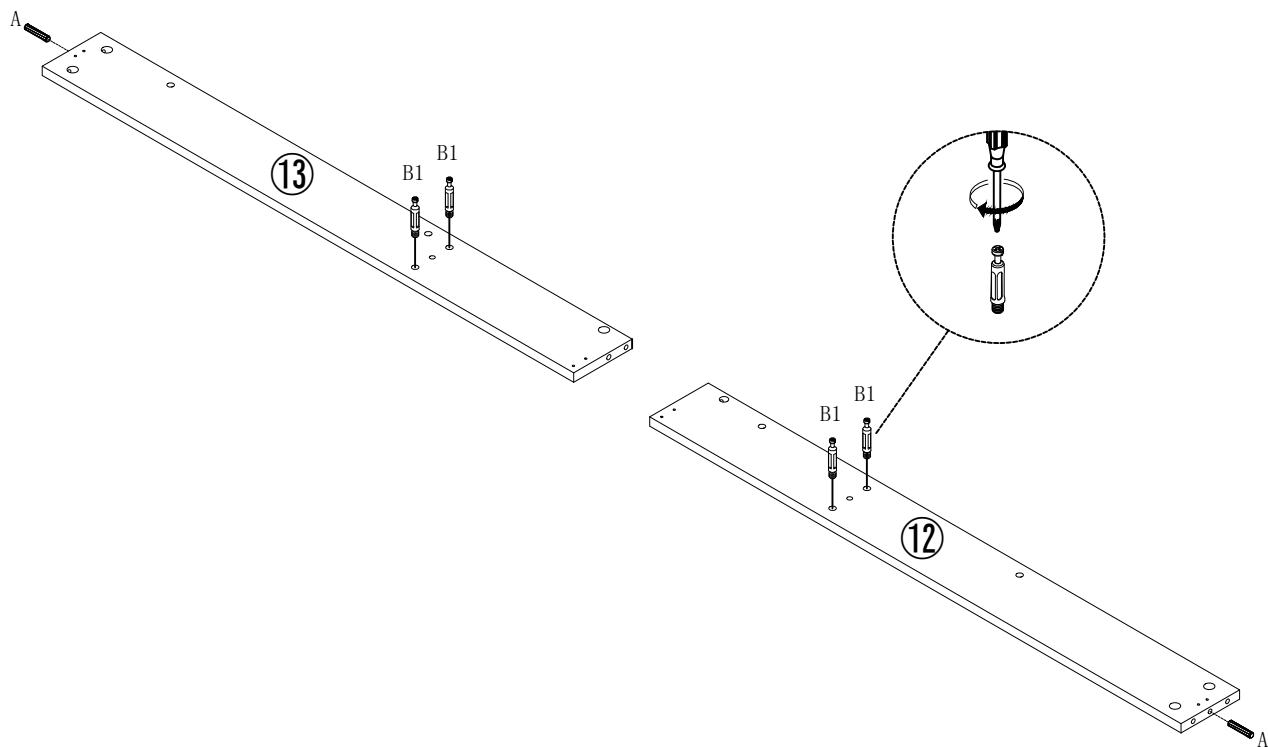

B2x8pcs

STEP 5



	Ax2pcs		B1x4pcs
--	--------	---	---------

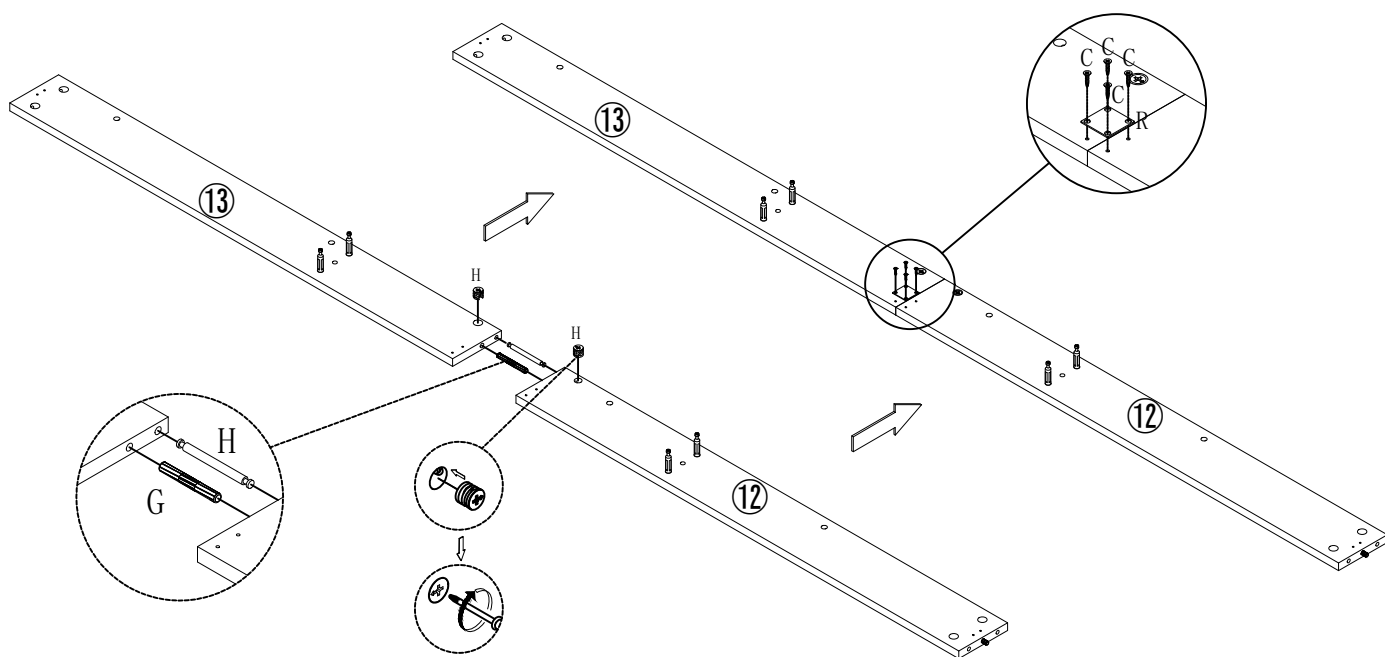

STEP 6

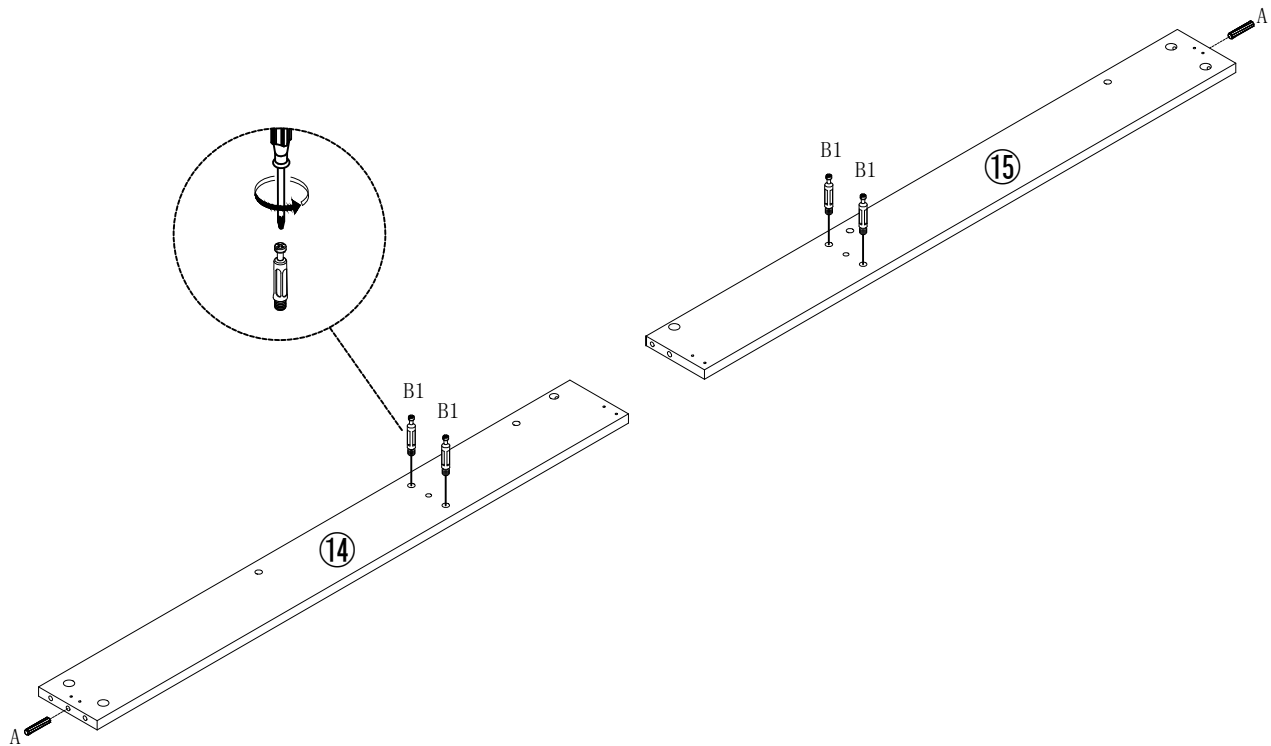

	Cx4pcs		Hx1sets		Rx1pc		Gx1pc
--	--------	---	---------	---	-------	---	-------

STEP 7



	Ax2pcs		B1x4pcs
--	--------	---	---------

STEP 8

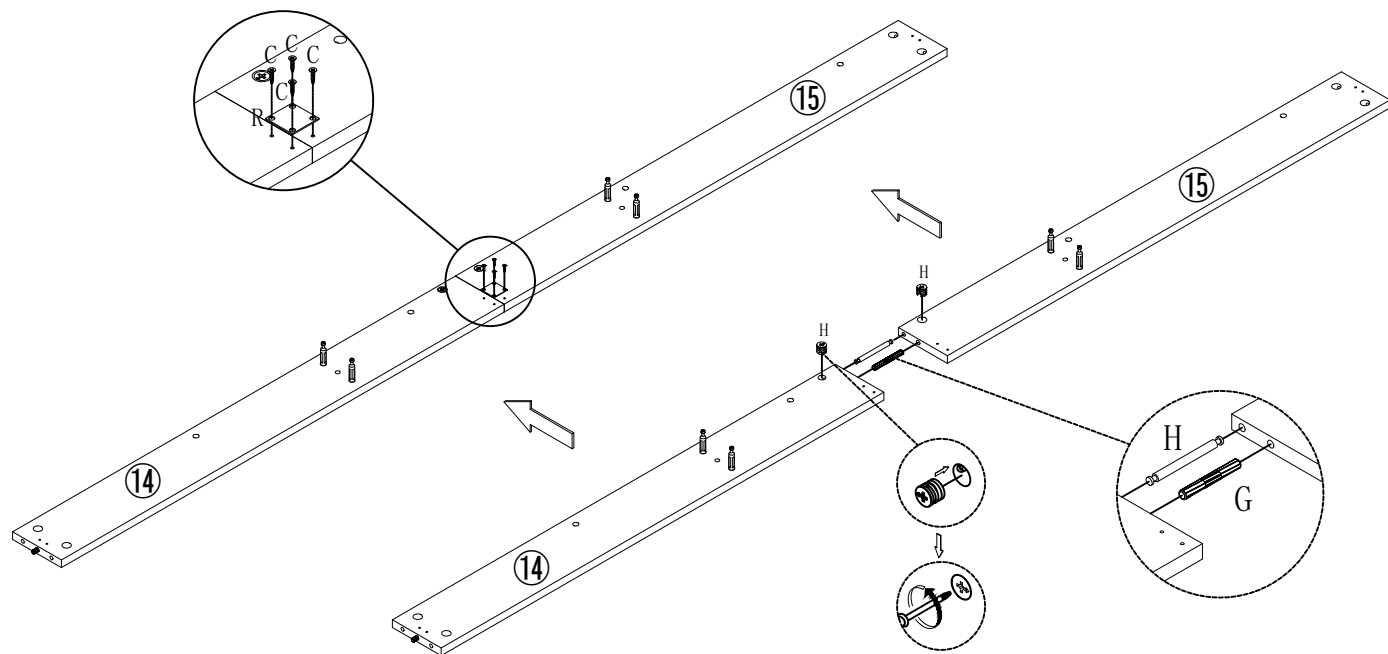

	Cx4pcs		Hx1sets		Rx1pc		Gx1pc
--	--------	---	---------	---	-------	---	-------

STEP 9

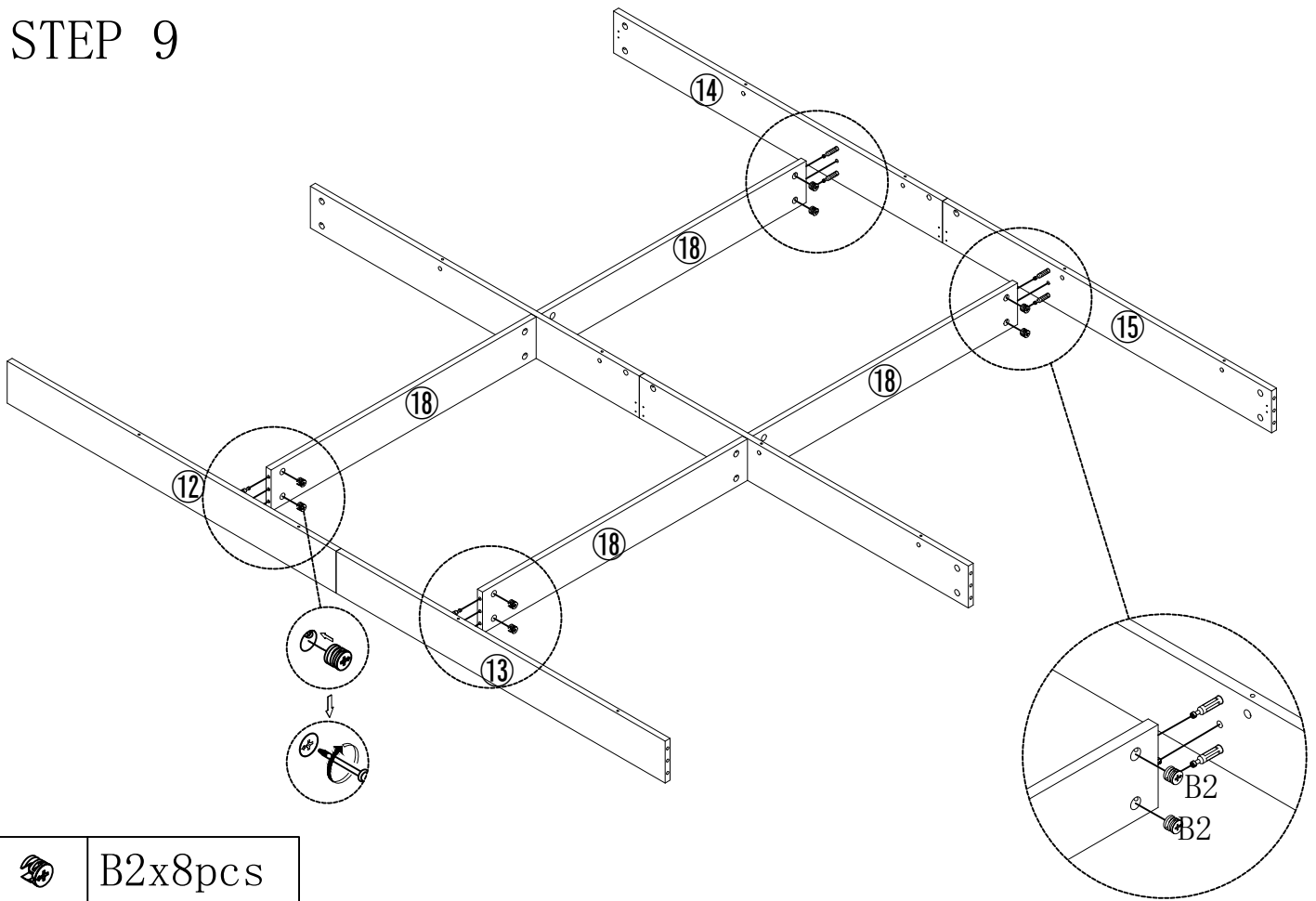

STEP 10

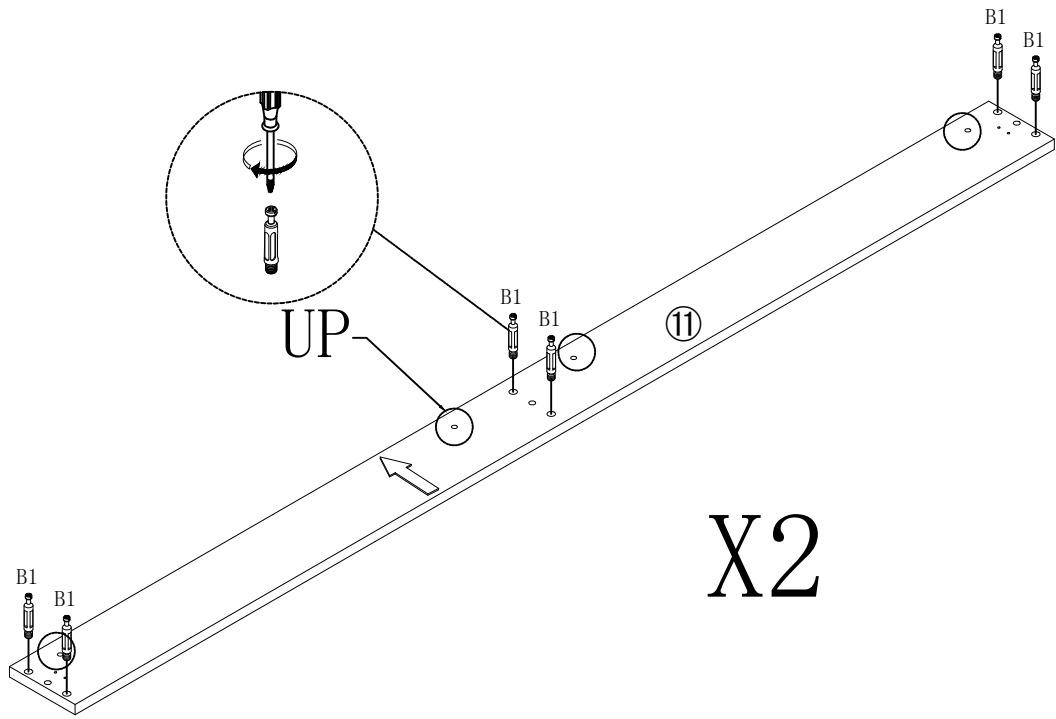

 B1x12pcs

STEP 11

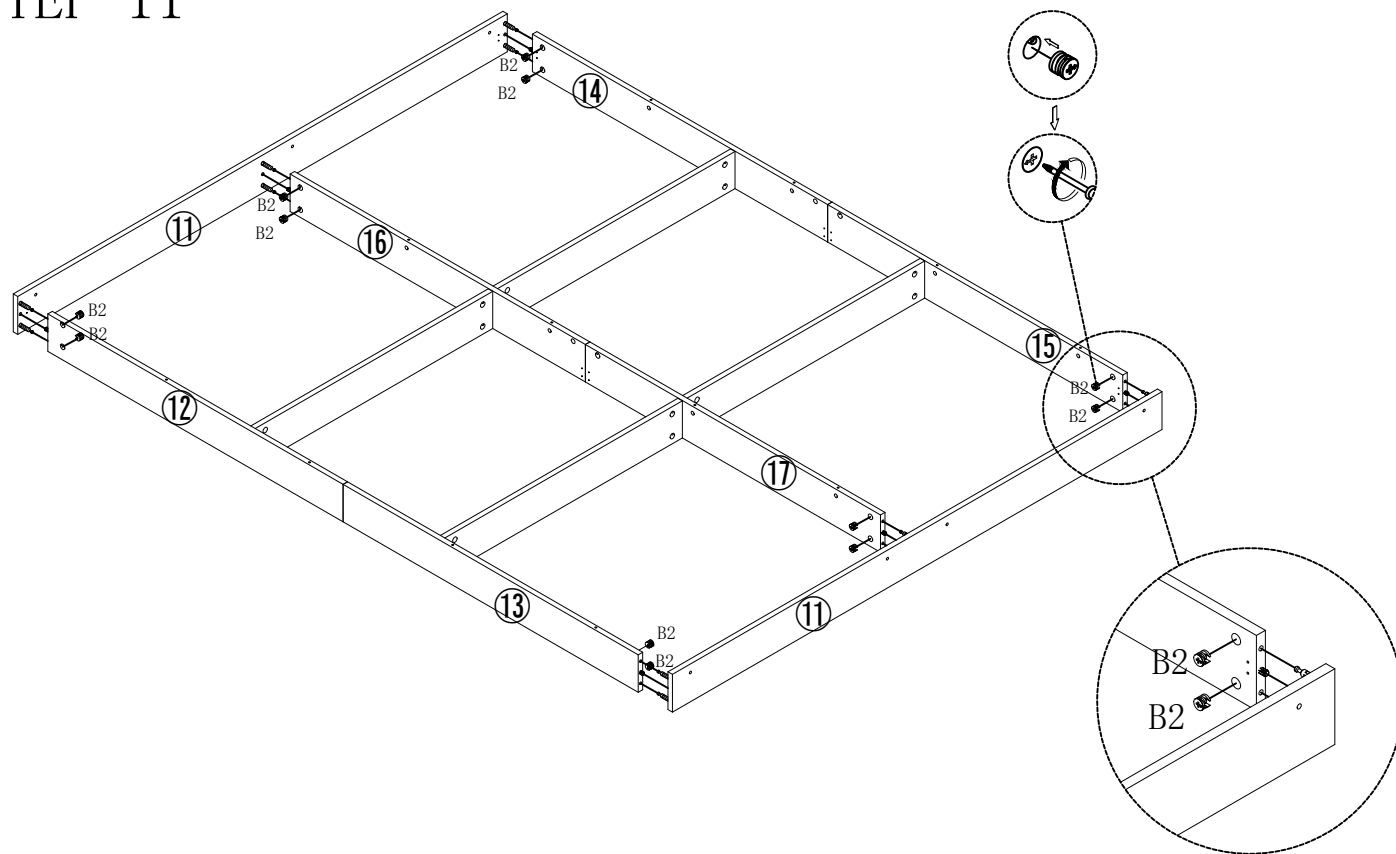

B2x12pcs

STEP 12

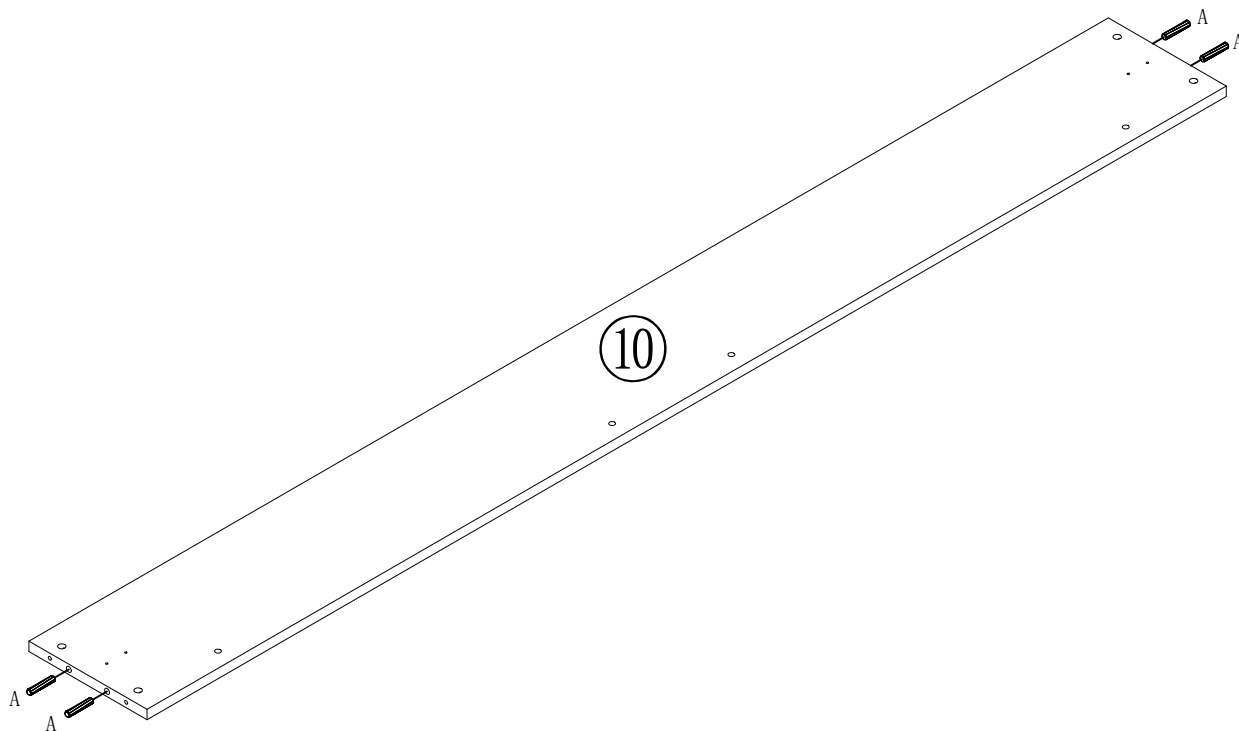

Ax4pcs

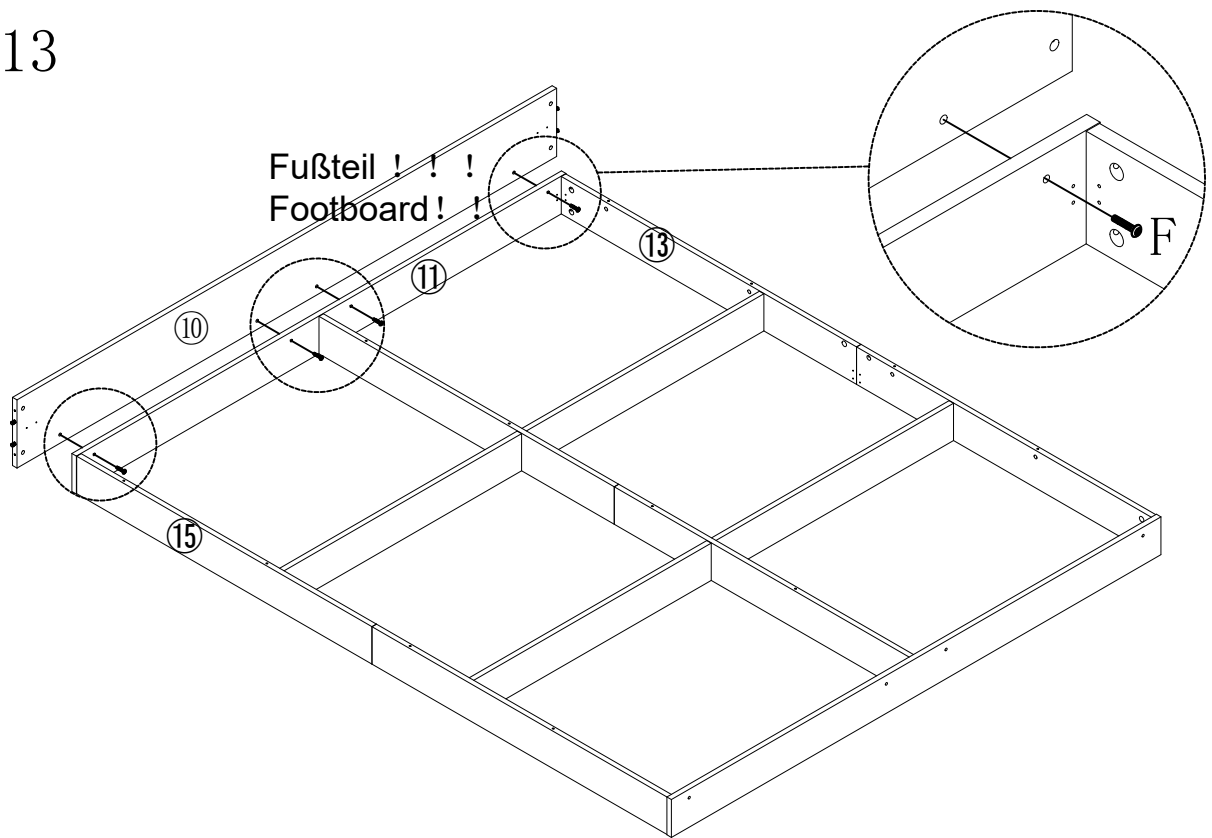

STEP 13

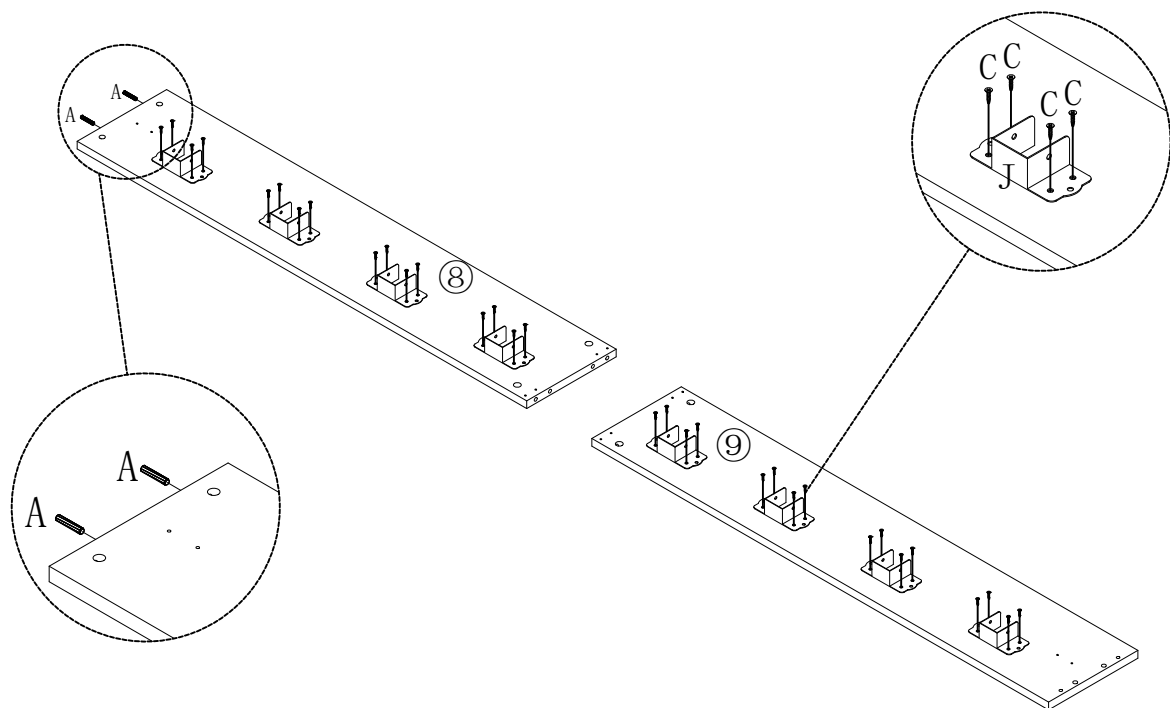

	Fx4pcs
--	--------

STEP 14



	Cx32pcs		Jx8pcs		Ax2pcs
--	---------	---	--------	---	--------

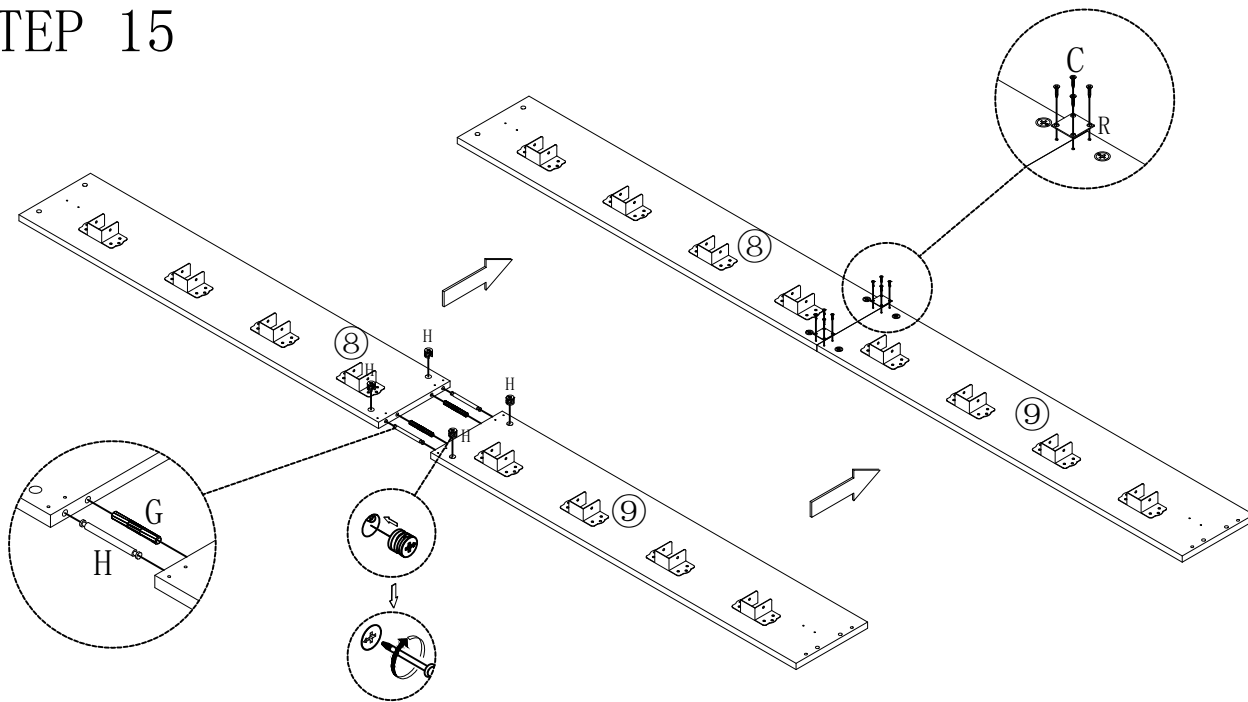

STEP 15



	Cx8pcs		Hx2sets		Rx2pcs		Gx2pcs
--	--------	---	---------	---	--------	---	--------

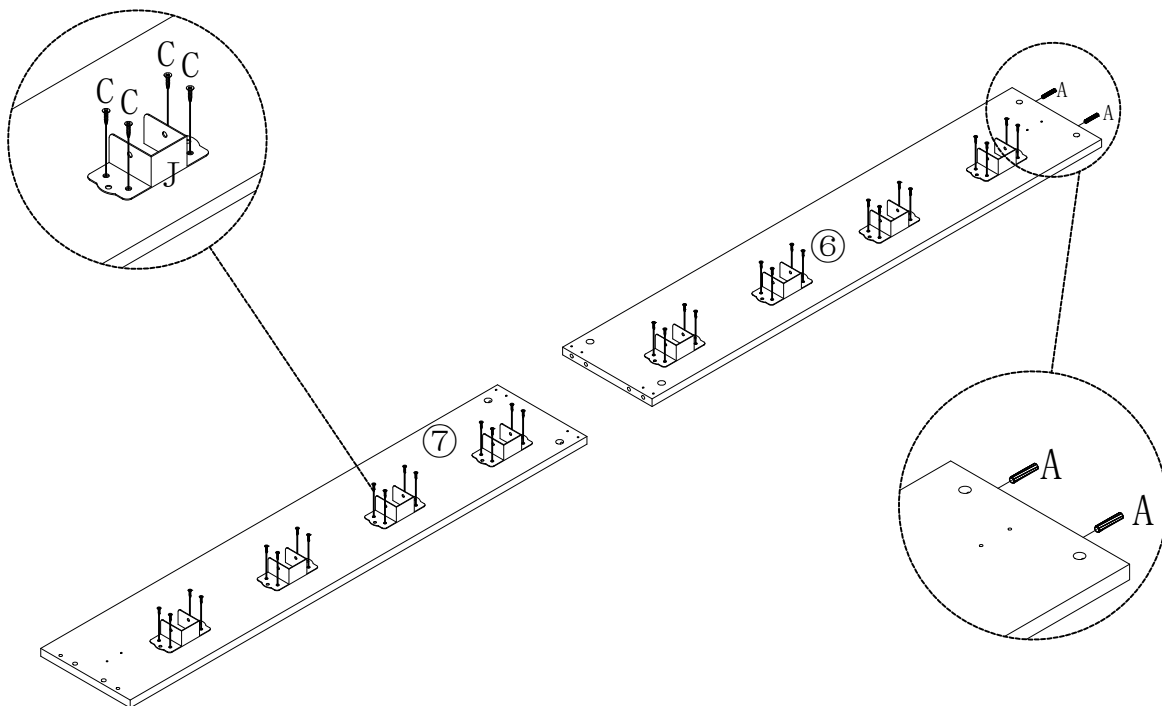



STEP 16

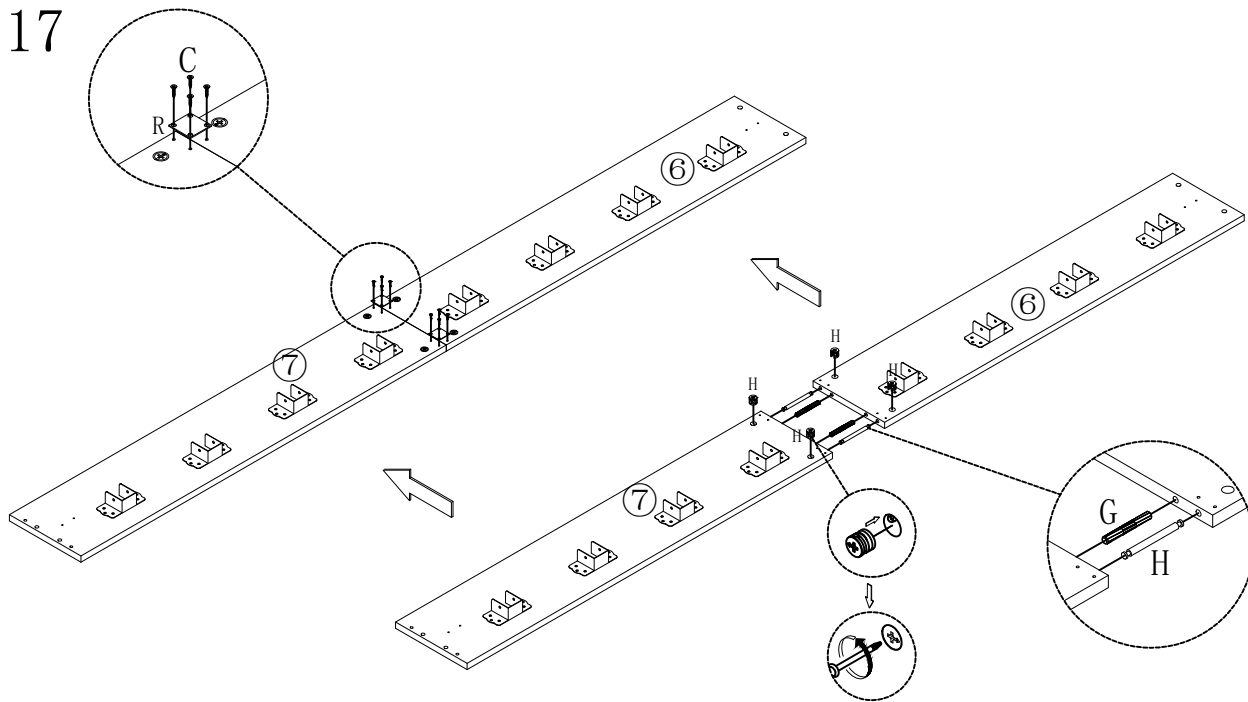

	Cx32pcs		Jx8pcs		Ax2pcs
--	---------	---	--------	---	--------



STEP 17



	Cx8pcs		Hx2sets		Rx2pcs		Gx2pcs
--	--------	---	---------	---	--------	---	--------

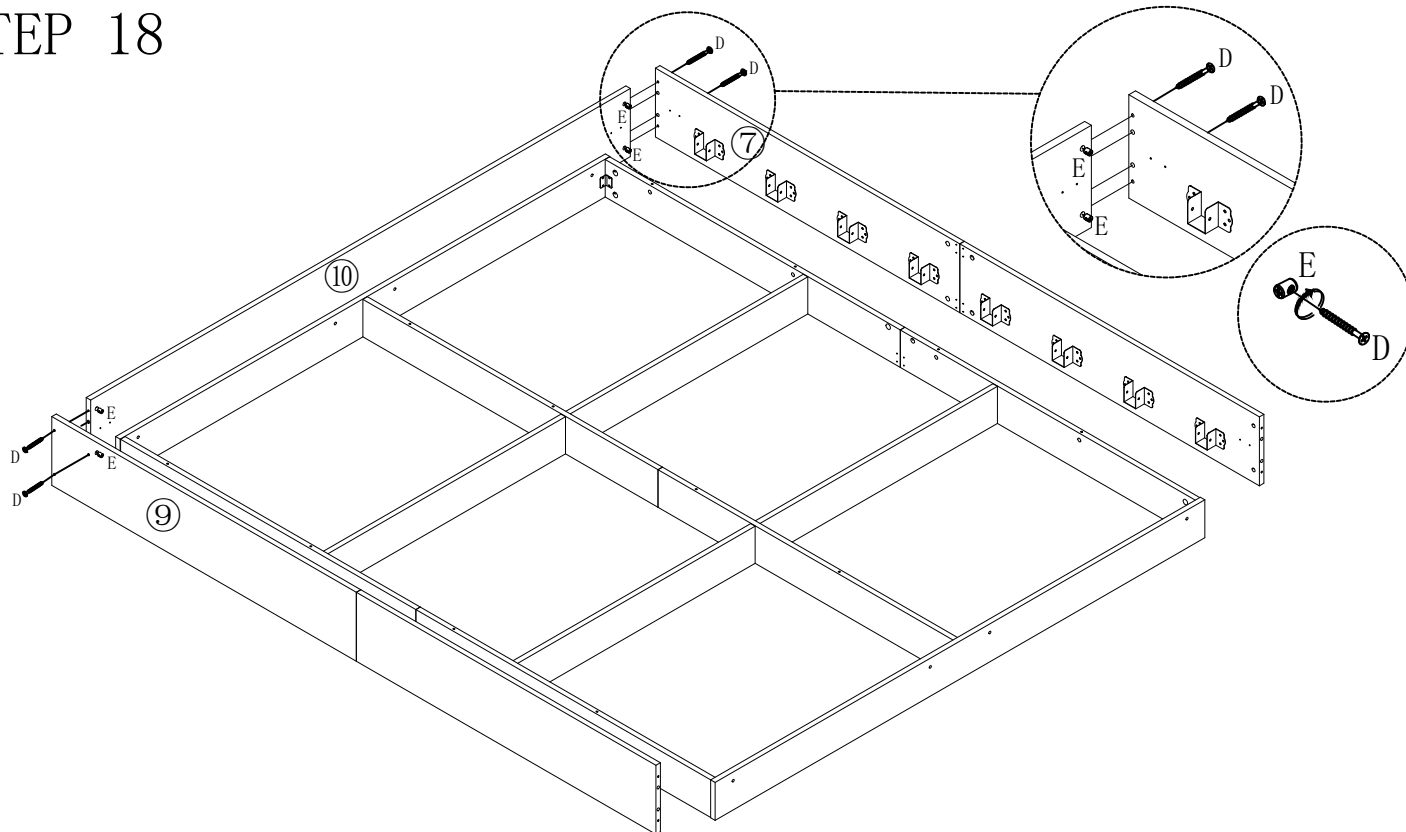

STEP 18



	Dx4pcs		Ex4pcs
--	--------	---	--------

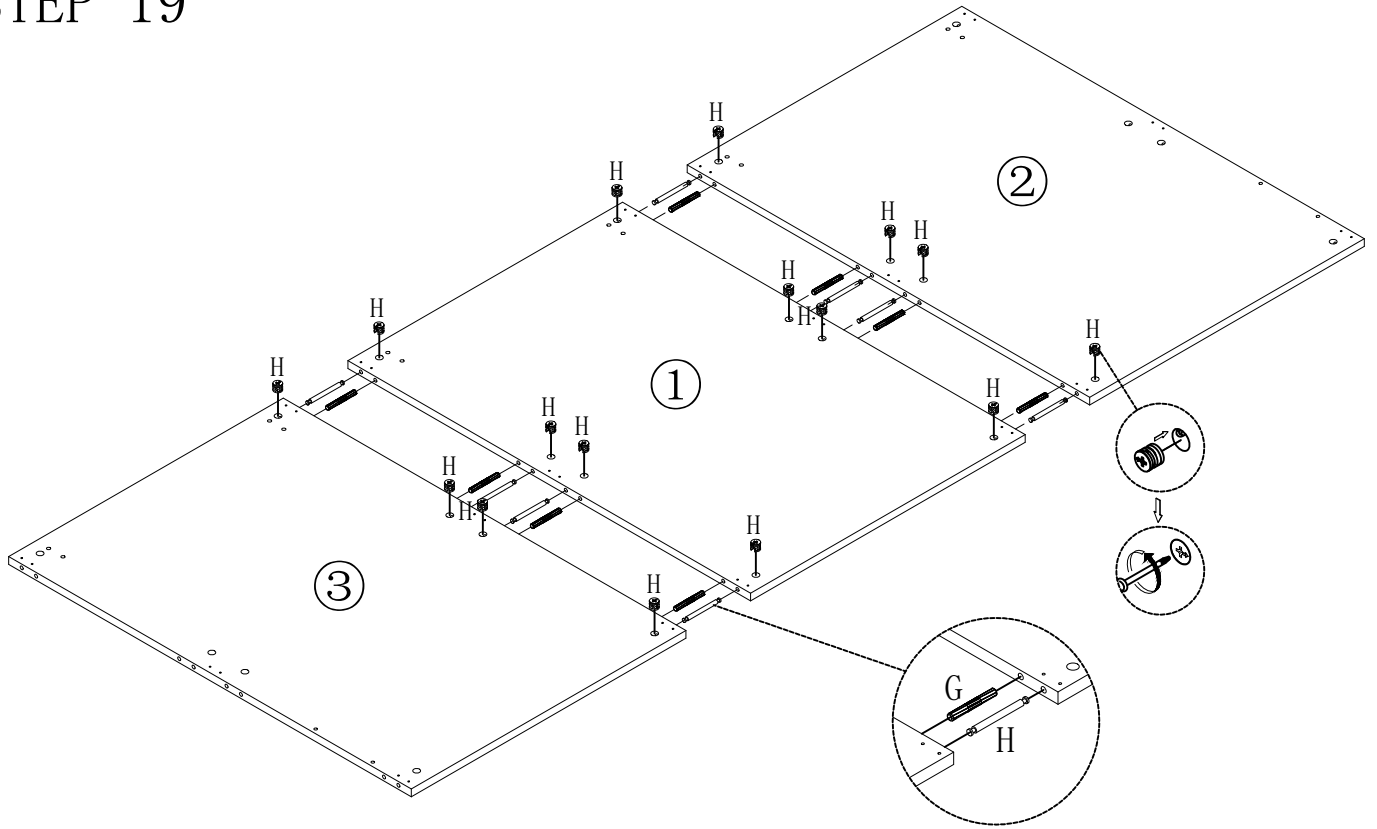

STEP 19

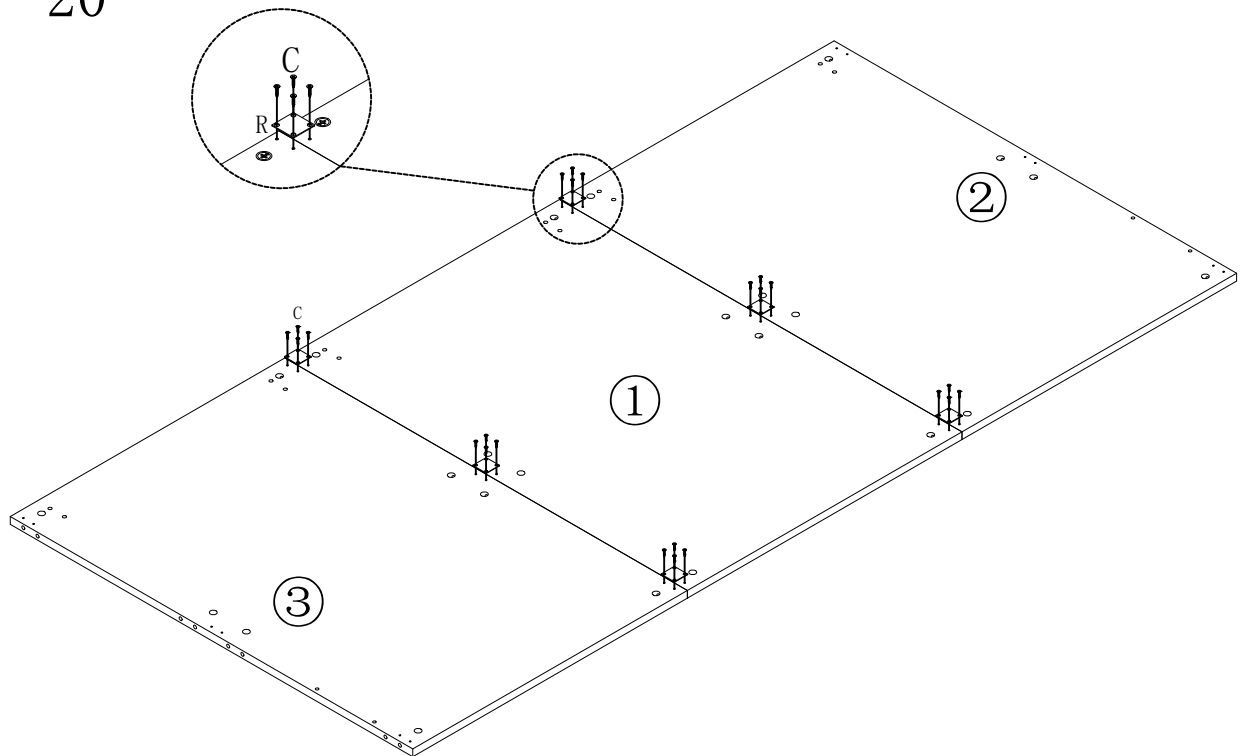

	Hx8sets		Gx8pcs
--	---------	---	--------

STEP 20



	Cx24pcs		Rx6pcs
--	---------	---	--------

STEP 21

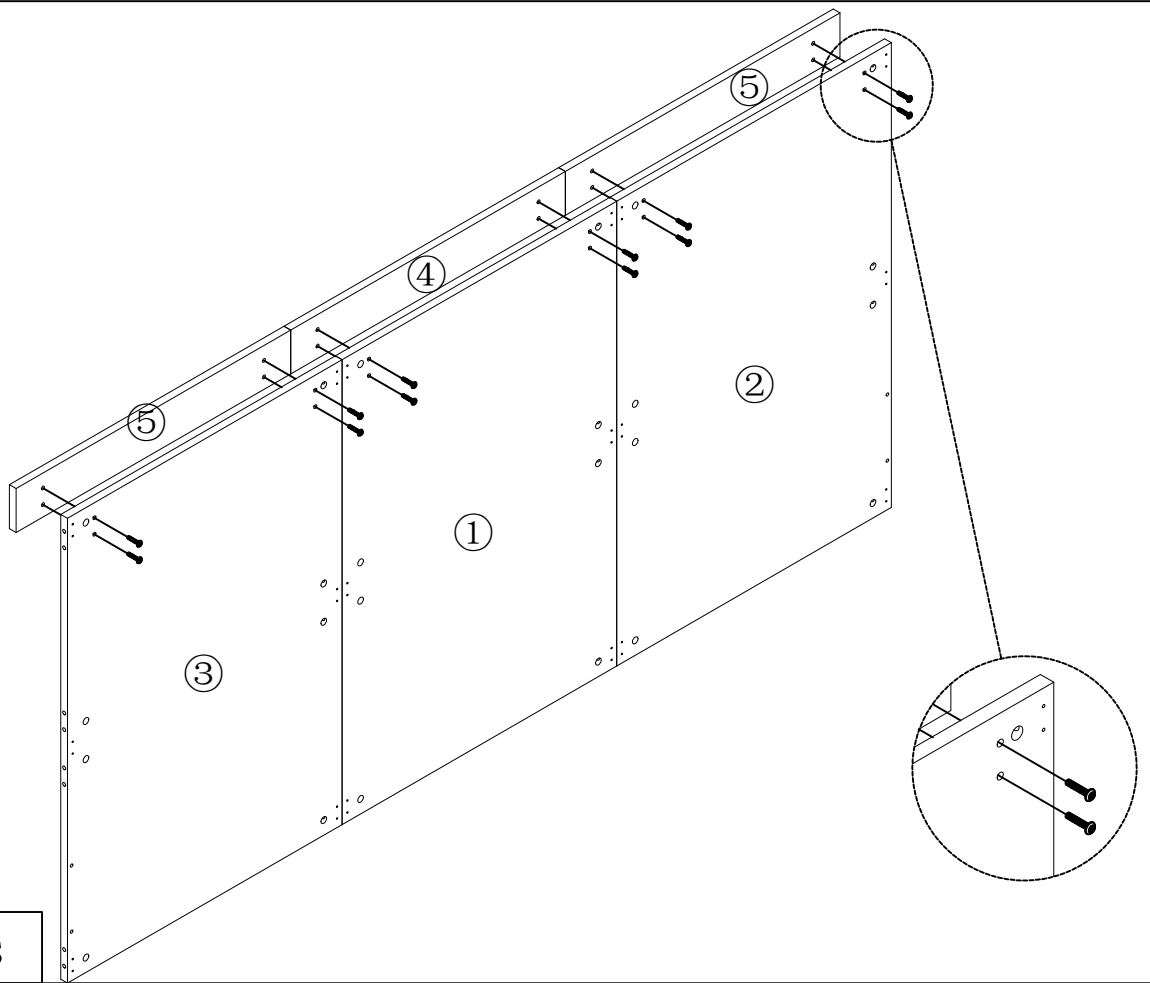

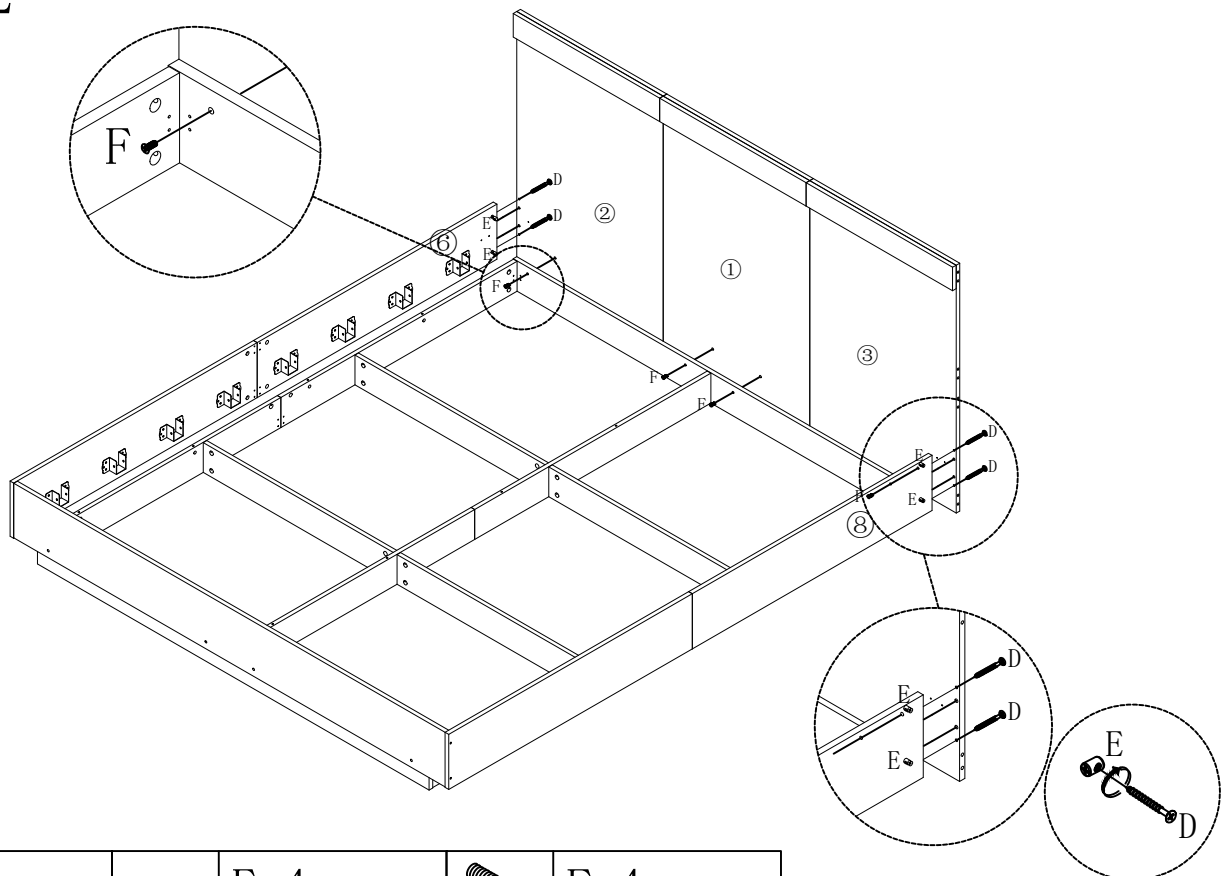

STEP 22



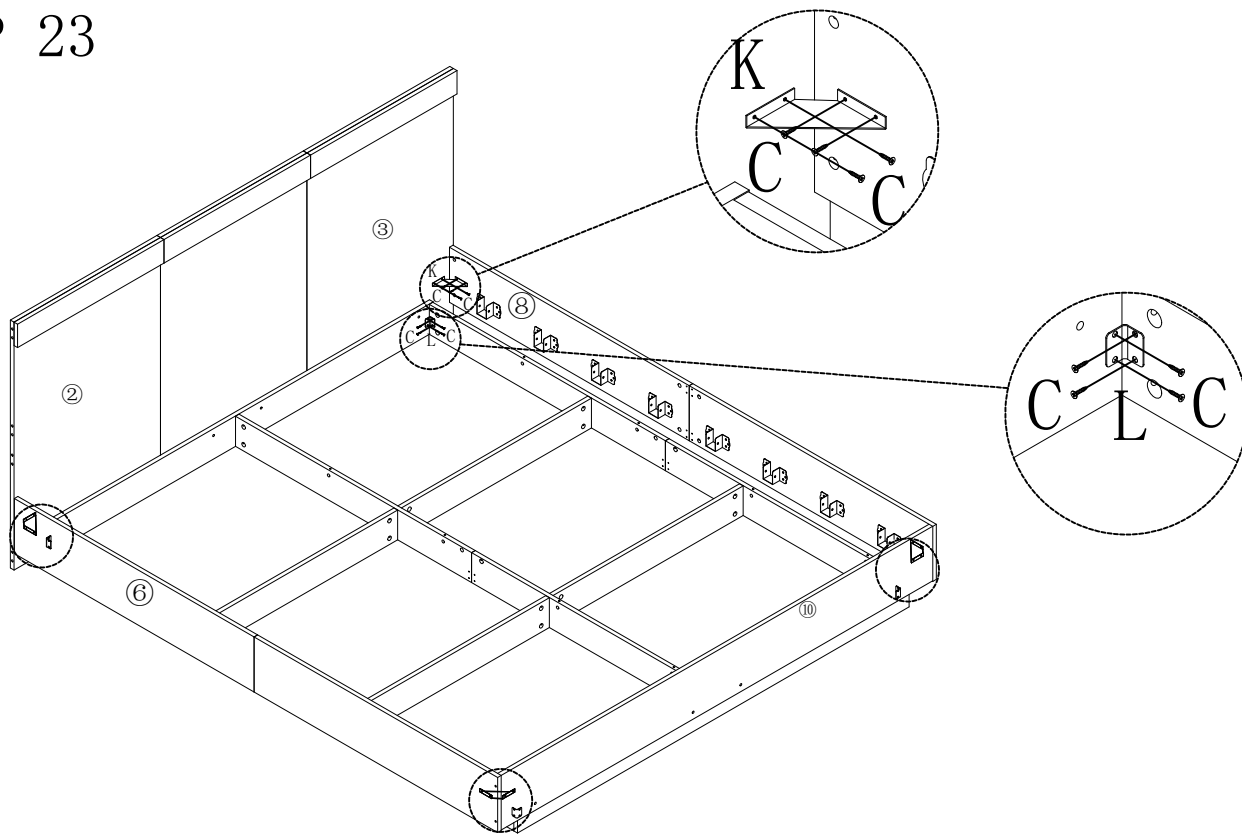

STEP 23



	Cx32pcs		Kx4pcs		Lx4pcs
--	---------	---	--------	---	--------

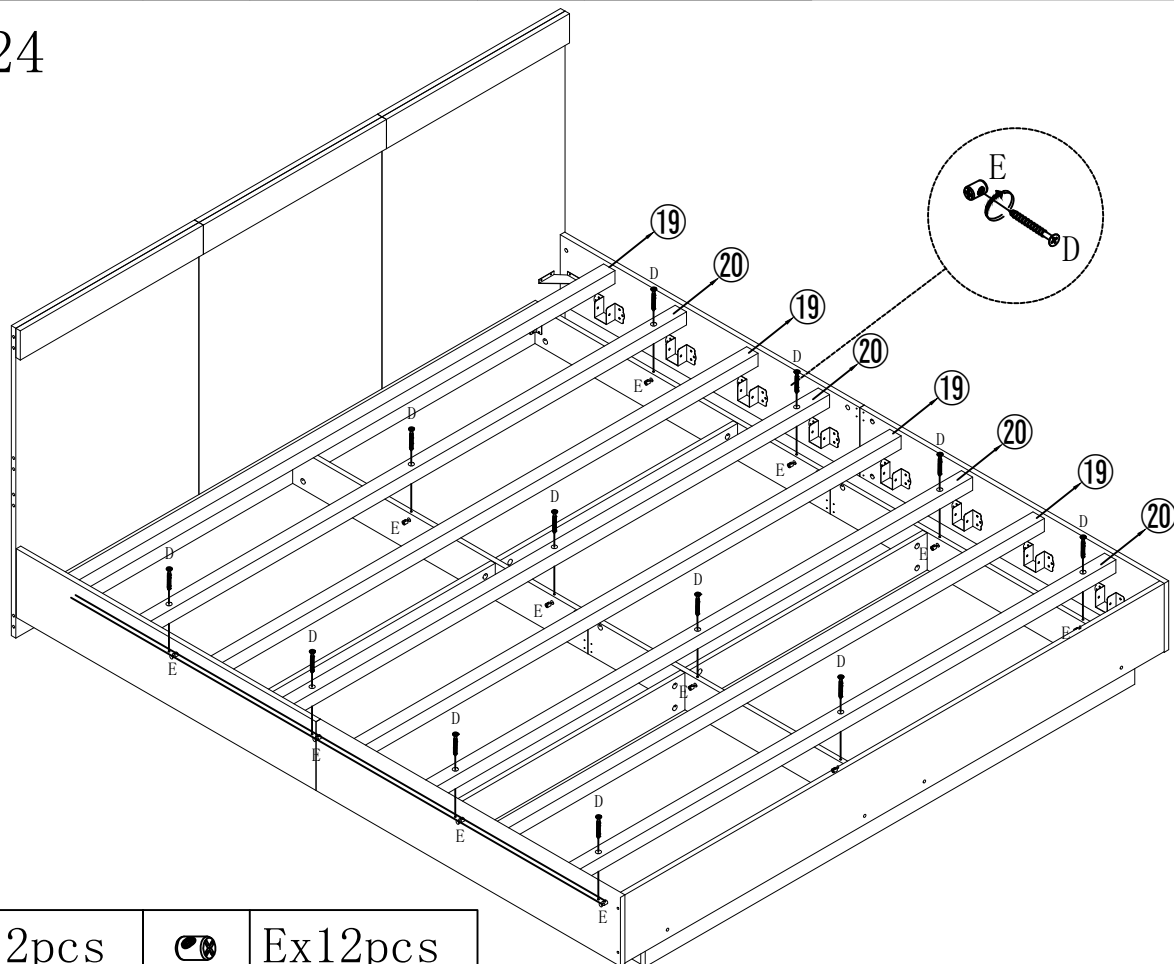

STEP 24

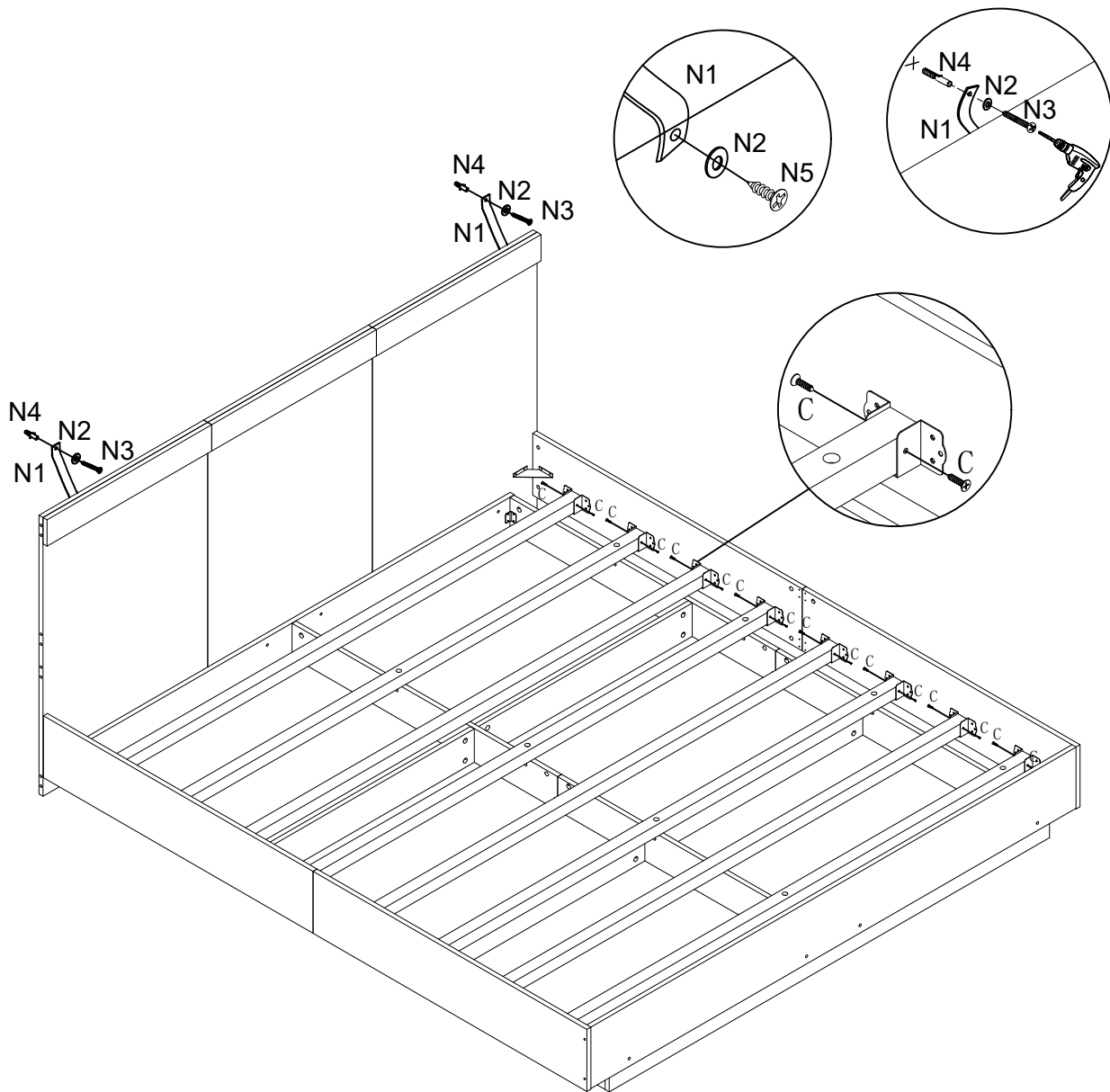

	Dx12pcs		Ex12pcs
--	---------	---	---------

STEP 25



	Cx32pcs
	Nx2pcs

STEP 26

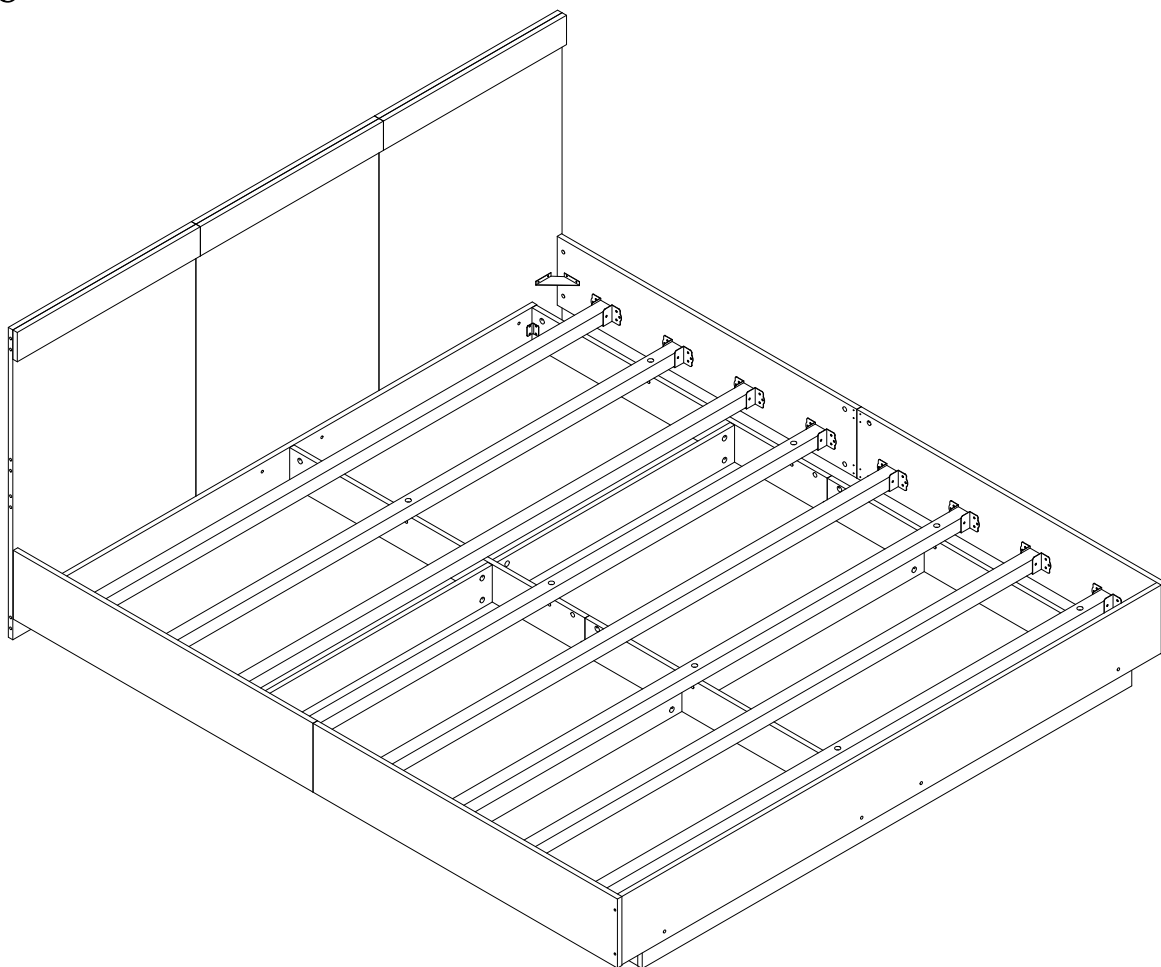

Tip: You can nicely cover screws and make your furniture more integrated with our screw stickers. This is not a necessary installation step, it all depends on your needs.

Tipp: Sie können die Schrauben schön abdecken und Ihre Möbel mit unseren Schraubenaufklebern besser integrieren, dies ist kein notwendiger Installationsschritt, sondern hängt ganz von Ihren Bedürfnissen ab.

Conseil : vous pouvez recouvrir les vis et rendre vos meubles plus intégrés grâce à nos autocollants pour vis.