









ASSEMBLY INSTRUCTION

Thank you for purchasing this quality product! Make sure all components and small hardware parts are included in the package before you start to assembly the products.

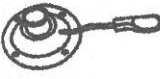
COMPONENTS LIST						HARDWARE LIST		
Serial No.	Description and Drawing	Quantity	Serial No.	Description and Drawing	Quantity	Serial No.	Description and Drawing	Quantity
1		X1	4		X1	7		X5
2		X1	5		X1			
3		X1	6		X1			

Serial No.	Description and Drawing	Quantity
A		X1
B		X4

NOTE:

STEP 1

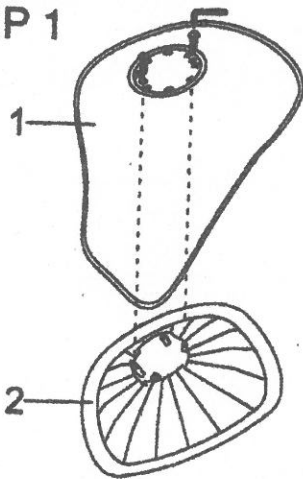

STEP 2

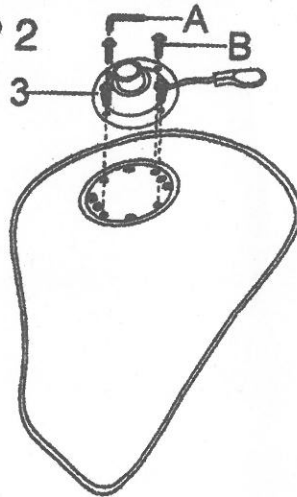

STEP 3

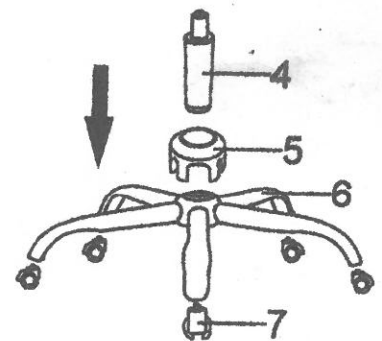

STEP 4

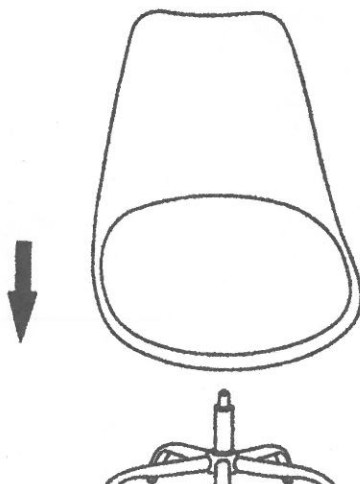

FINISHED

