

#	MENGE
1	1
2	1
3	1
4	1
5	1
6	1
7	1
8	1

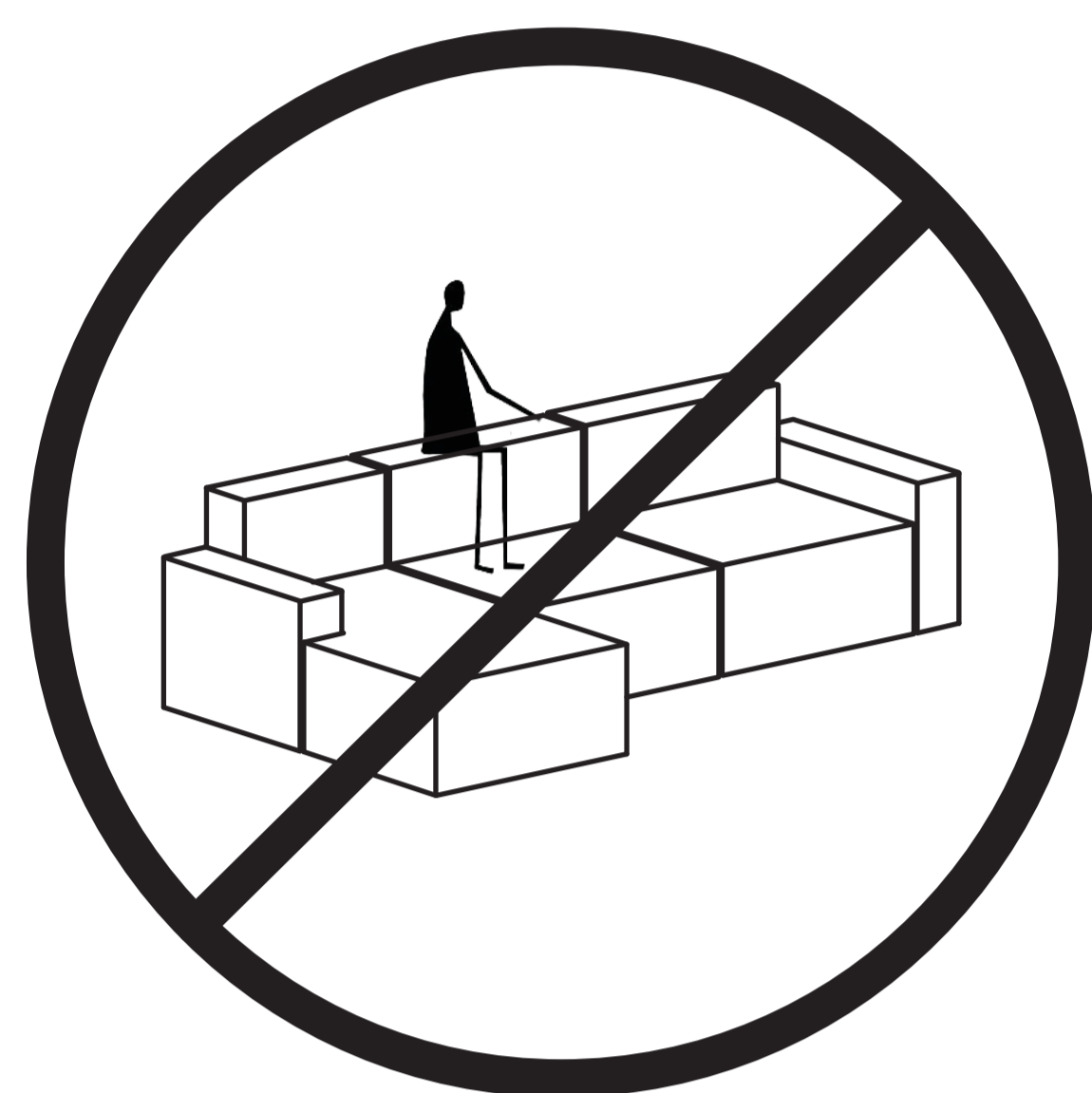

2

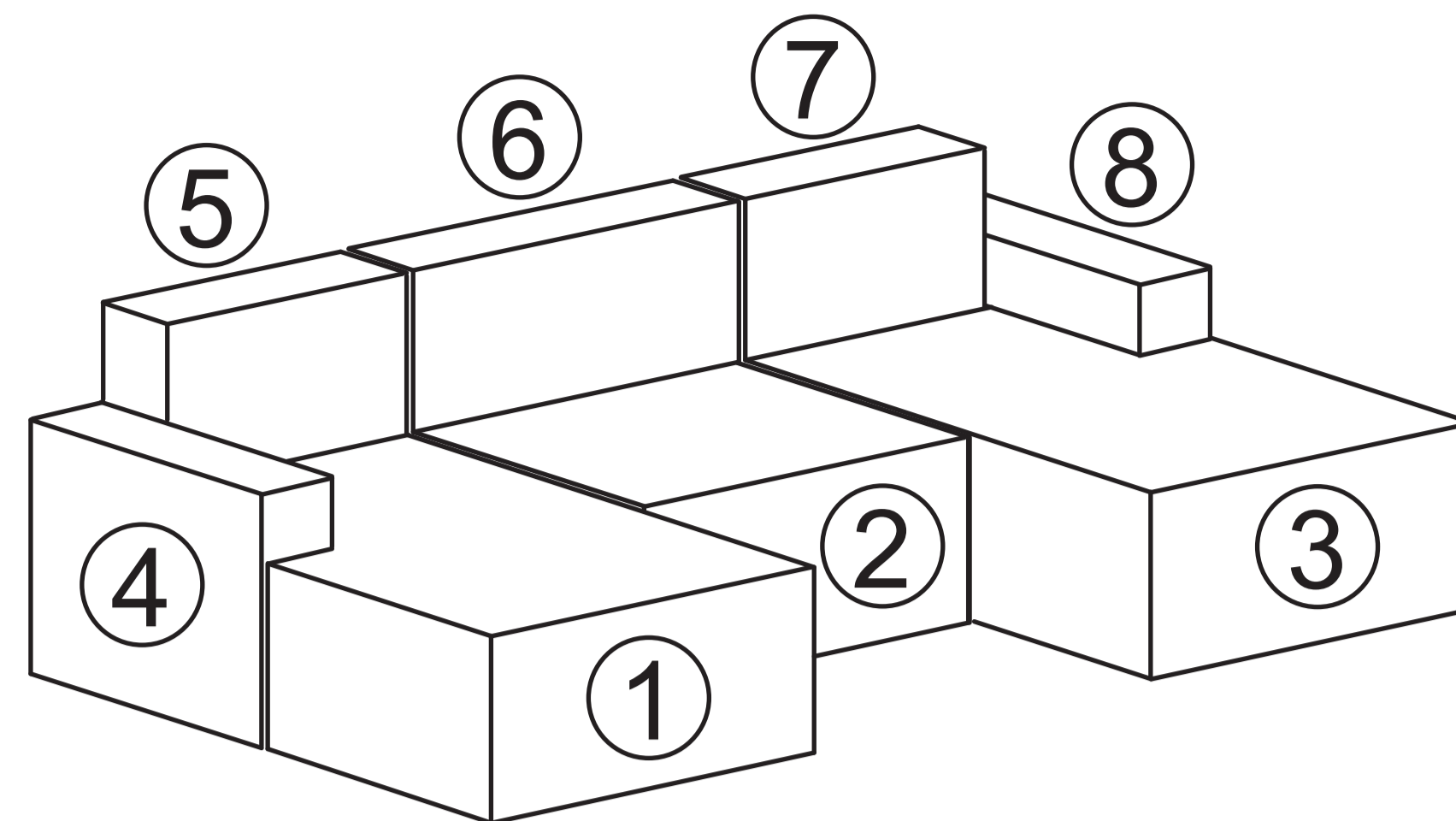
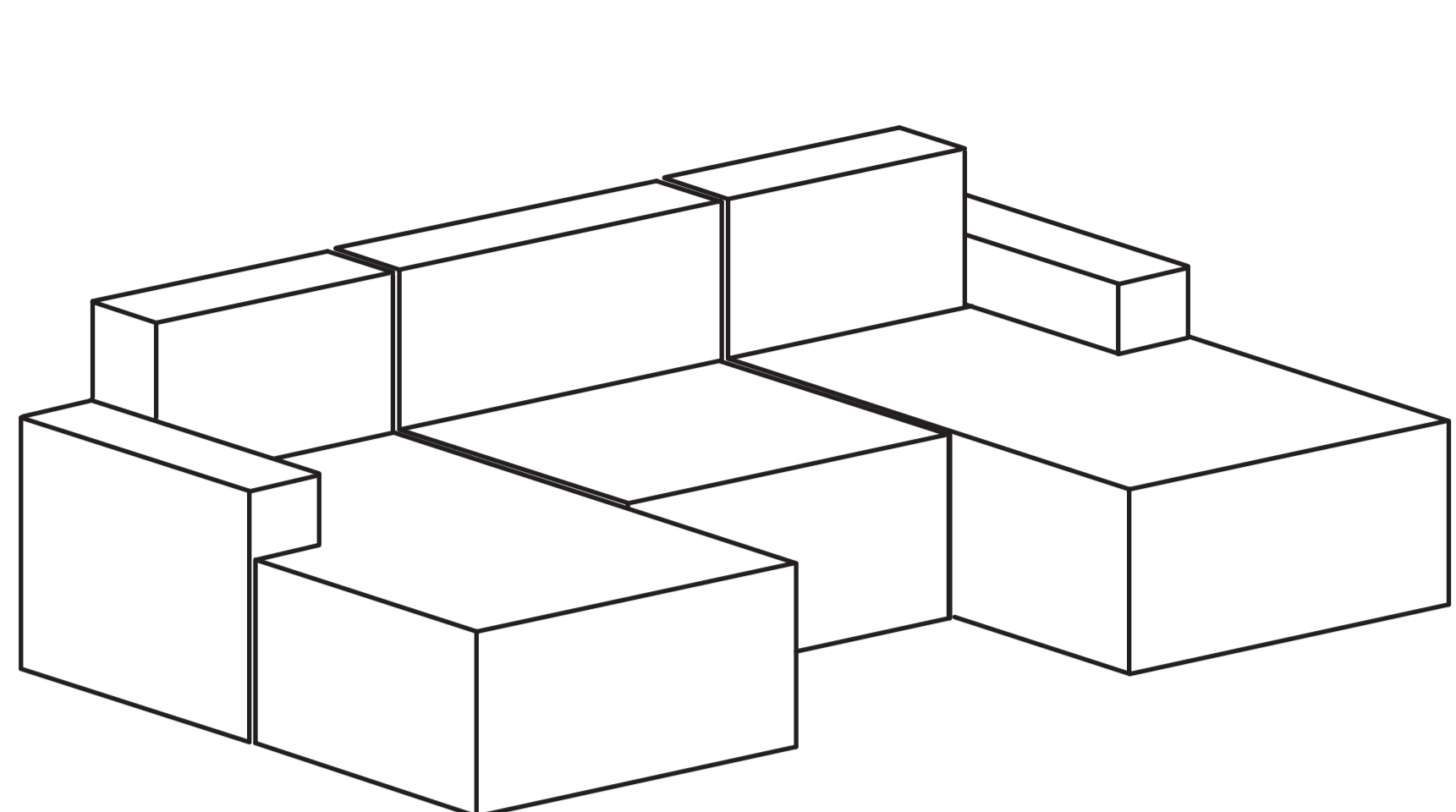
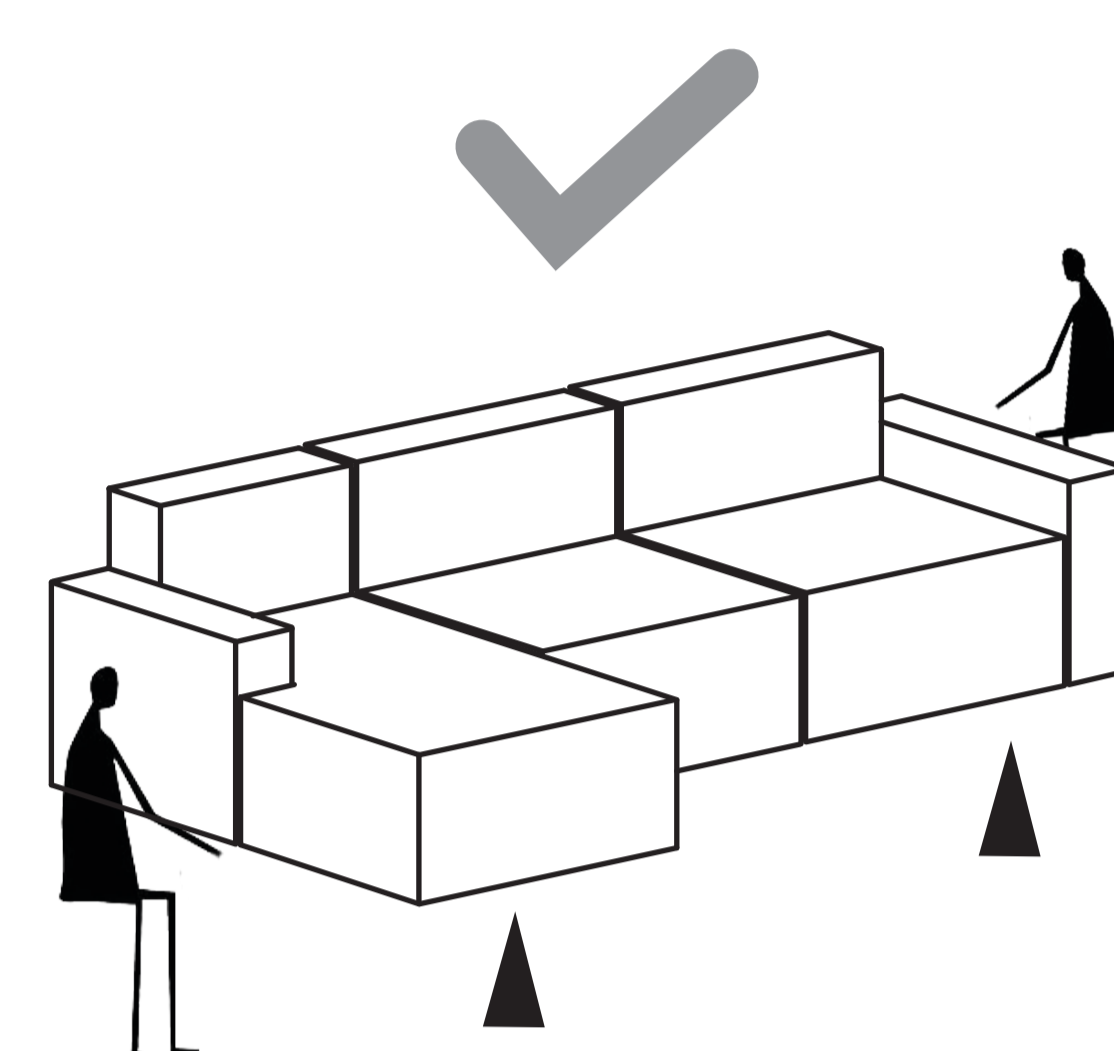
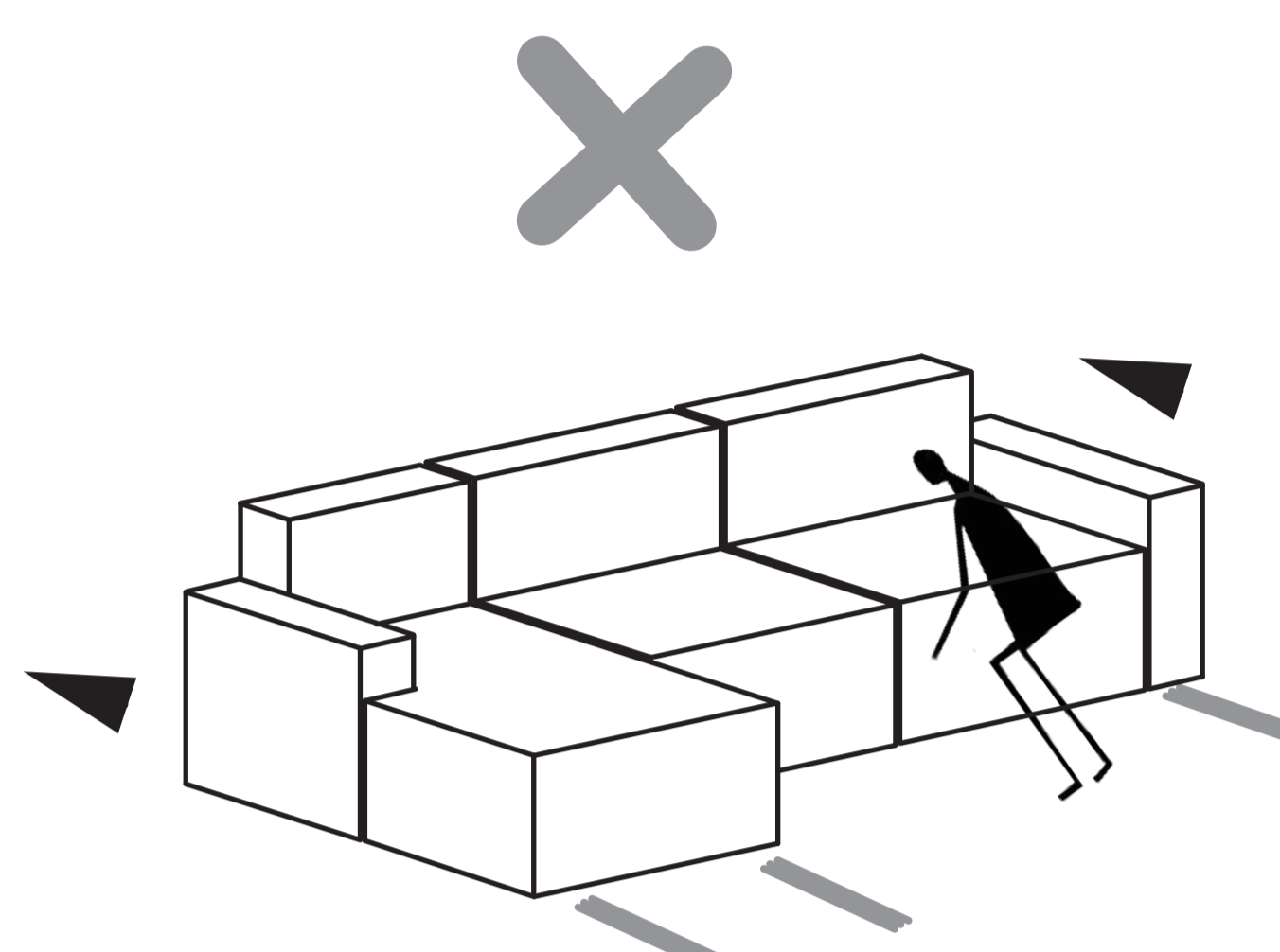

1

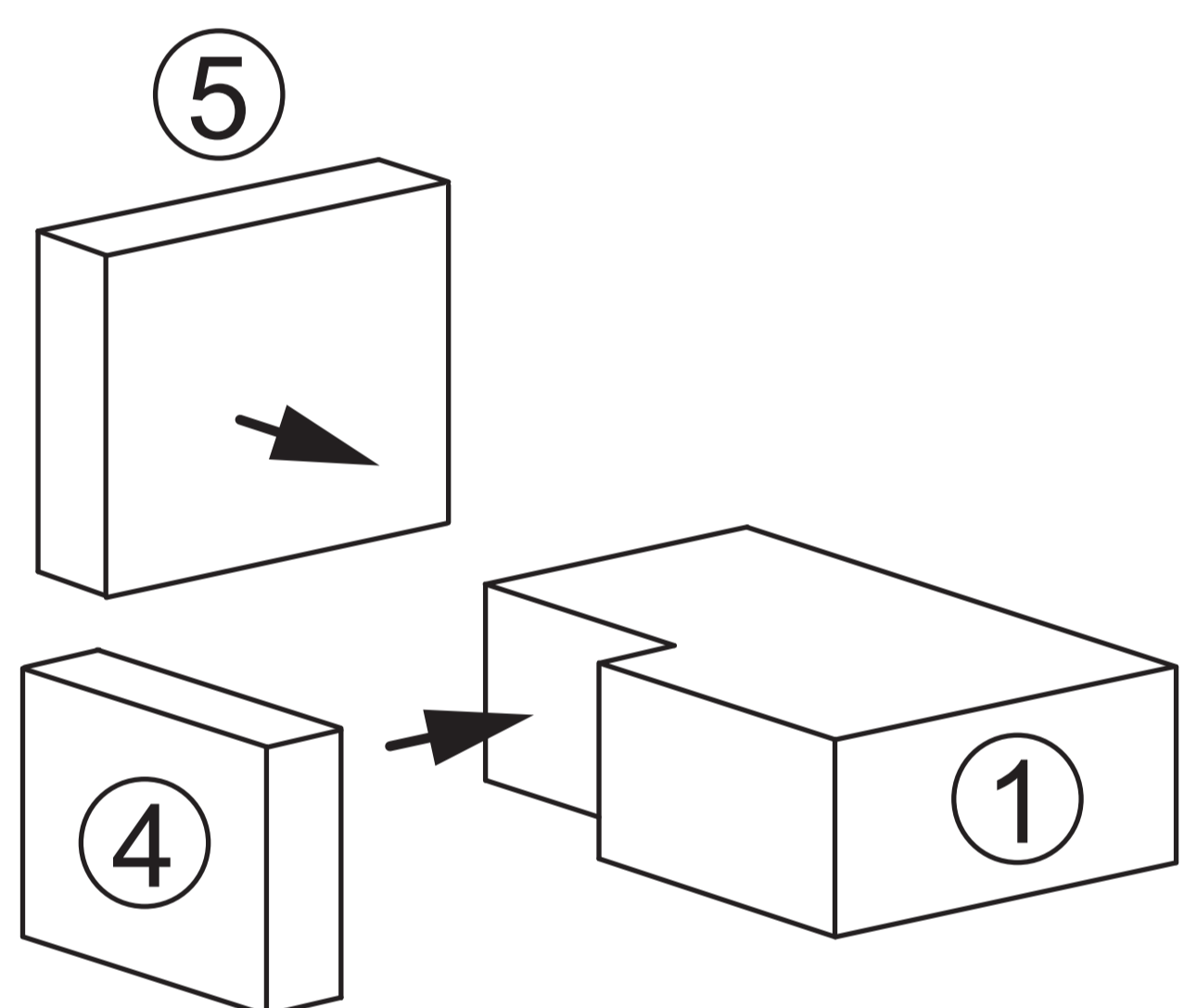
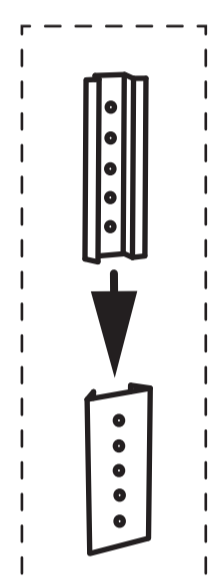
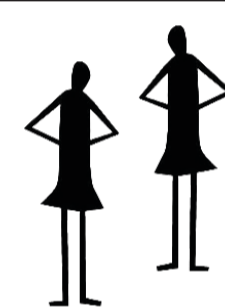

2

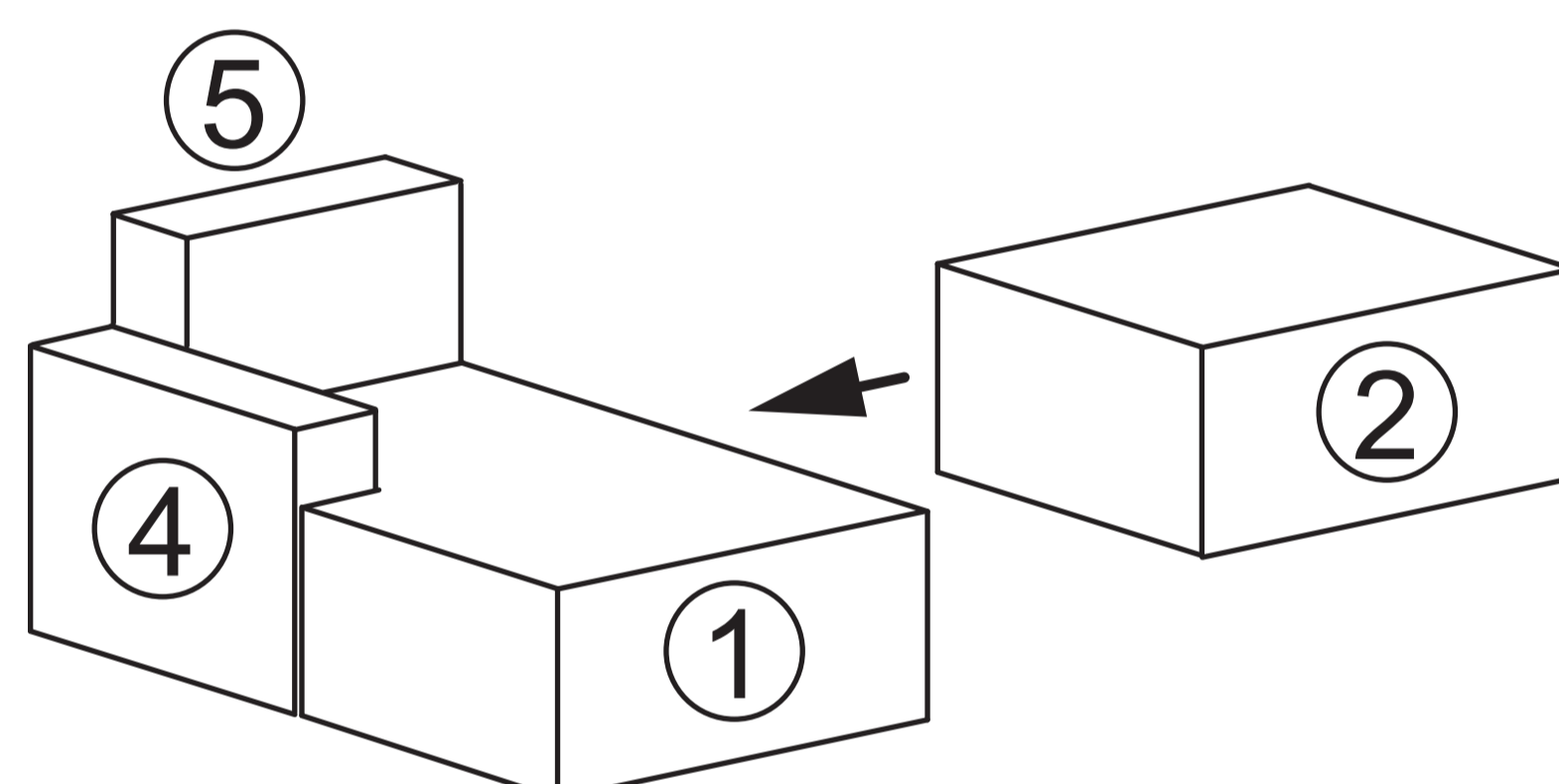
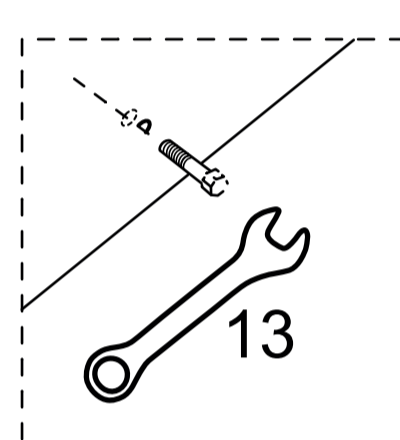
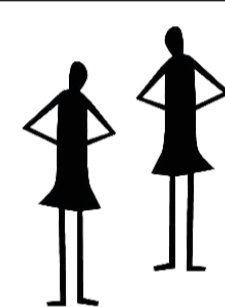

3

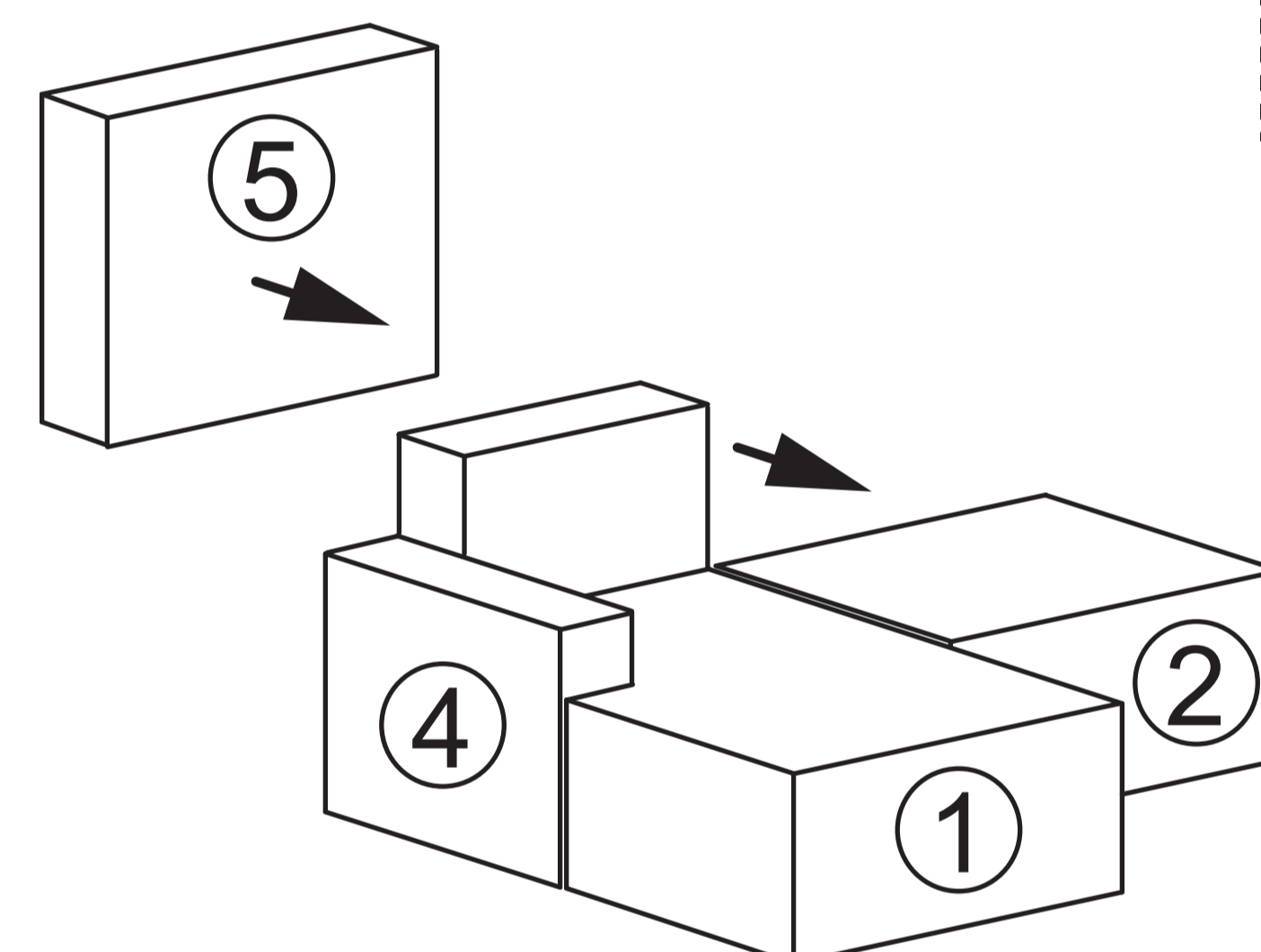
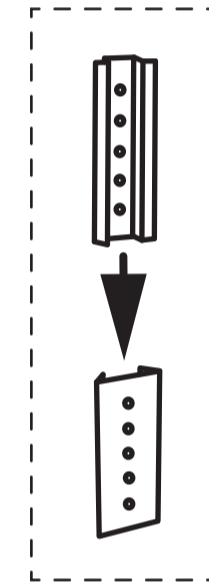
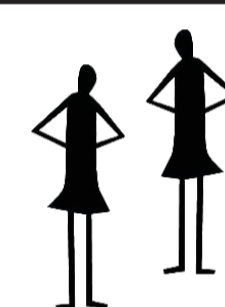

4

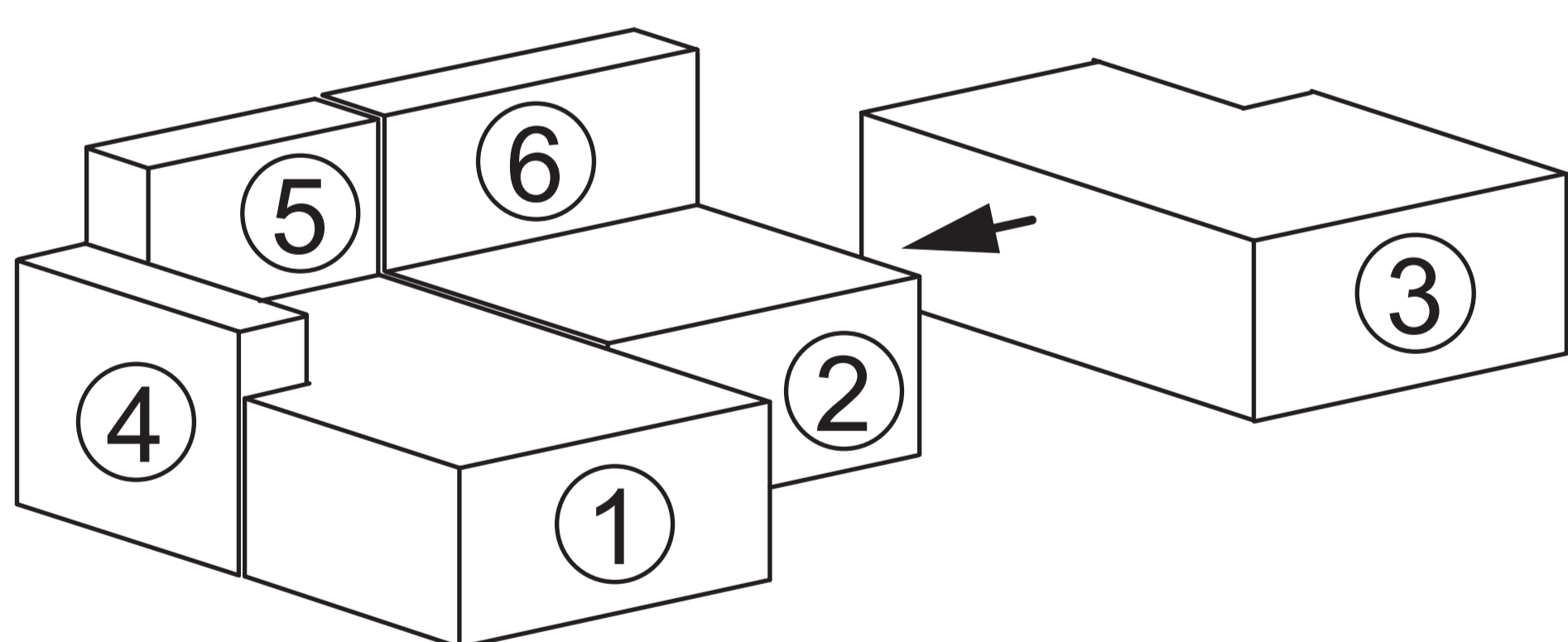
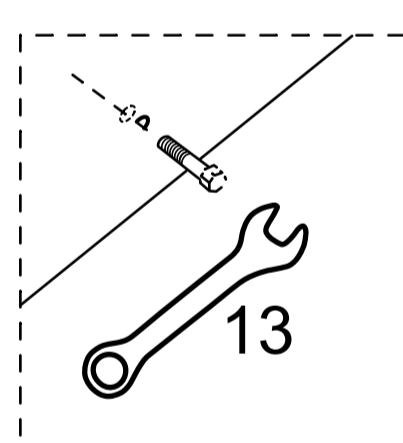
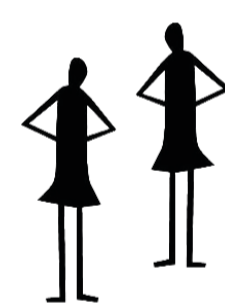

5

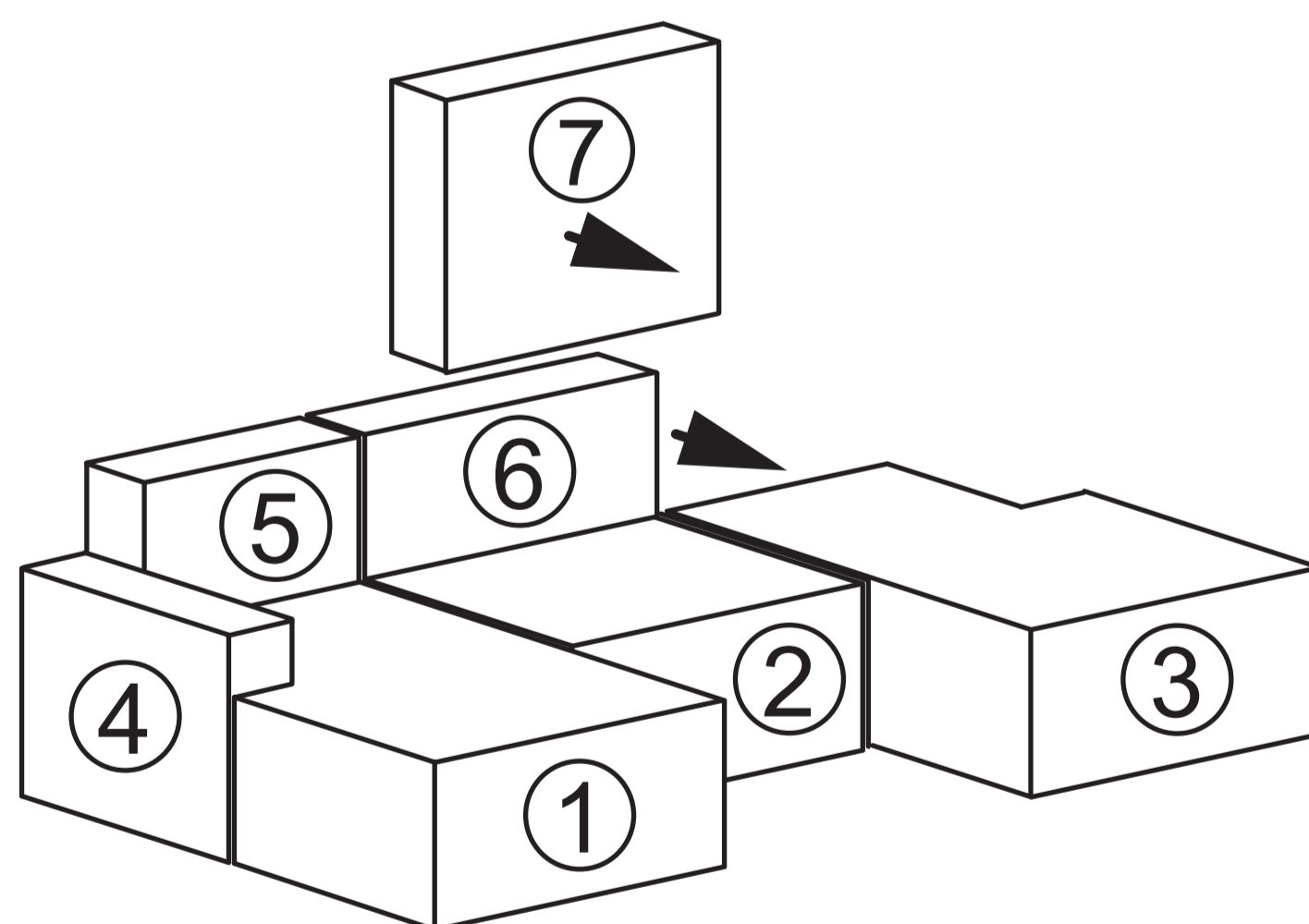
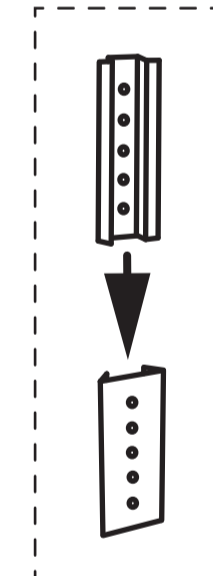
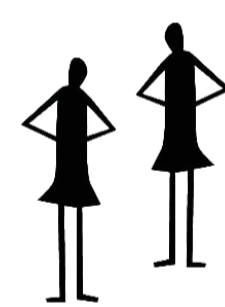

6

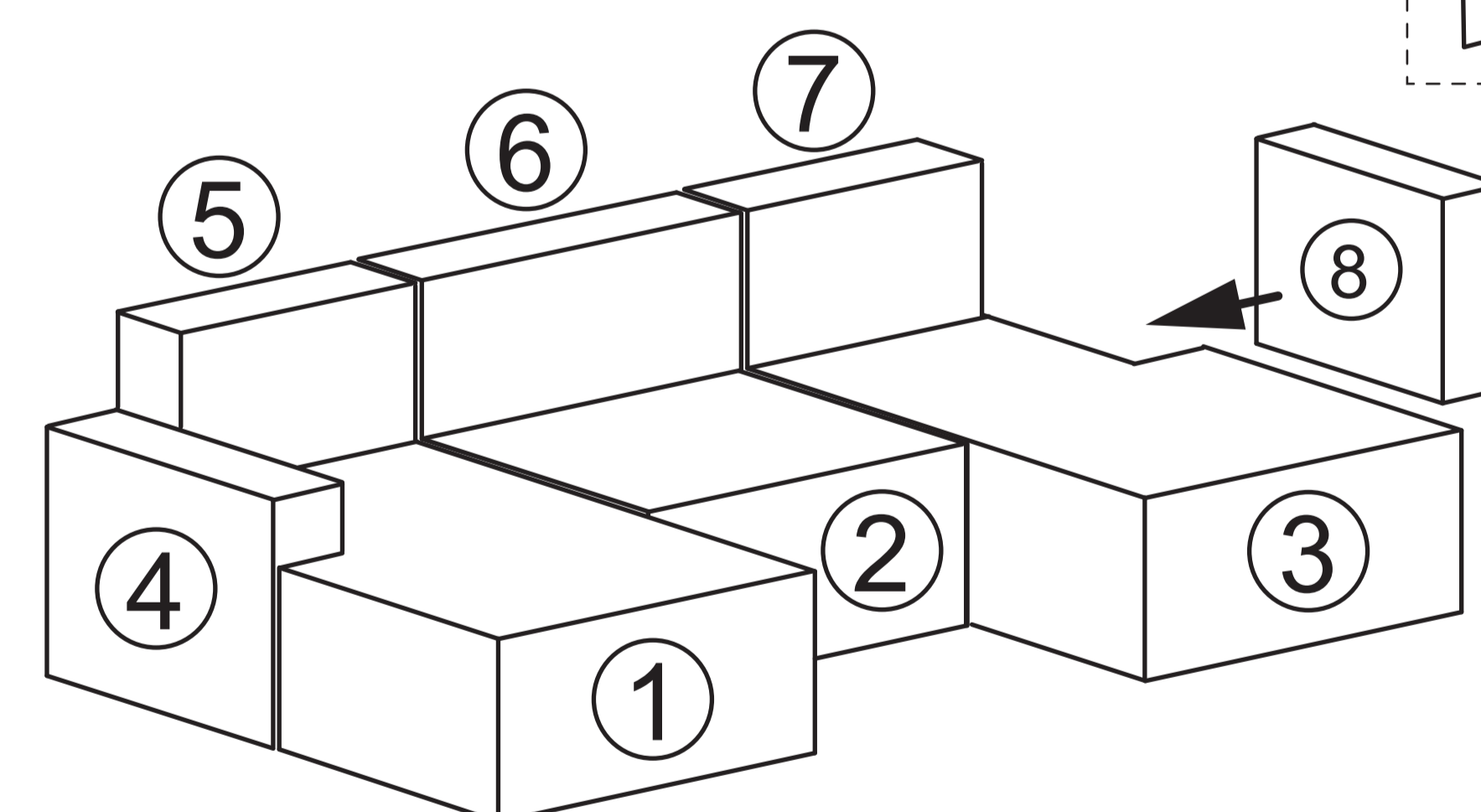
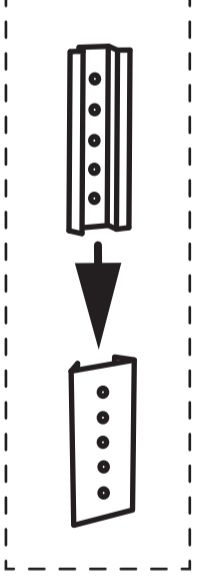

7

