

SOFA - 1, 2, 3

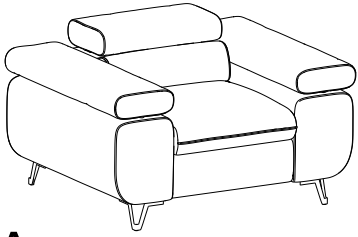

A

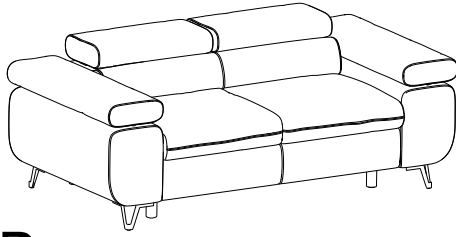

B

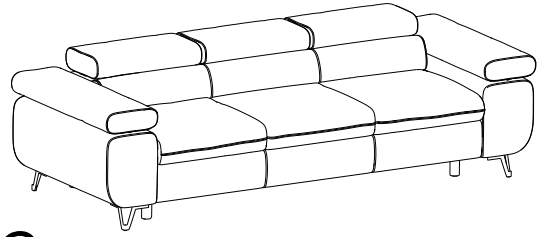

C

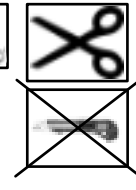
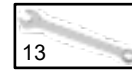
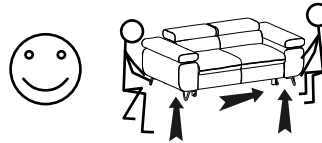
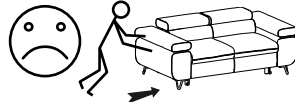
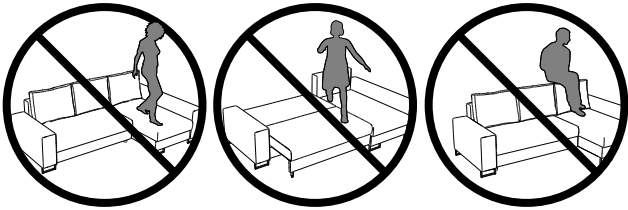

#	QUANTITY MENGE ILOSC
1	1
2	1
3	1
4	2

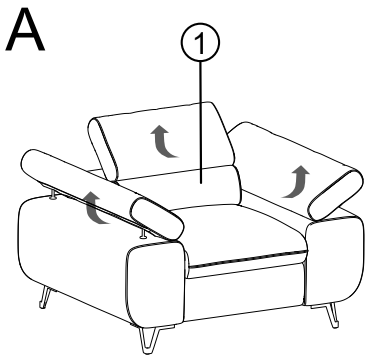

A

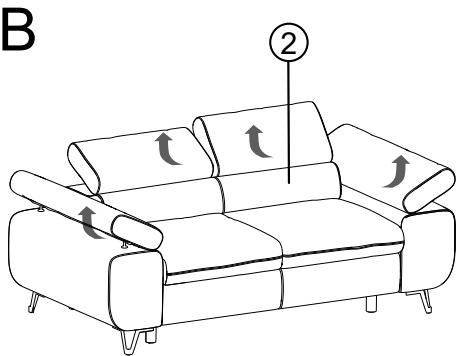

B

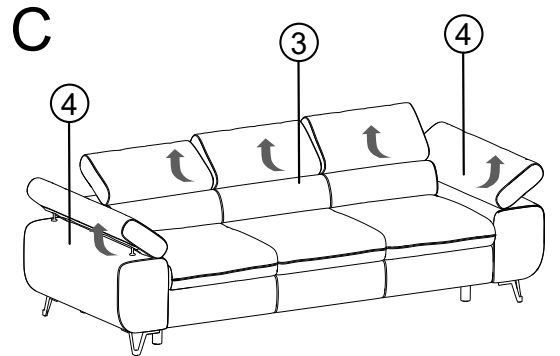

C

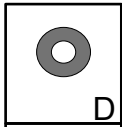

D

8

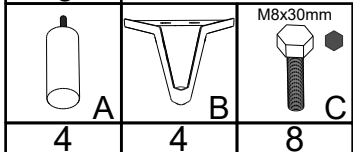

4

4

8

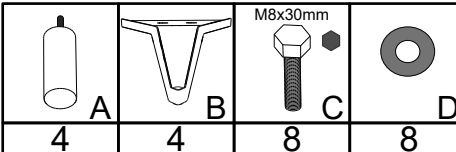

4

4

8

8

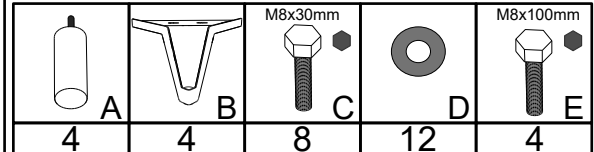

4

4

8

12

4

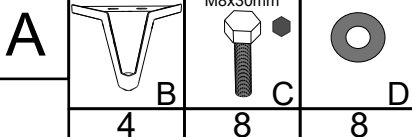

4

8

8



13

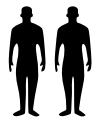
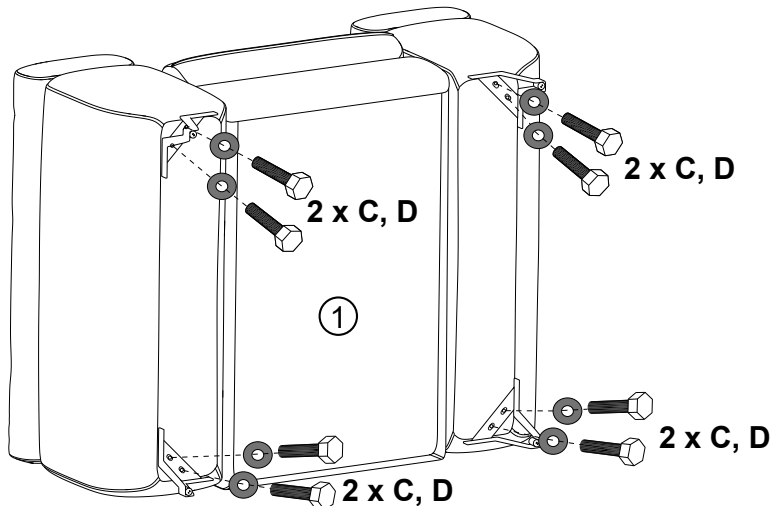

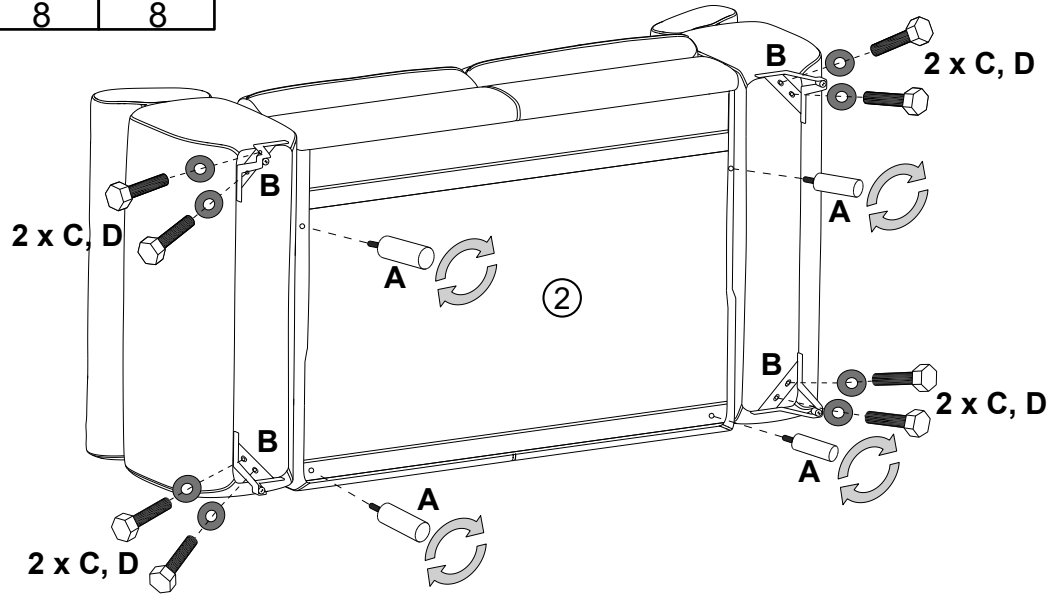
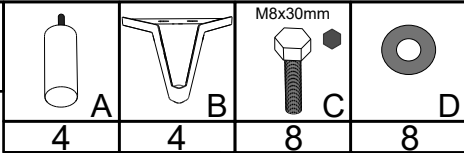
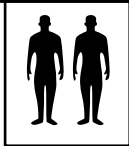
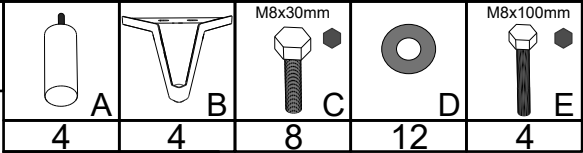
B**C**

STEP-1
SCHRITTE-1
KROK-1

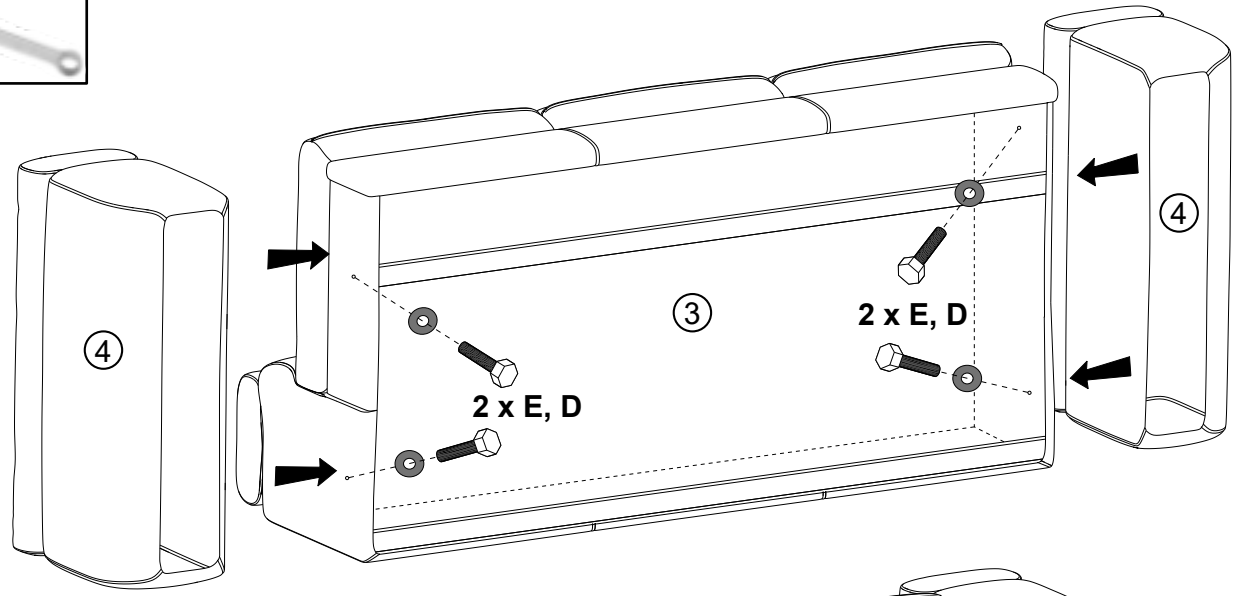

STEP-2
SCHRITTE-2
KROK-2

