

# Installation sanleitung Installation Instruction Instruction d'installation

SKU:N879P429014

SKU:N879P429015

SKU:N879P429016

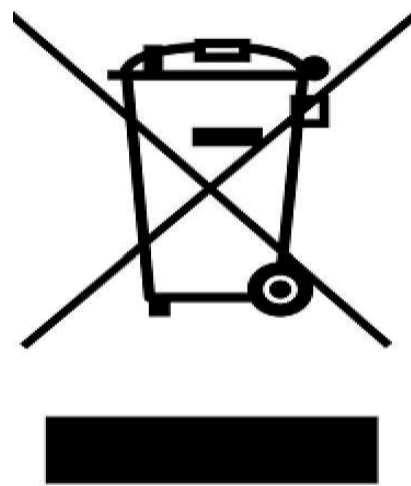
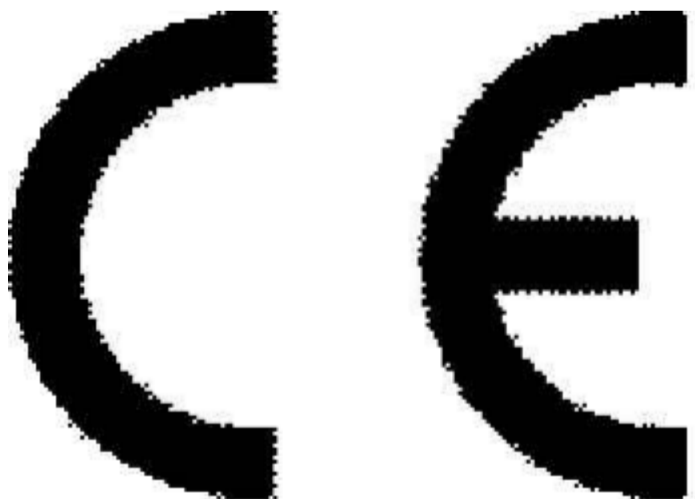
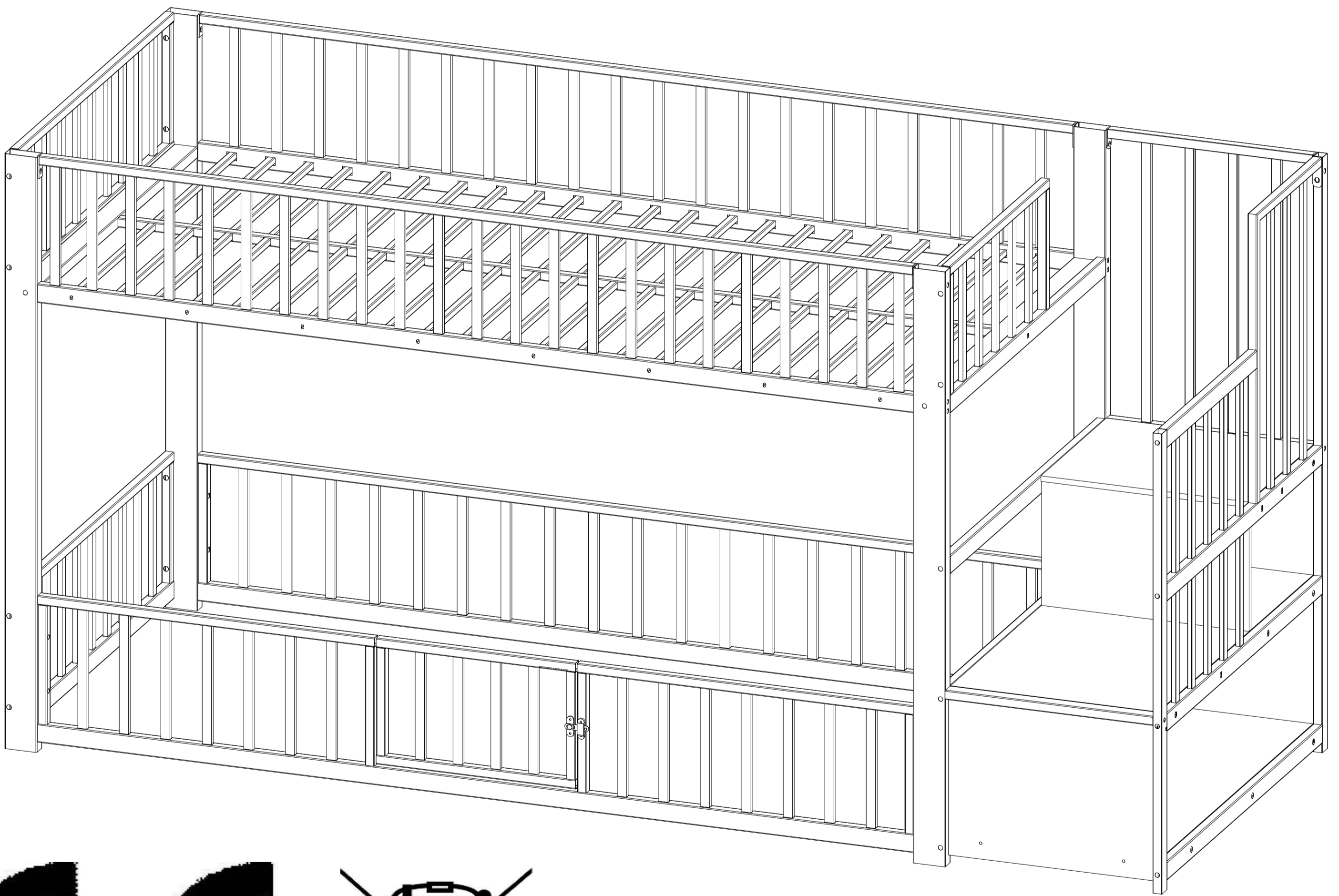

Points de collecte sur [www.quefairedemesdechets.fr](http://www.quefairedemesdechets.fr)  
Privilégiez la réparation ou le don de votre appareil !

**Unser Produkt wird Ihnen in 3 Paketen geliefert. Die Lieferzeiten dieser 3 Pakete können abweichen, bitte haben Sie etwas Geduld und vielen Dank für Ihr Verständnis.**

**Our product will be delivered to you in 3 packages. The delivery times of these 3 packages may differ, please be patient and thank you for your understanding.**

**Notre produit vous sera livré en 3 colis. Les délais de livraison de ces 3colis peuvent différer,**

# **IMPORTANT- READ CAREFULLY-**

## **RETAIN FOR FUTURE REFERENCE**

### **TOP TIPS BEFORE YOU START !**

1. Please check that all parts & hardware are present before you start the assembly of your furniture.
2. For ease and speed of assembly, we recommend that before you commence each step of the assembly,  
  
Please identify all the parts required for that step.
3. We recommend that where possible, all items are assembled near to the area in which they will be placed in use,  
  
to avoid moving the product unnecessarily once assembled.
4. For the protection of your furniture, particularly items of high gloss finish, we recommend that the product is placed on a  
  
Protected surface during assembly to prevent any damage.
5. During assembly please take care not to over-tighten any fittings, as this may damage the product.

### **CARE AND MAINTENANCE OF YOUR FURNITURE**

1. Please periodically check all fittings and re-tighten as necessary.
2. To clean your item, please use a damp cloth and wipe clean.
3. Never allow any kind of liquid to remain on your furniture. Absorption can cause wood to warp or finishes to de-laminate
4. Please do not place hot items (e.g hot drinks) directly on the wood surface.
5. Please do not drag or pull your furniture.

### **IMPORTANT INFORMATION**

1. The recommended size of mattress: (W) 90cm x (L) 200cm x (H) 10cm.
2. Maximum thickness of mattress: 12cm.
3. Children should be discouraged from playing on top of this bunk bed.
4. The bunk bed should be checked periodically by the owner to ensure that the guardrail, ladder, and other components are maintained in the correct position and state of repair and that all connectors are tight.
5. A bunk bed is not to be placed near a ceiling fan unless the distance between the closest points on the ceiling fan bunk. Bed is at least 2 metres.
6. Use guardrails on both sides of upper bunk.

7. Children should play sensibly in and around the bed to avoid falling and injury.
8. The bed is designed for one person on each level only.
9. Use Ladder for entering and leaving upper bunk.
10. If the bunk bed will be placed next to the wall, the guardrail that runs the full length of the bed should be placed against The wall to prevent entrapment between the bed and the wall.
11. WARNING Do not use the bunk bed/high bed if any structural part is broken or missing.
12. Ventilation of the room is necessary in order to keep the humidity low and to prevent mould in and around the bed.
13. WARNING "high beds & the upper bed of bunk beds are not suitable for children under six years due to risk of injury from falls".
14. WARNING "children can become trapped between the bed & the wall, a roof pitch, the ceiling, adjoining pieces of furniture (e.g. cupboards) and the like. To avoid risk of serious injury the distance between the top safety barrier and the adjoining structure shall not exceed 75mm nor shall be more than 230mm".
15. WARNING: Always ensure the platform and the stairs are permanently attached to this bunk bed before use.
16. A statement to check regularly that all assembly fastenings are properly tightened;
17. This child bed conforms to EN 747-1 : 2024 & EN 747-2 : 2024 "Furniture - Bunk beds and high beds".
18. Always follow the manufacturer's instructions.

**STRANGULATION HAZARD:**

19. Never attach or hang items to any part of the bunk bed that are not designed for use with the bed for example, but not limited to hooks, belts and jump ropes.
20. WARNING "Bunk Beds and high beds can present a serious risk of injury from strangulation if not used correctly. Never attach or hang items to any part of the bunk bed that are not designed to be used with the bed. for example, but not limited to ropes, strings, cords, hooks, belts and bags".

## **WICHTIG - SORGFÄLTIG LESEN -**

## **FÜR SPÄTERE VERWENDUNG AUFBEWAHREN**

### **TOP-TIPPS, BEVOR SIE STARTEN!**

1. Bitte überprüfen Sie, ob alle Teile und Beschläge vorhanden sind, bevor Sie mit der Montage Ihrer Möbel beginnen.
2. Für eine einfache und schnelle Montage empfehlen wir, dass Sie vor jedem Montageschritt Bitte identifizieren Sie alle für diesen Schritt erforderlichen Teile
3. Wir empfehlen, alle Artikel möglichst in der Nähe des Einsatzortes zu montieren um ein unnötiges Bewegen des Produkts nach der Montage zu vermeiden.
4. Zum Schutz Ihrer Möbel, insbesondere von Möbeln mit Hochglanzoberfläche, empfehlen wir, das Produkt auf einen Geschützte Oberfläche während der Montage um eventuelle Beschädigungen zu vermeiden.
5. Achten Sie bei der Montage darauf, die Verschraubungen nicht zu fest anzuziehen, da dies zu einer Beschädigung des Produkts führen kann.

### **PFLEGE UND WARTUNG IHRER MÖBEL**

1. Bitte überprüfen Sie regelmäßig alle Verschraubungen und ziehen Sie sie bei Bedarf nach.
2. Verwenden Sie zum Reinigen Ihres Artikels bitte ein feuchtes Tuch und wischen Sie ihn sauber.
3. Lassen Sie niemals Flüssigkeiten auf Ihren Möbeln zurück. Durch die Aufnahme kann sich das Holz verziehen oder die Oberfläche kann sich ablösen.
4. Bitte stellen Sie keine heißen Gegenstände ( z. B. heiße Getränke) direkt auf die Holzoberfläche.
5. Bitte schleifen oder ziehen Sie Ihre Möbel nicht.

### **NICHTIGE INFORMATIONEN**

1. Die empfohlene Matratzengröße: (B) 90 cm x (L) 200 cm x (H) 10 cm.
2. Maximale Matratzendicke: 12cm.
3. Kinder sollten davon abgehalten werden, auf diesem Etagenbett zu spielen.
4. Das Etagenbett sollte regelmäßig vom Eigentümer überprüft werden, um sicherzustellen, dass Geländer, Leiter und andere Komponenten in der richtigen Position und im richtigen Zustand gehalten werden und dass alle Verbindungselemente fest sind.
5. Ein Etagenbett darf nicht in der Nähe eines Deckenventilators aufgestellt werden, es sei denn, der Abstand zwischen den nächstgelegenen Punkten des Etagenbetts mit Deckenventilator beträgt mindestens 2 Meter.

6. Verwenden Sie an beiden Seiten der oberen Koje Schutzgeländer.
7. Kinder sollten vernünftig im und um das Bett spielen, um Stürze und Verletzungen zu vermeiden.
8. Das Bett ist auf jeder Ebene nur für eine Person ausgelegt.
9. Benutzen Sie die Leiter zum Ein- und Aussteigen aus dem oberen Bett.
10. Wenn das Etagenbett neben der Wand aufgestellt wird, sollte das über die gesamte Länge des Bettes verlaufende Schutzgeländer gegen Die Wand verhindert ein Einklemmen zwischen Bett und Wand.
11. **WARNUNG** Verwenden Sie das Etagenbett/Hochbett nicht, wenn ein Bauteil gebrochen ist oder fehlt.
12. Eine Belüftung des Zimmers ist notwendig, um die Luftfeuchtigkeit niedrig zu halten und Schimmelbildung im und um das Bett vorzubeugen.
13. **WARNUNG** „Hochbetten & das Oberbett von Etagenbetten sind wegen Verletzungsgefahr durch Stürze nicht für Kinder unter sechs Jahren geeignet.“
14. **WARNUNG:** „Kinder können zwischen Bett und Wand, einer Dachschräge, der Decke, angrenzenden Möbelstücken (z. B. Schränken) und dergleichen eingeklemmt werden. Um die Gefahr schwerer Verletzungen zu vermeiden, darf der Abstand zwischen der oberen Sicherheitsbarriere und der angrenzenden Struktur 75 mm nicht überschreiten und nicht mehr als 230 mm betragen.“
15. **WARNUNG:** Stellen Sie immer sicher, dass die Plattform und die Treppe vor dem Gebrauch dauerhaft an diesem Etagenbett befestigt sind.
16. Eine Anweisung, regelmäßig zu überprüfen, ob alle Montagebefestigungen richtig angezogen sind;
17. Dieses Kinderbett entspricht EN 747- 1 : 2024 & EN 747-2 : 2024 "Möbel - Etagenbetten und Hochbetten".
18. Befolgen Sie immer die Anweisungen des Herstellers.

**STRANGULATIONSGEFAHR:**

19. Befestigen oder hängen Sie niemals Gegenstände an Teilen des Etagenbetts auf, die nicht für die Verwendung mit dem Bett vorgesehen sind (z. B. Haken, Gürtel und Springseile).
20. **WARNUNG** „Bei unsachgemäßer Verwendung von Etagenbetten und Hochbetten besteht die Gefahr einer Strangulation. Befestigen oder hängen Sie niemals Gegenstände an Teilen des Etagenbetts auf, die nicht für die Verwendung mit dem Bett vorgesehen sind. Dies sind beispielsweise , jedoch nicht ausschließlich, Seile, Schnüre, Kordeln, Haken, Gürtel und Taschen.“

# **IMPORTANT- À LIRE ATTENTIVEMENT- À CONSERVER POUR RÉFÉRENCE FUTURE**

## **LES BONS CONSEILS AVANT DE COMMENCER !**

1. Veuillez vérifier que toutes les pièces et le matériel sont présents avant de commencer l'assemblage de vos meubles.
2. Pour faciliter et accélérer l'assemblage, nous vous recommandons, avant de commencer chaque étape de l'assemblage,

Veuillez identifier toutes les pièces requises pour cette étape.

3. Nous recommandons que, dans la mesure du possible, tous les articles soient assemblés à proximité de la zone dans laquelle ils seront utilisés,

pour éviter de déplacer inutilement le produit une fois assemblé.

4. Pour la protection de vos meubles, en particulier des articles à finition brillante, nous vous recommandons de placer le produit sur un

Surface protégée lors du montage pour éviter tout dommage.

5. Lors de l'assemblage, veillez à ne pas trop serrer les raccords, car cela pourrait endommager le produit.

## **SOIN ET ENTRETIEN DE VOS MEUBLES**

1. Veuillez vérifier périodiquement tous les raccords et resserrer si nécessaire.
2. Pour nettoyer votre article, veuillez utiliser un chiffon humide et essuyer.
3. Ne laissez jamais aucun type de liquide rester sur vos meubles. L'absorption peut provoquer la déformation du bois ou le délaminage des finitions.
4. Veuillez ne pas placer d'objets chauds ( par exemple des boissons chaudes) directement sur la surface du bois.
5. Veuillez ne pas traîner ou tirer vos meubles.

## **UNE INFORMATION IMPORTANT**

1. La taille recommandée du matelas : (L) 90 cm x (L) 200 cm x (H) 10 cm.
2. Épaisseur maximale du matelas : 12 cm.
3. Il convient de décourager les enfants de jouer sur ce lit superposé.
4. Le lit superposé doit être vérifié périodiquement par le propriétaire pour s'assurer que le garde-corps, l'échelle et les autres composants sont maintenus dans la bonne position et en bon état et que tous les connecteurs sont bien serrés.

5. Un lit superposé ne doit pas être placé à proximité d'un ventilateur de plafond, à moins que la distance entre les points les plus proches du ventilateur de plafond ne soit respectée. Le lit mesure au moins 2 mètres.
6. Utilisez des garde-corps des deux côtés du lit supérieur.
7. Les enfants doivent jouer raisonnablement dans et autour du lit pour éviter les chutes et les blessures.
8. Le lit est conçu pour une seule personne à chaque niveau.
9. Utilisez l'échelle pour entrer et sortir du lit supérieur.
10. Si le lit superposé doit être placé près du mur, le garde-corps qui s'étend sur toute la longueur du lit doit être placé contre le mur pour éviter tout coincement entre le lit et le mur.
11. AVERTISSEMENT N'utilisez pas le lit superposé/lit surélevé si une pièce structurelle est cassée ou manquante.
12. La ventilation de la pièce est nécessaire afin de maintenir un faible taux d'humidité et d'éviter la moisissure dans et autour du lit.
13. AVERTISSEMENT "les lits hauts et le lit supérieur des lits superposés ne conviennent pas aux enfants de moins de six ans en raison du risque de blessure en cas de chute".
14. AVERTISSEMENT "Les enfants peuvent se retrouver coincés entre le lit et le mur, une pente de toit, le plafond, des meubles attenants (par exemple des placards) et autres. Pour éviter tout risque de blessure grave, la distance entre la barrière de sécurité supérieure et la barrière de sécurité adjacente la structure ne doit pas dépasser 75 mm ni dépasser 230 mm".
15. AVERTISSEMENT: Vérifiez toujours que la plate-forme et l'escalier sont fixés de manière permanente à ce lit superposé avant de l'utiliser.
16. Une déclaration demandant de vérifier régulièrement que toutes les fixations de l'assemblage sont correctement serrées ;
17. Ce lit enfant est conforme aux normes EN 747- 1 : 2024 et EN 747-2 : 2024 "Meubles - Lits superposés et lits hauts".
18. Suivez toujours les instructions du fabricant.

#### **RISQUE D'ÉTRANGULATION :**

19. N'attachez ou ne suspendez jamais d'objets à une partie du lit superposé qui ne sont pas conçus pour être utilisés avec le lit, par exemple, mais sans s'y limiter, des crochets, des ceintures et des cordes à sauter.
20. AVERTISSEMENT "Les lits superposés et les lits hauts peuvent présenter un risque sérieux de blessure par strangulation s'ils ne sont pas utilisés correctement. N'attachez ou ne suspendez jamais d'objets à une partie du lit superposé qui ne sont pas conçus pour être utilisés avec le lit. par exemple, mais sans s'y limiter, les cordes, ficelles, cordons, crochets, ceintures et sacs".

# **IMPORTANTE- LEER CON ATENCIÓN-**

## **CONSERVAR PARA FUTURA REFERENCIA**

### **¡MEJORES CONSEJOS ANTES DE COMENZAR!**

1. Verifique que todas las piezas y herrajes estén presentes antes de comenzar a ensamblar sus muebles.

2. Para facilitar y acelerar el montaje, recomendamos que antes de comenzar cada paso del montaje,

Identifique todas las piezas necesarias para ese paso.

3. Recomendamos que, siempre que sea posible, todos los artículos se monten cerca del área en la que se utilizarán.

para evitar mover el producto innecesariamente una vez montado.

4. Para la protección de sus muebles, especialmente los artículos con acabado de alto brillo, recomendamos colocar el producto sobre una

Superficie protegida durante el montaje para evitar cualquier daño.

5. Durante el montaje, tenga cuidado de no apretar demasiado ningún accesorio, ya que esto podría dañar el producto.

### **CUIDADO Y MANTENIMIENTO DE TUS MUEBLES**

1. Revise periódicamente todos los accesorios y vuelva a apretarlos según sea necesario.

2. Para limpiar su artículo, utilice un paño húmedo y límpielo.

3. Nunca permita que quede ningún tipo de líquido en sus muebles. La absorción puede causar que la madera se deforme o que los acabados se deslaminen.

4. No coloque artículos calientes ( por ejemplo, bebidas calientes) directamente sobre la superficie de madera.

5. No arrastre ni tire de sus muebles.

### **INFORMACIÓN IMPORTANTE**

1. El tamaño recomendado del colchón: (W) 90 cm x (L) 200 cm x (H) 10 cm.

2. Grosor máximo del colchón: 12cm.

3. Se debe disuadir a los niños de jugar encima de esta litera.

4. El propietario debe revisar periódicamente la litera para garantizar que la barandilla, la escalera y otros componentes se mantengan en la posición y estado correctos y que todos los conectores estén apretados.

5. No se debe colocar una litera cerca de un ventilador de techo a menos que la distancia entre los puntos más cercanos de la litera del ventilador de techo. La cama mide al menos 2 metros.
6. Utilice barandillas a ambos lados de la litera superior.
7. Los niños deben jugar con sensatez dentro y alrededor de la cama para evitar caídas y lesiones.
8. La cama está diseñada para una persona en cada nivel únicamente.
9. Utilice la escalera para entrar y salir de la litera superior.
10. Si la litera se va a colocar junto a la pared, la barandilla que recorre toda la longitud de la cama debe colocarse contra la pared para evitar atrapamientos entre la cama y la pared.
11. ADVERTENCIA No utilice la litera/cama alta si alguna pieza estructural está rota o falta.
12. La ventilación de la habitación es necesaria para mantener baja la humedad y evitar moho dentro y alrededor de la cama.
13. ADVERTENCIA "Las camas altas y la cama superior de las literas no son adecuadas para niños menores de seis años debido al riesgo de lesiones por caídas".
14. ADVERTENCIA "Los niños pueden quedar atrapados entre la cama y la pared, la pendiente del tejado, el techo, los muebles contiguos (por ejemplo, armarios) y similares. Para evitar el riesgo de lesiones graves, la distancia entre la barrera de seguridad superior y la barrera de seguridad contigua La estructura no excederá los 75 mm ni excederá los 230 mm".
15. ADVERTENCIA: Asegúrese siempre de que la plataforma y la escalera están fijadas permanentemente a esta litera antes de su uso.
16. Una declaración para comprobar regularmente que todas las fijaciones de montaje están bien apretadas;
17. Esta cama infantil cumple con EN 747-1 : 2024 y EN 747-2: 2024. "Mobiliario - Literas y camas altas".
18. Siga siempre las instrucciones del fabricante.

**PELIGRO DE ESTRANGULACIÓN:**

19. Nunca coloque ni cuelgue elementos en ninguna parte de la litera que no estén diseñados para usarse con la cama, por ejemplo, entre otros, ganchos, cinturones y cuerdas para saltar.
20. ADVERTENCIA "Las literas y las camas altas pueden presentar un riesgo grave de lesiones por estrangulamiento si no se usan correctamente. Nunca fije ni cuelgue elementos en ninguna parte de la litera que no estén diseñados para usarse con la cama, por ejemplo, pero no limitado a cuerdas, cordeles, cordones, ganchos, cinturones y bolsas".

## **IMPORTANTE - LEGGERE ATTENTAMENTE -**

### **CONSERVARE PER RIFERIMENTO FUTURO**

#### **I MIGLIORI CONSIGLI PRIMA DI INIZIARE!**

1. Verificare che tutte le parti e l'hardware siano presenti prima di iniziare l'assemblaggio dei mobili.
2. Per facilitare e velocizzare l'assemblaggio, si consiglia prima di iniziare ogni fase dell'assemblaggio, identificare tutte le parti necessarie per questo passaggio.
3. Raccomandiamo, ove possibile, che tutti gli articoli siano assemblati vicino all'area in cui verranno utilizzati,  
per evitare di spostare inutilmente il prodotto una volta assemblato
4. Per la protezione dei tuoi mobili, in particolare degli articoli con finitura lucida, ti consigliamo di posizionare il prodotto su una  
superficie protetta durante il montaggio per evitare eventuali danni.
5. Durante il montaggio fare attenzione a non stringere eccessivamente i raccordi, poiché ciò potrebbe danneggiare il prodotto.

#### **CURA E MANUTENZIONE DEI VOSTRI MOBILI**

1. Controllare periodicamente tutti i raccordi e serrarli nuovamente se necessario.
2. Per pulire l'articolo, utilizzare un panno umido e pulirlo.
3. Non lasciare mai alcun tipo di liquido sui mobili. L'assorbimento può causare la deformazione del legno o la delaminazione delle finiture.
4. Si prega di non posizionare oggetti caldi (ad esempio bevande calde) direttamente sulla superficie del legno.
5. Si prega di non trascinare o tirare i mobili.

#### **INFORMAZIONI IMPORTANTI**

1. Dimensioni consigliate del materasso: (L) 90 cm x (L) 200 cm x (A) 10 cm.
2. Spessore massimo del materasso: 12 cm.
3. I bambini dovrebbero essere scoraggiati dal giocare sul letto a castello.
4. Il letto a castello deve essere controllato periodicamente dal proprietario per garantire che il parapetto, la scala e gli altri componenti siano mantenuti nella posizione corretta e in stato di riparazione e che tutti i connettori siano serrati.
5. Un letto a castello non deve essere posizionato vicino a un ventilatore da soffitto, a meno che non sia rispettata la distanza tra i punti più vicini sul letto a castello. Il letto è di almeno 2 metri.

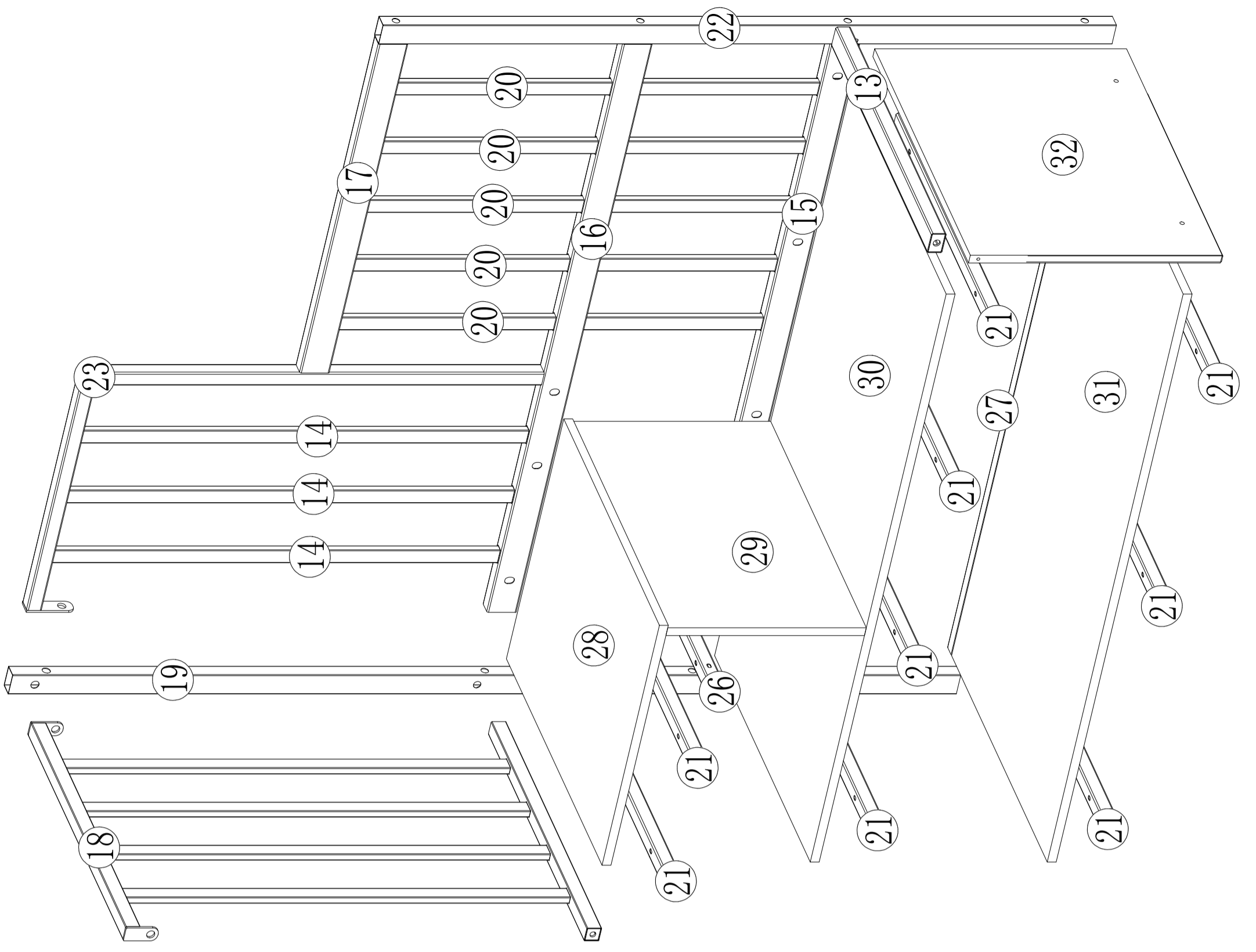
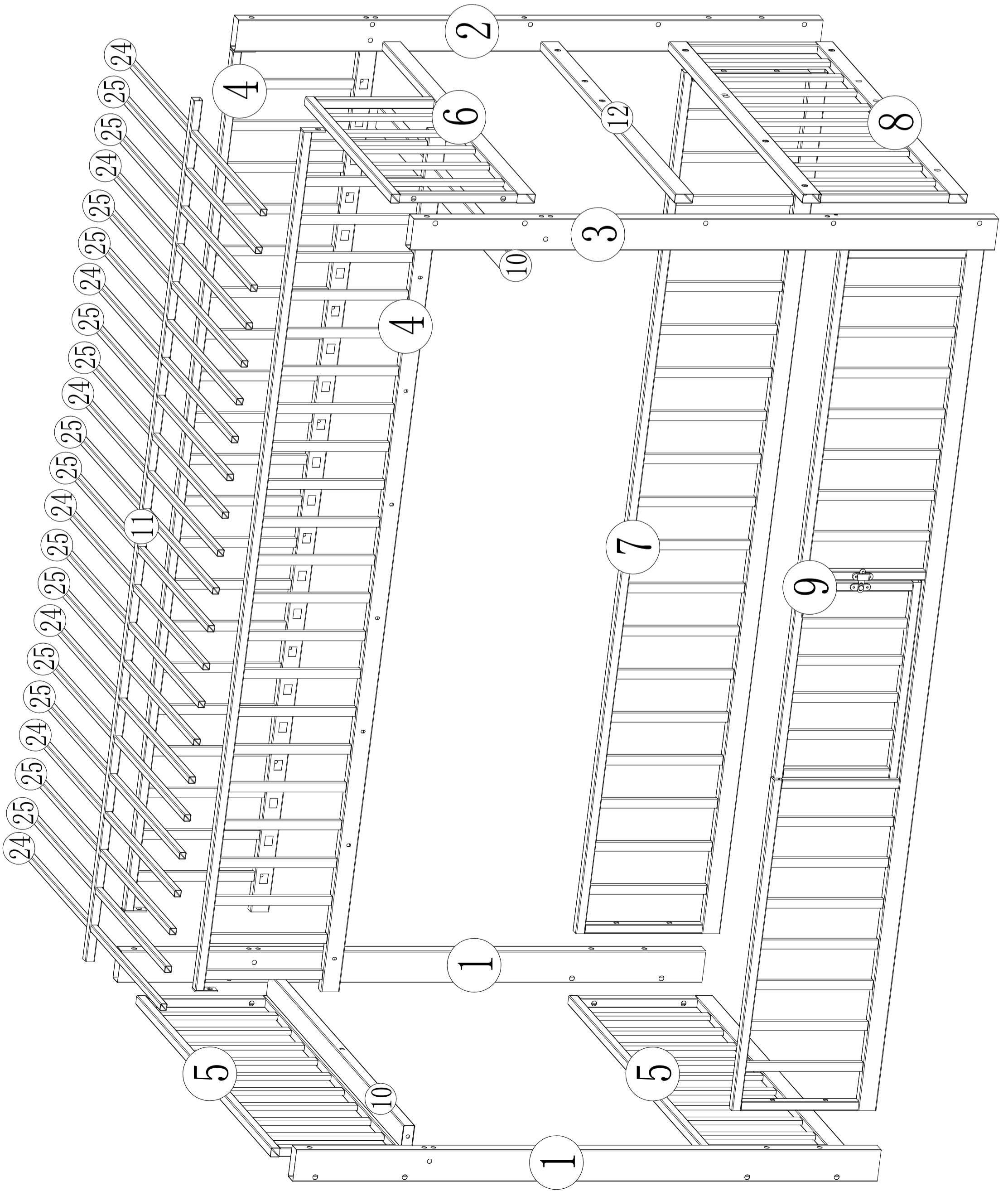

# Hardware List

# N879P429014

①

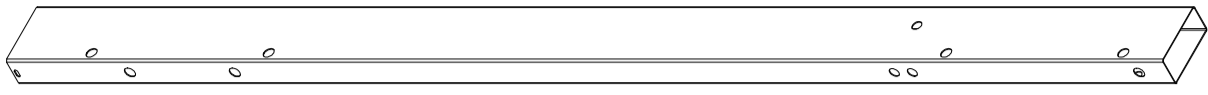

2pc

②

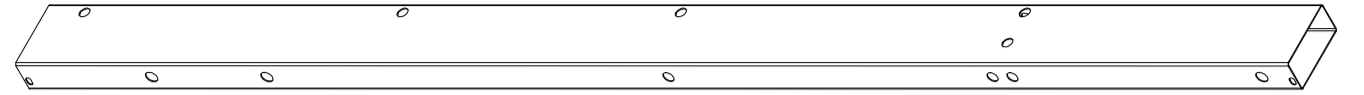

1pc

③

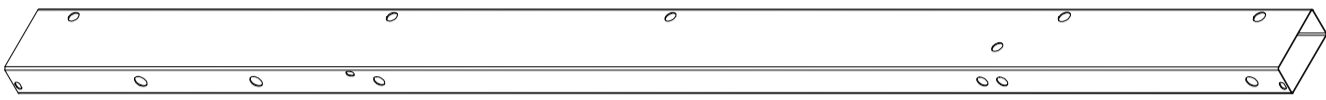

1pc

④

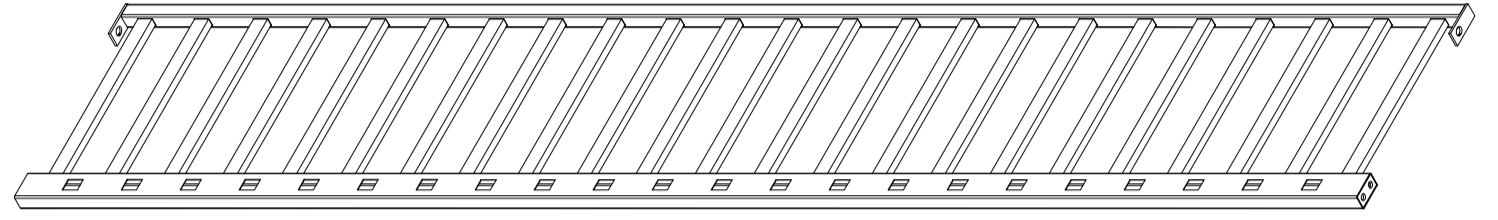

2pc

⑦

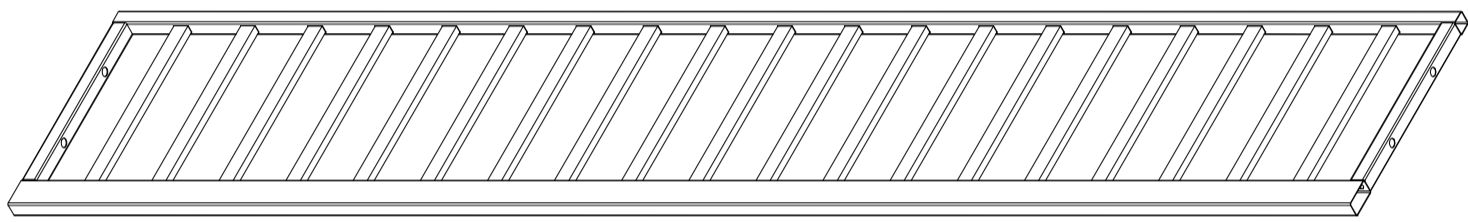

1pc

⑨

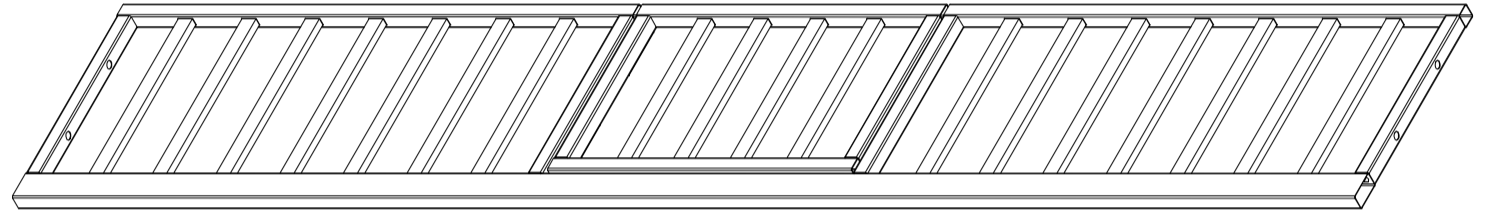

1pc

⑪



1pc

⑲

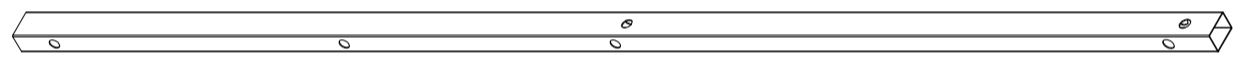

1pc









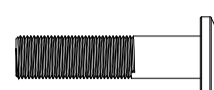

⑥⑩

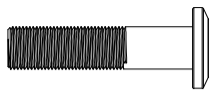
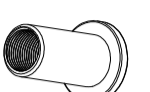
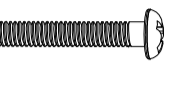
3pc



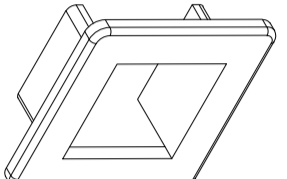
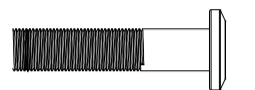

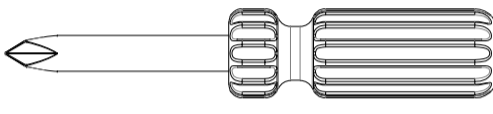

⑥⑪

1pc

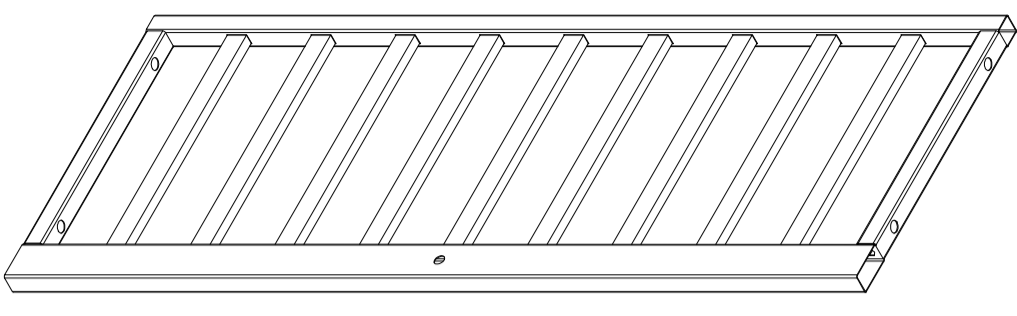
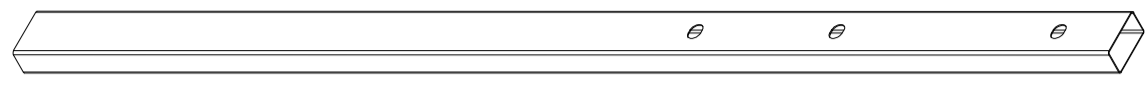
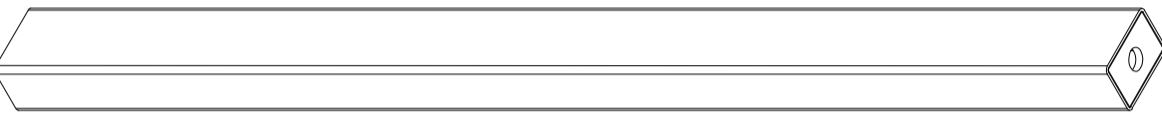
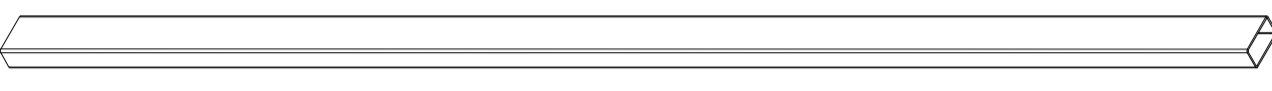
# Hardware List N879P429014

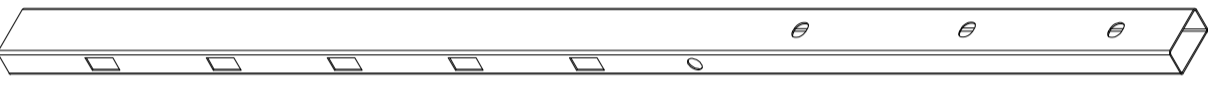
<p>(B)  M8*15mm 1pcs</p>	<p>(C)  M8*35mm 25pcs</p>	<p>(D)  M8*55mm 1pcs</p>	<p>(E)  M6*25mm 16pcs</p>
<p>(F)  M8*15mm 22pcs</p>	<p>(G)  M4*25mm 24pcs</p>	<p>(R)  M4*35mm 1pcs</p>	<p>(P)  M8*85mm 18pcs</p>
<p>(X)  M8*45mm 28pcs</p>	<p>(T)  M8*65mm 4pcs</p>	<p>(K)  44pcs</p>	<p>(U)  M8*25mm 1pcs</p>
<p>(I)  M4*85mm 1pcs</p>	<p>(Q) </p>	<p>(M) </p>	<p>(L) </p>
<p>(L) </p>			

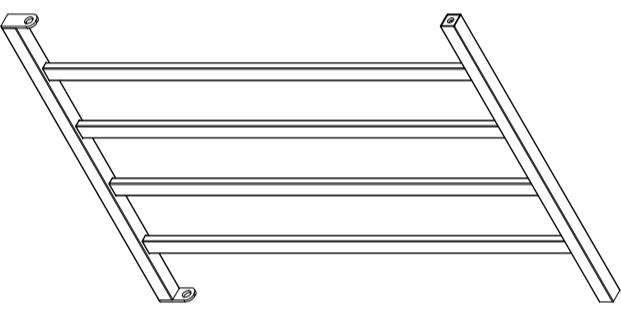
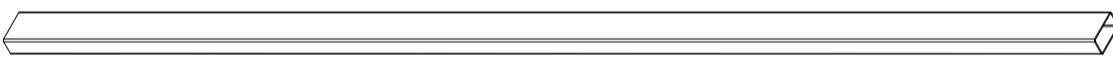
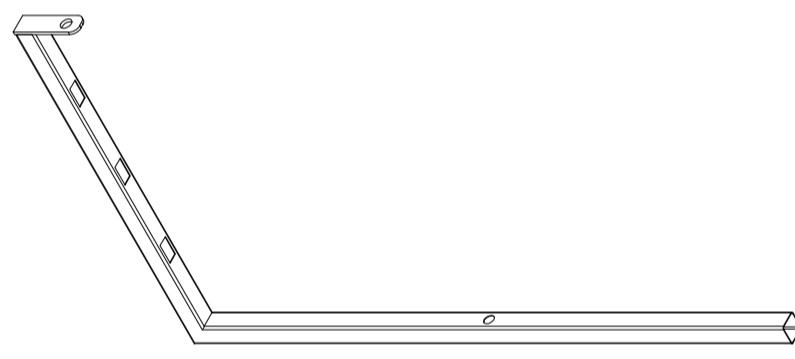
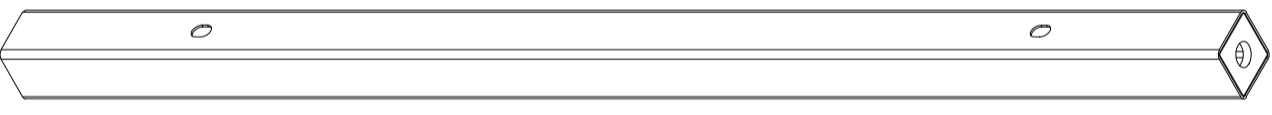
# Hardware List N879P429015

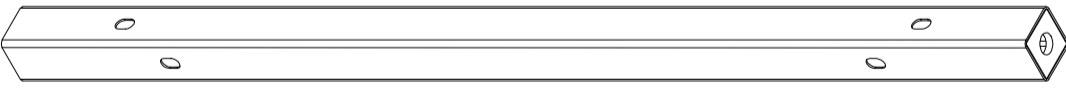
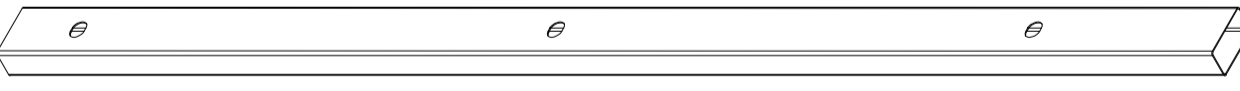
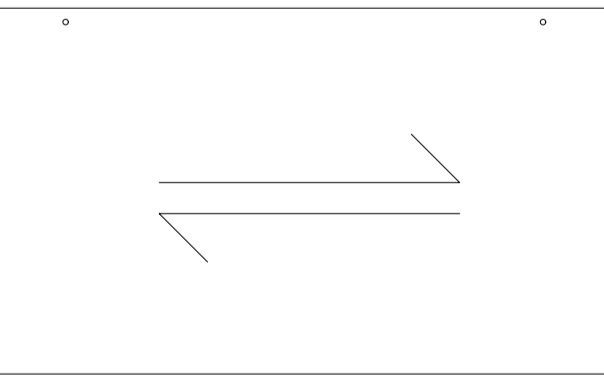
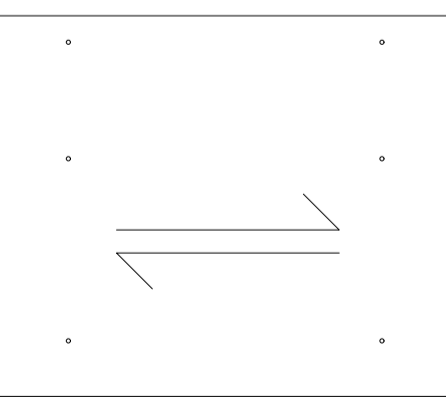
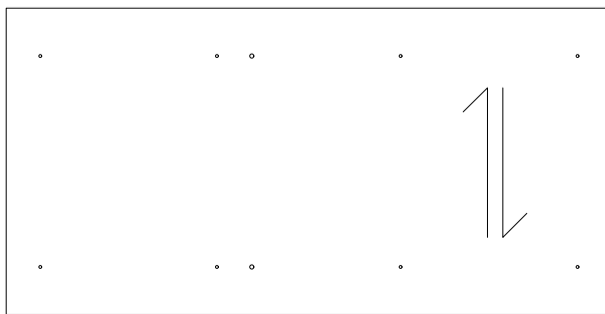
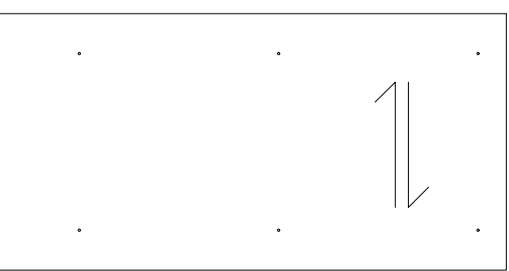
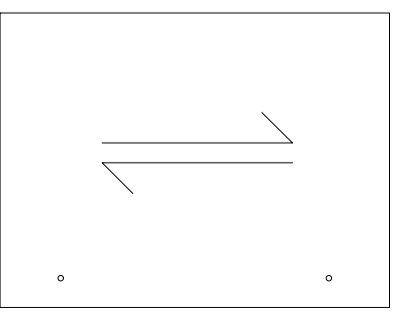
<p>5</p>  <p>1pc</p>	<p>12</p>  <p>1pc</p>
<p>13</p>  <p>1pc</p>	<p>14</p>  <p>3pc</p>
<p>15</p>  <p>1pc</p>	<p>16</p>  <p>1pc</p>
<p>17</p>  <p>1pc</p>	<p>18</p>  <p>1pc</p>
<p>20</p>  <p>4pc</p>	<p>23</p>  <p>1pc</p>
<p>21</p>  <p>9pc</p>	<p>25</p>  <p>12pc</p>
<p>26</p>  <p>1pc</p>	<p>27</p>  <p>1pc</p>
<p>29</p>  <p>1pc</p>	<p>28</p>  <p>1pc</p>
<p>30</p>  <p>1pc</p>	<p>31</p>  <p>1pc</p>
<p>32</p>  <p>1pc</p>	

# Hardware List N879P429016

5

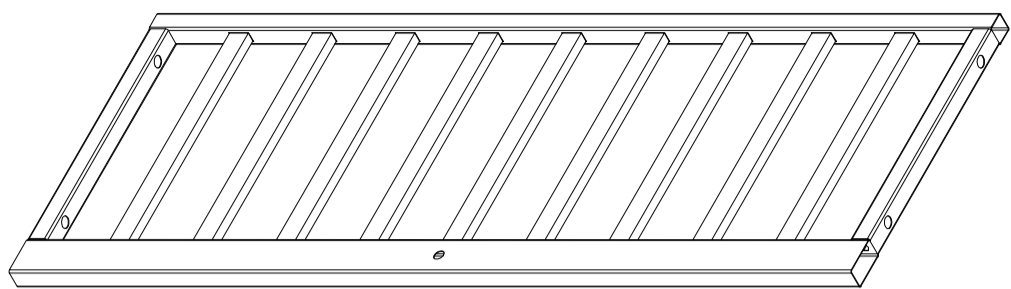

1pc

6

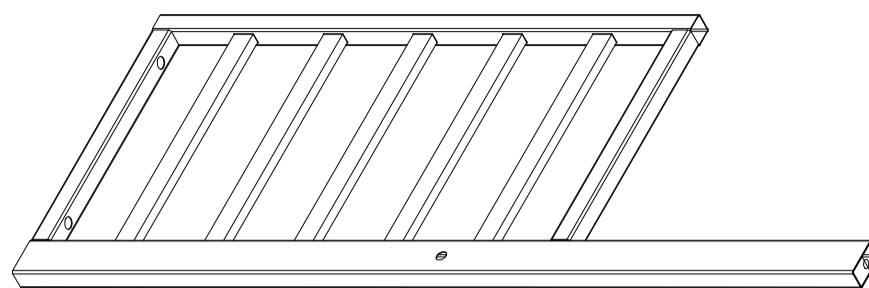

1pc

8

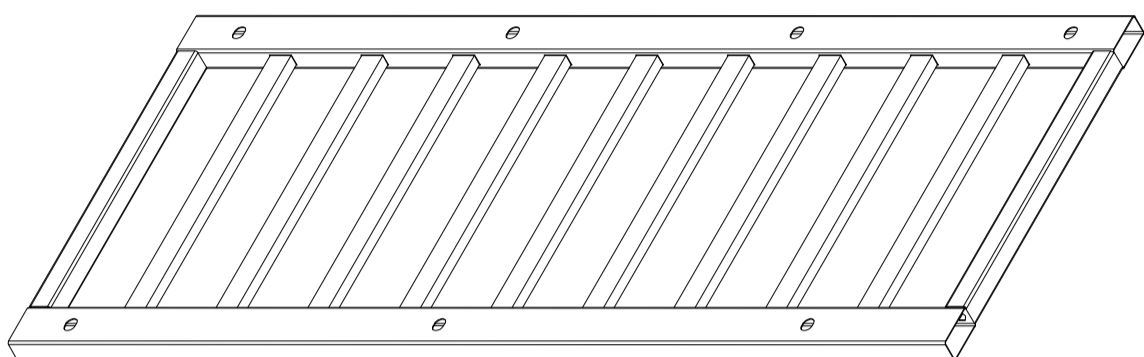

1pc

10

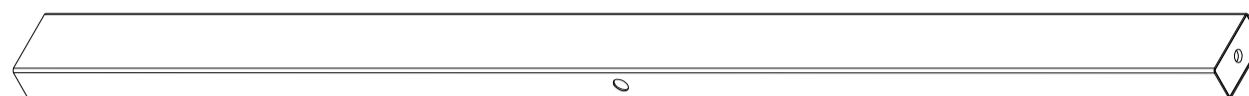

2pc

20



1pc

22



1pc

24

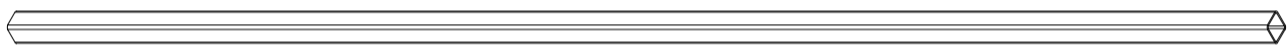

8pc

25

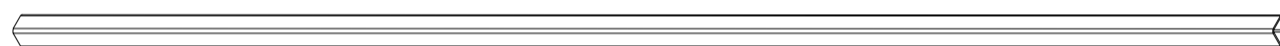

2pc

1

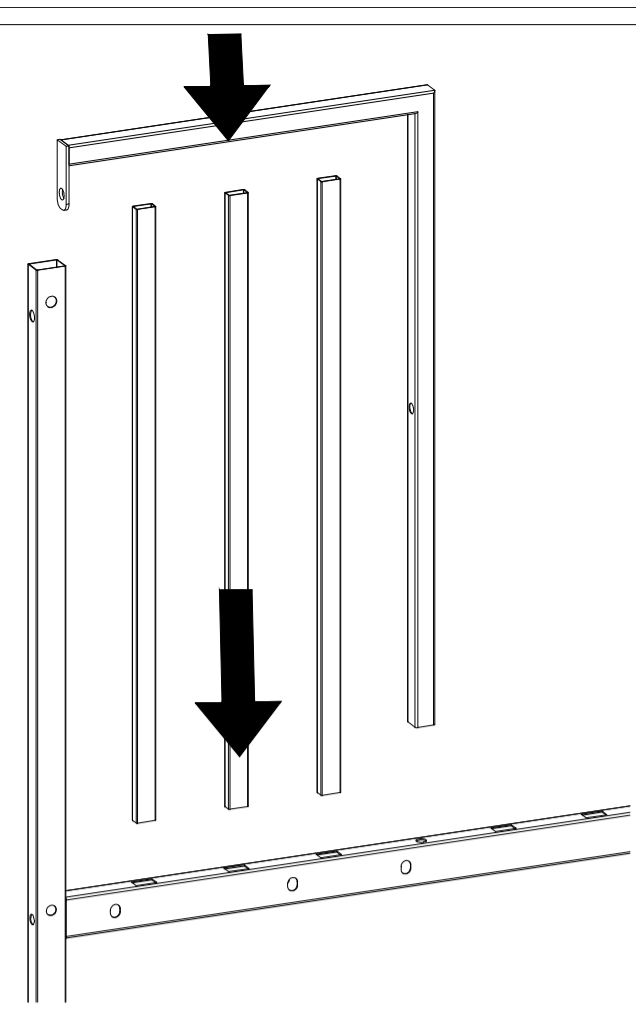
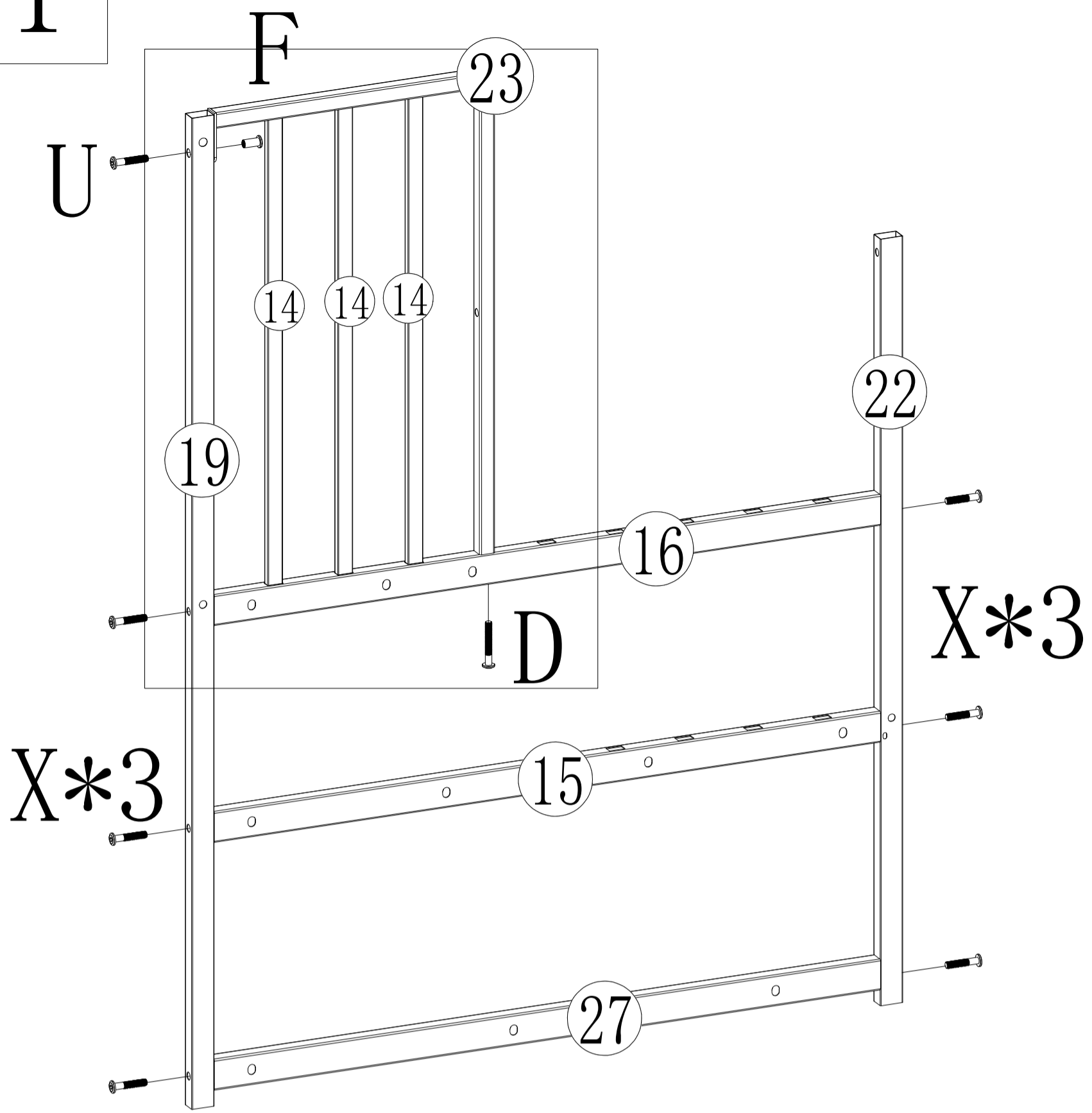

L



M8\*55mm

D × 1PCS

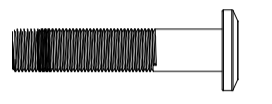

M8\*45mm

X × 6PCS

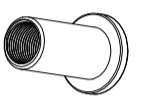

M8\*20mm

F × 1PCS

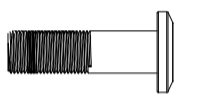

M8\*25mm

U × 1PCS

2

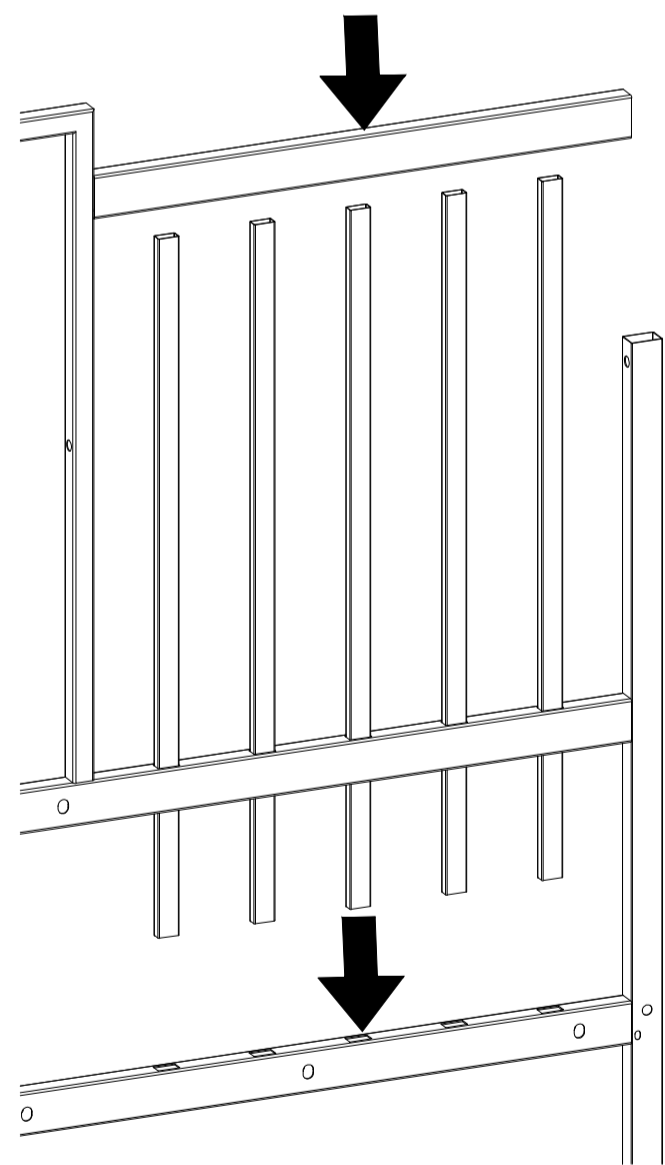
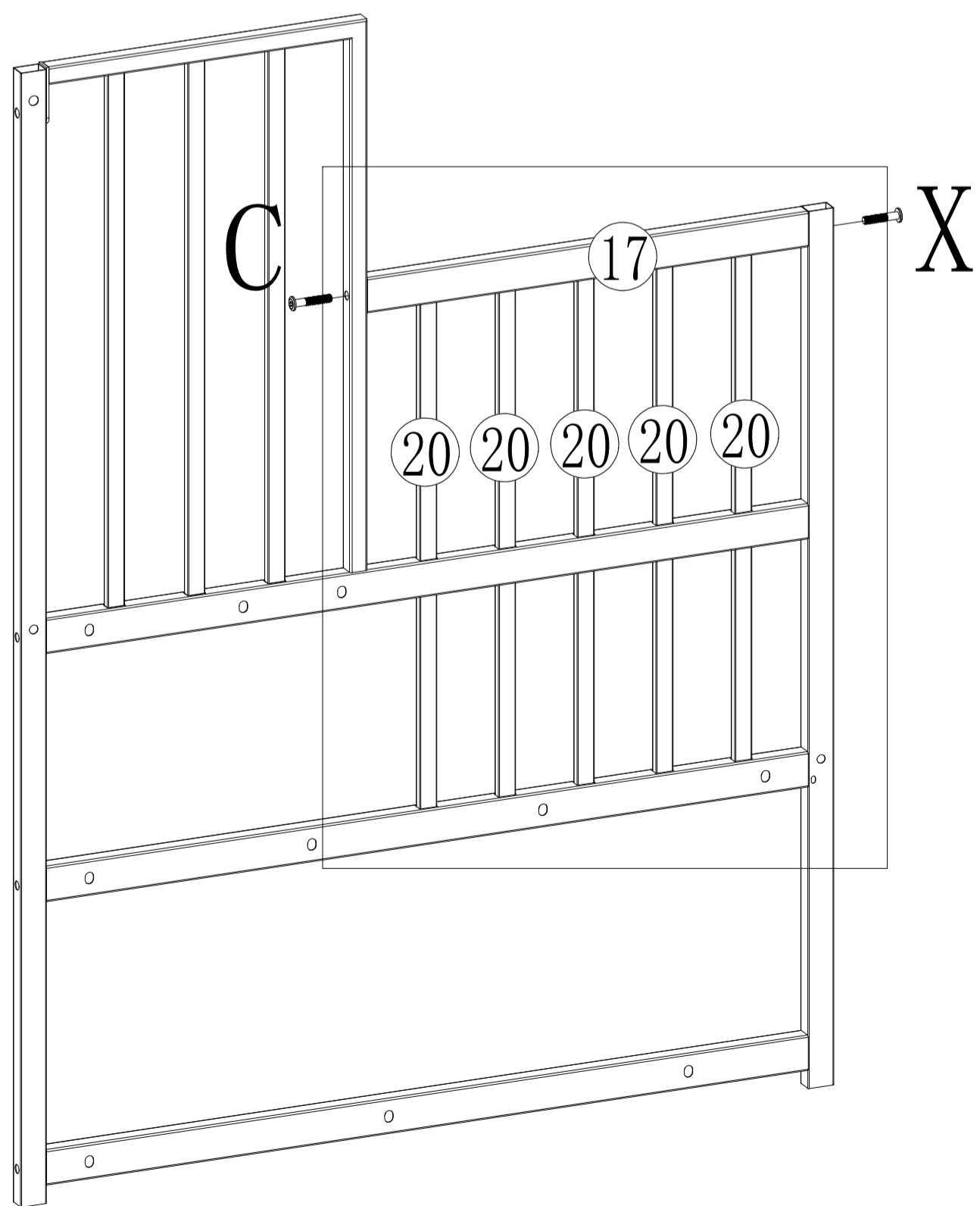

L

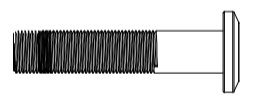

M8\*45mm

X × 1PCS

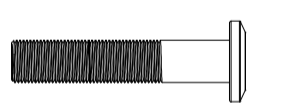

M8\*35mm

C × 1PCS

3

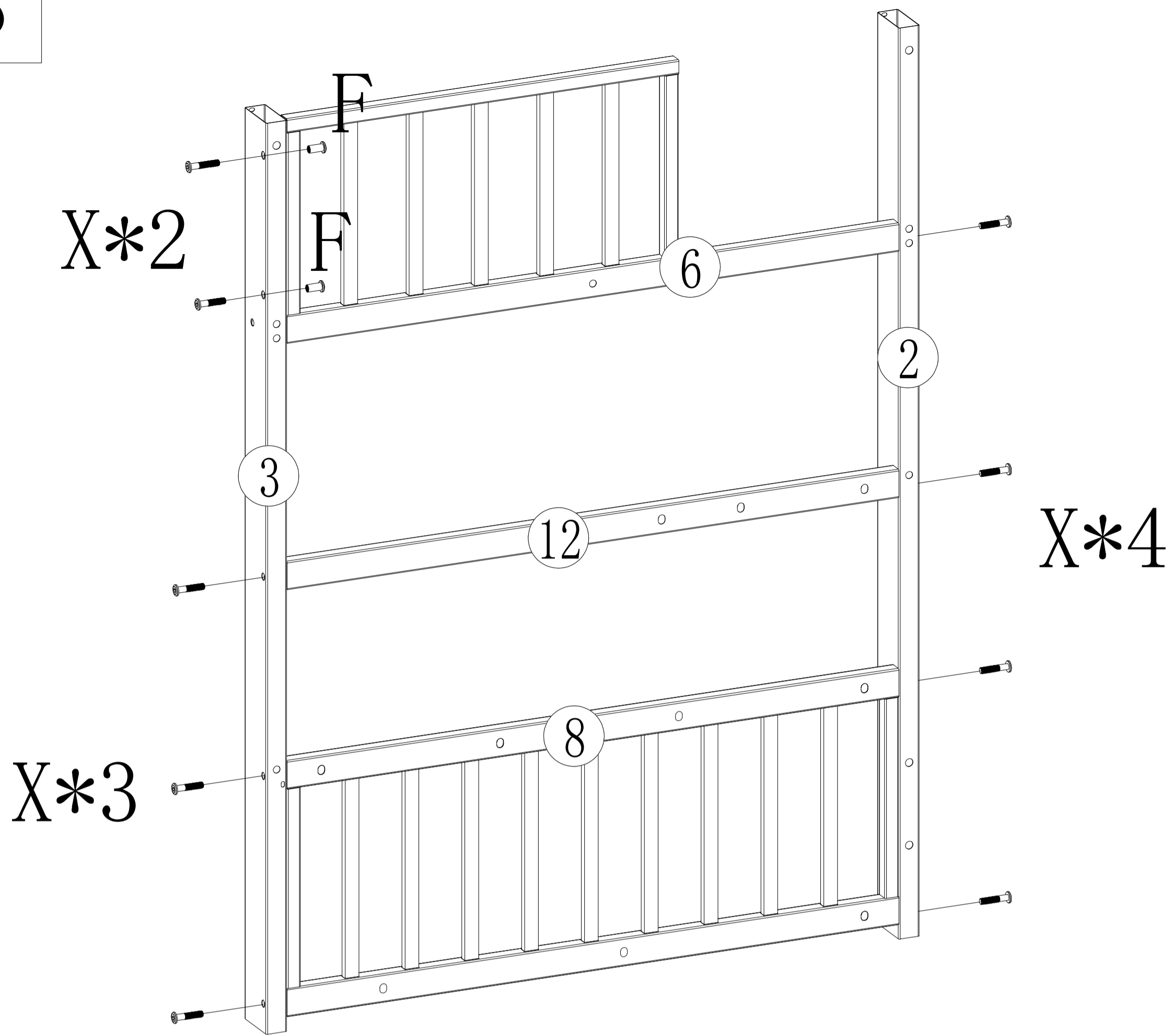

L

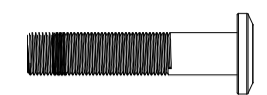

M8\*45mm

X × 9PCS

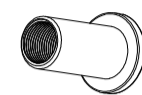

M8\*20mm

F × 2PCS

4

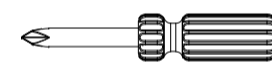
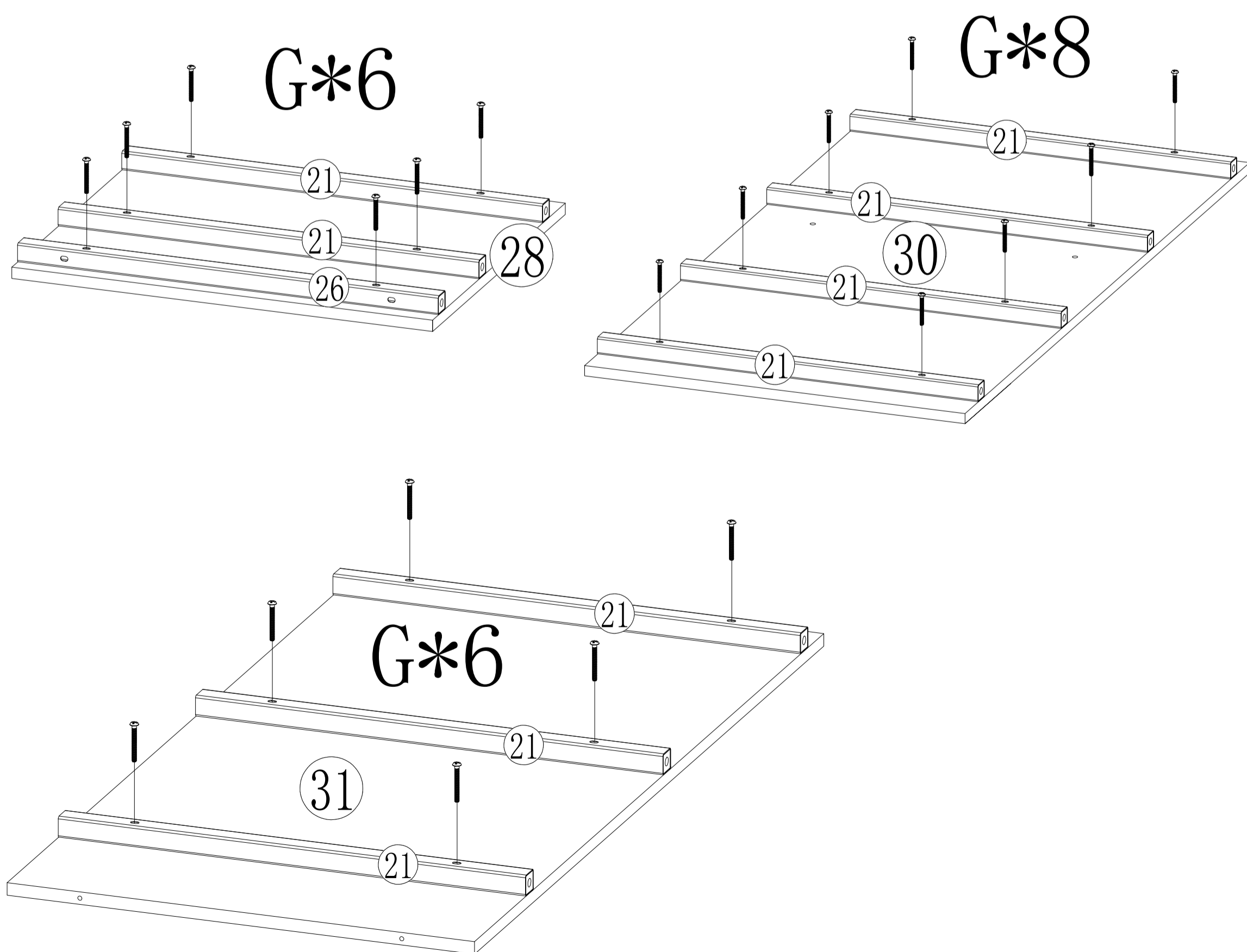

M



M4\*25mm

G × 20PCS

5

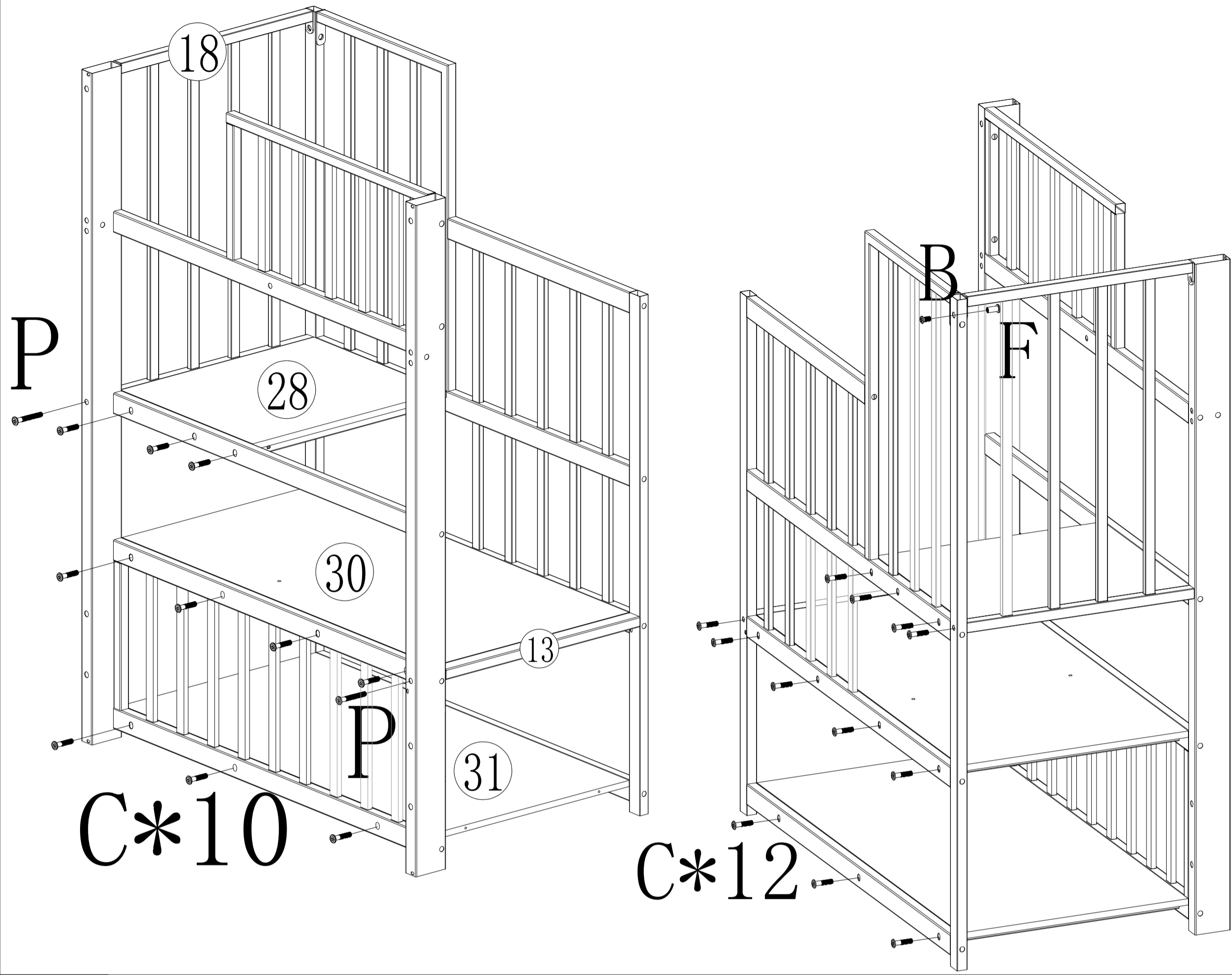

L

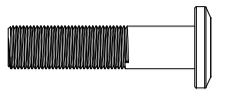

M8\*15mm

B × 1PCS

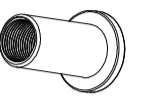

M8\*20mm

F × 1PCS

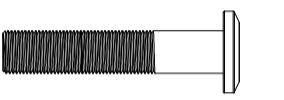

M8\*35mm

C × 22PCS



M8\*85mm

P × 2PCS

6

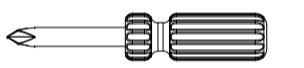
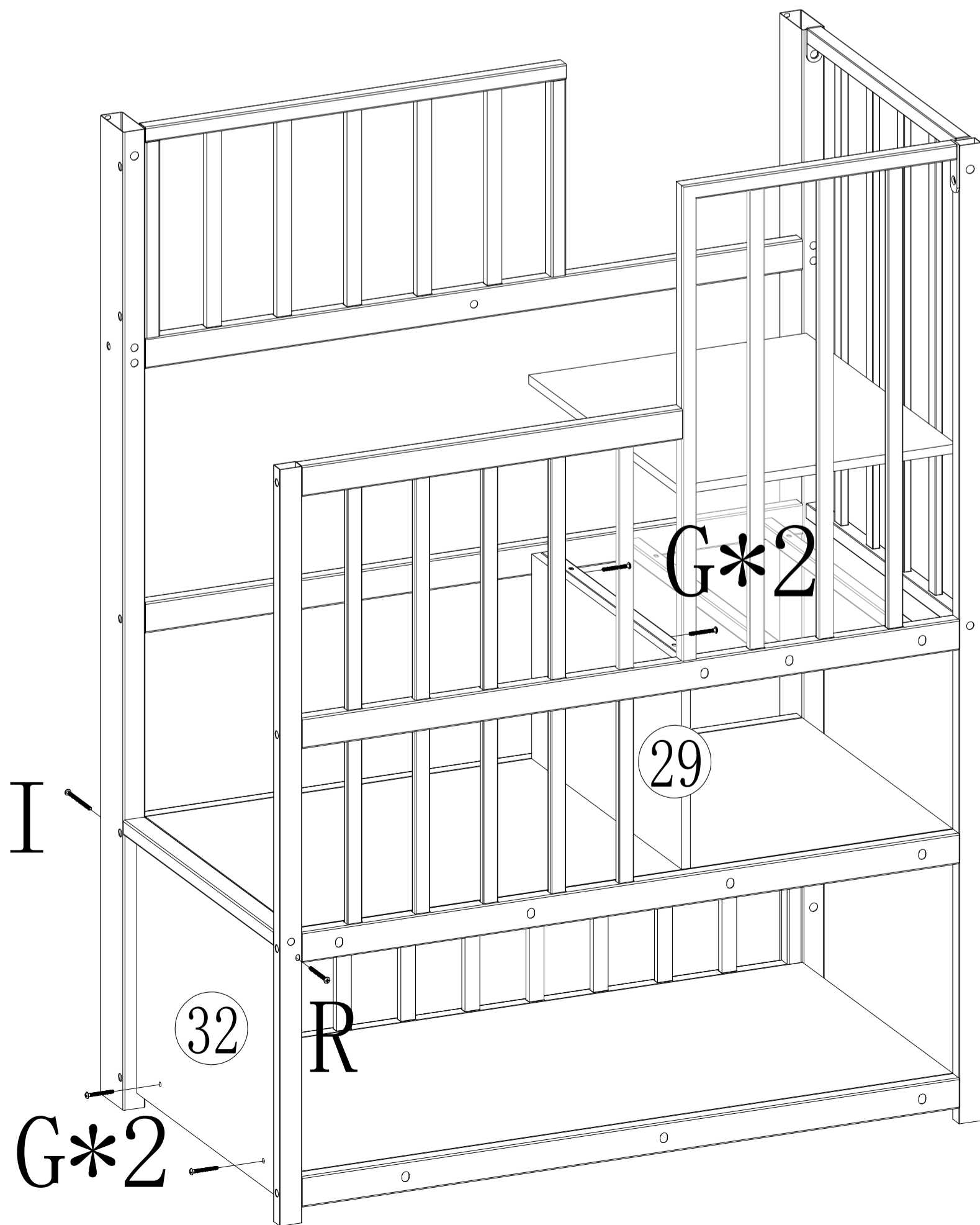

M

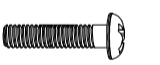

M4\*25mm

G × 4PCS



M4\*35mm

R × 1PCS



M4\*85mm

I × 1PCS

7

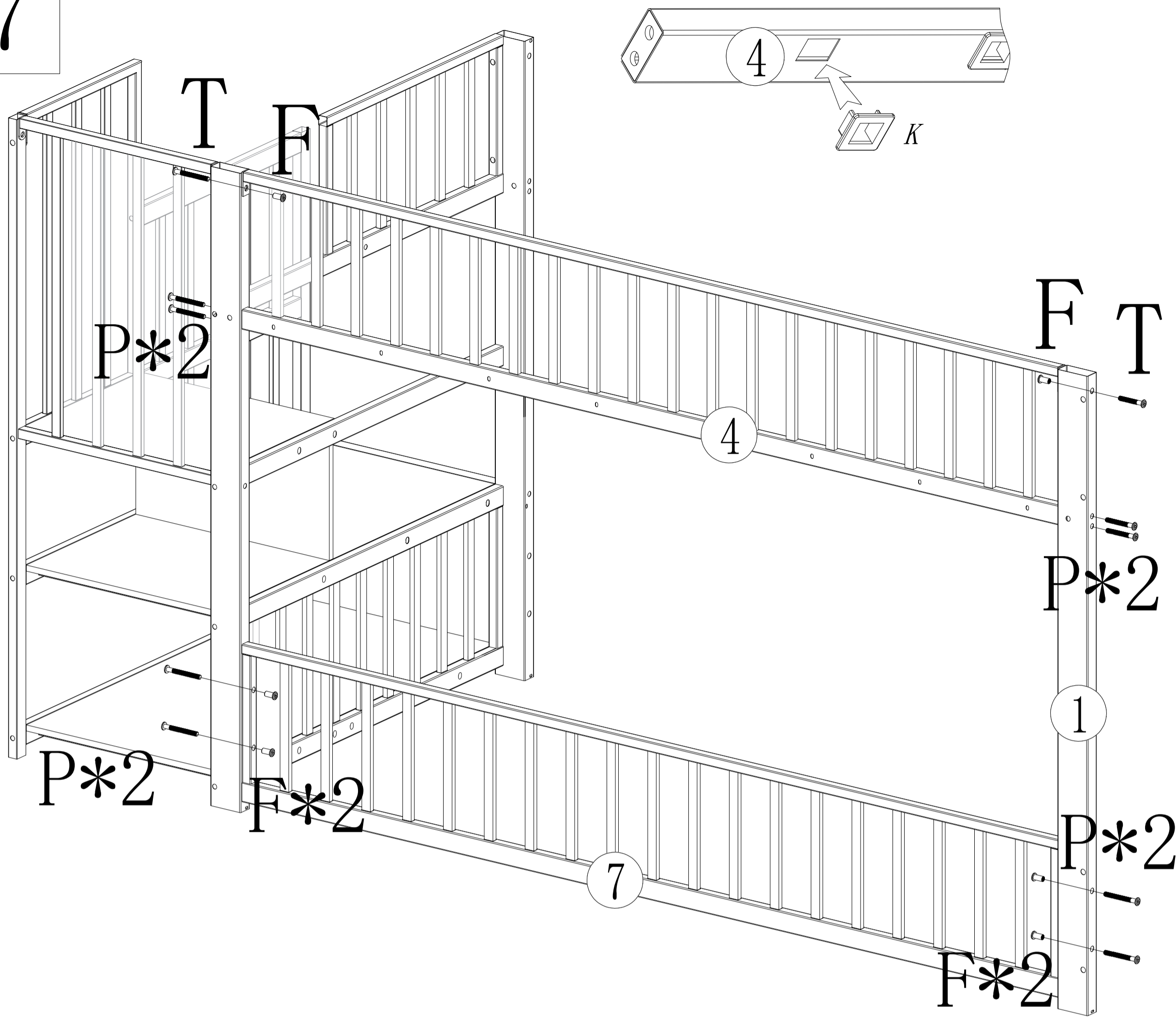

L



M8\*85mm

P × 8PCS



M8\*20mm

F × 6PCS



M8\*65mm

T × 2PCS

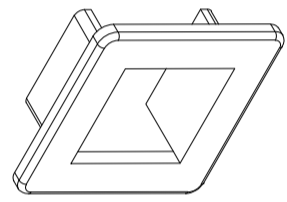

K × 22PCS

8

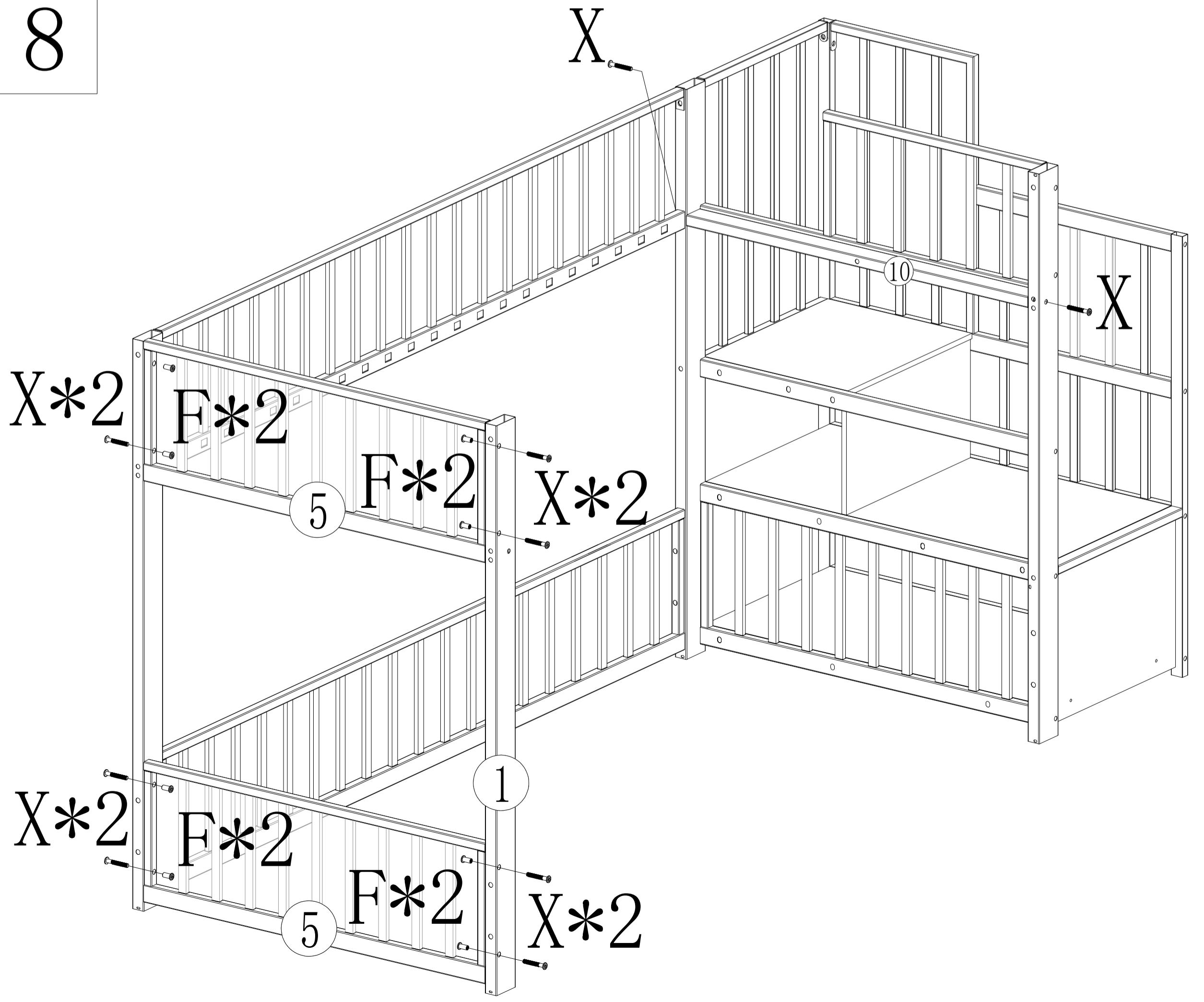

L

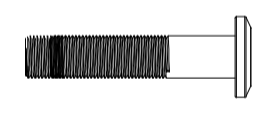

M8\*45mm

X × 10PCS



M8\*20mm

F × 8PCS

9

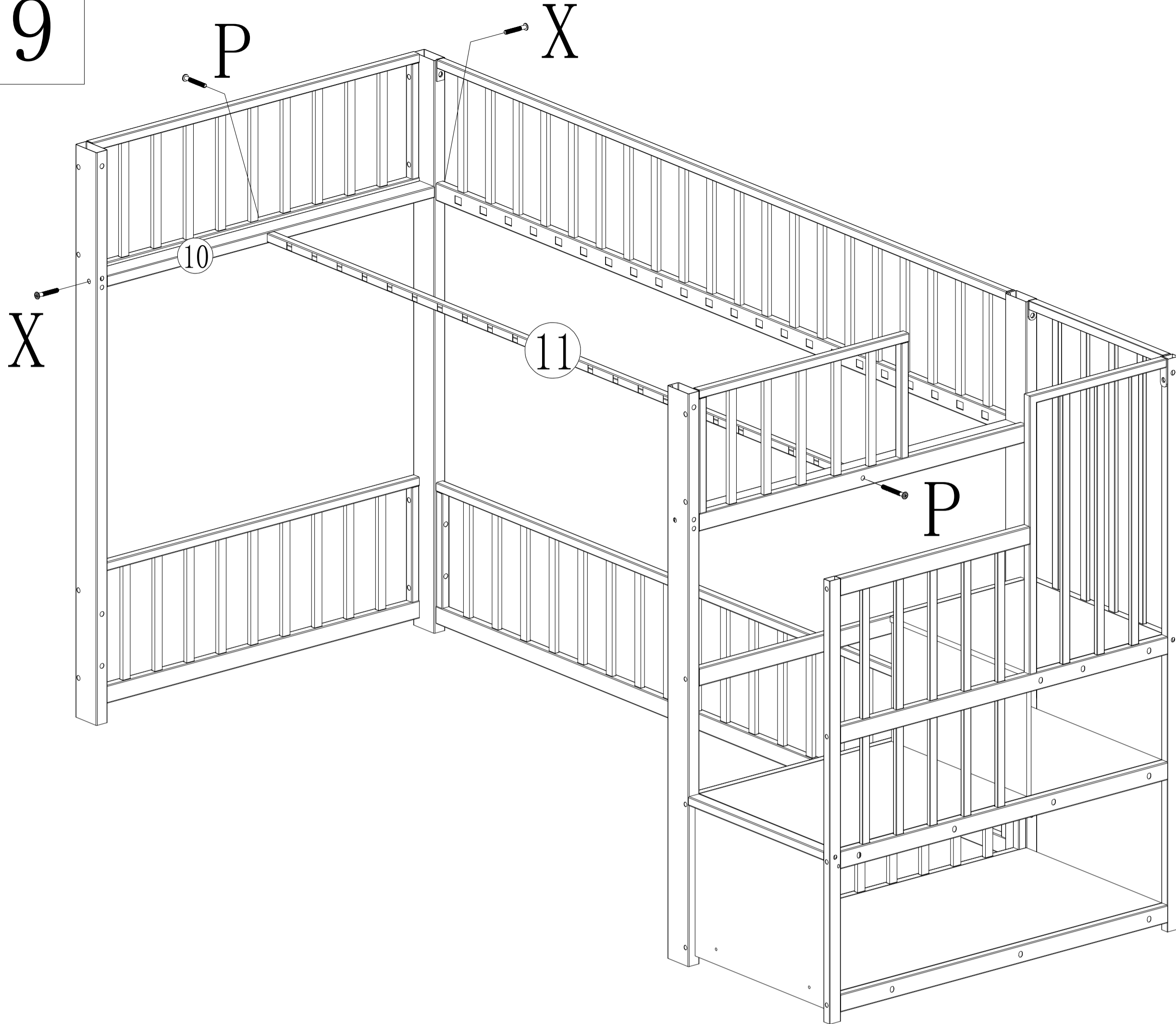

L

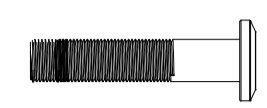

M8\*45mm

X × 2PCS



M8\*85mm

P × 2PCS

10

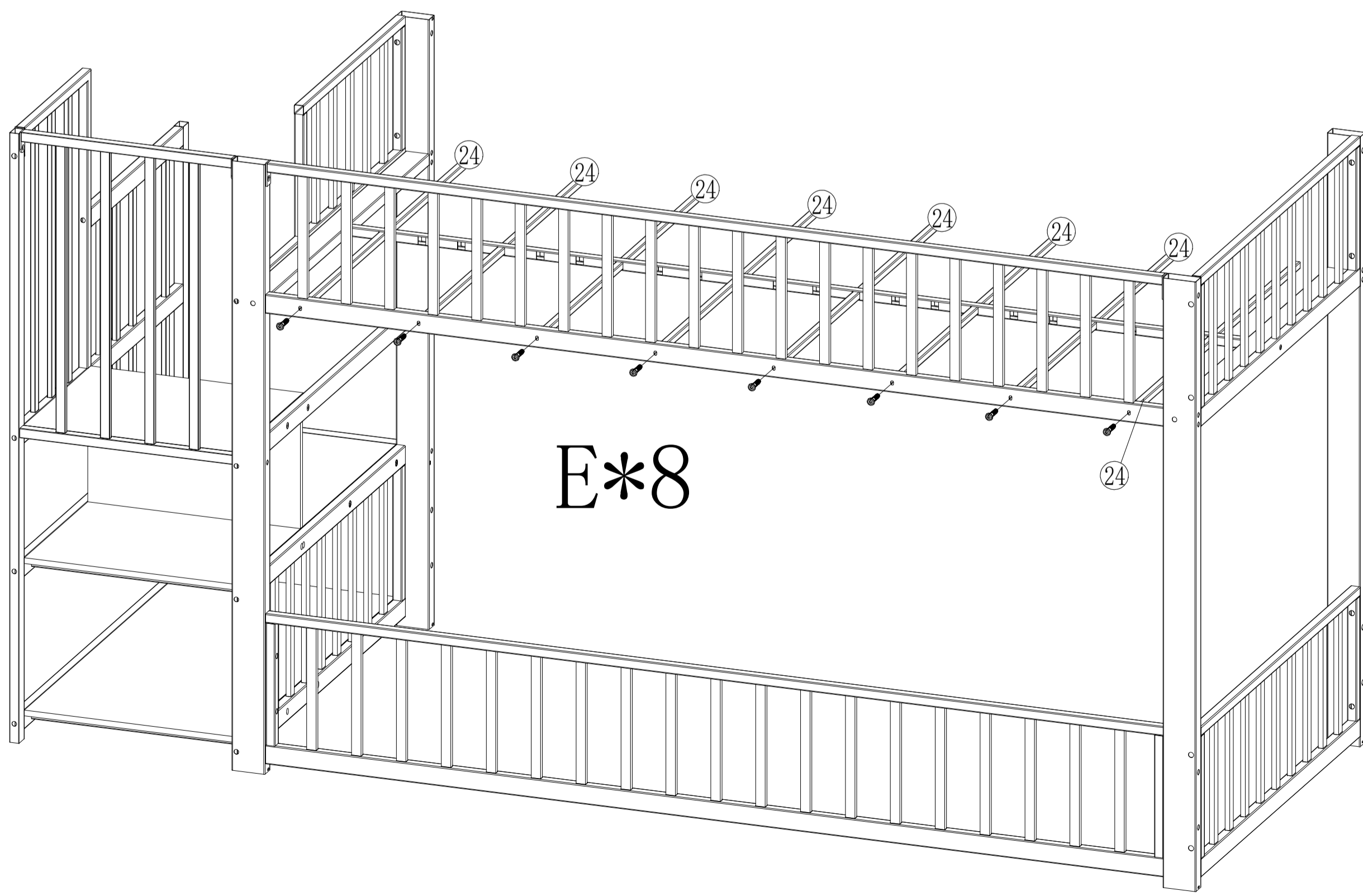

M

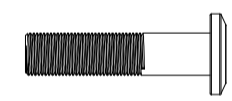

M6\*25mm

E × 8PCS

11

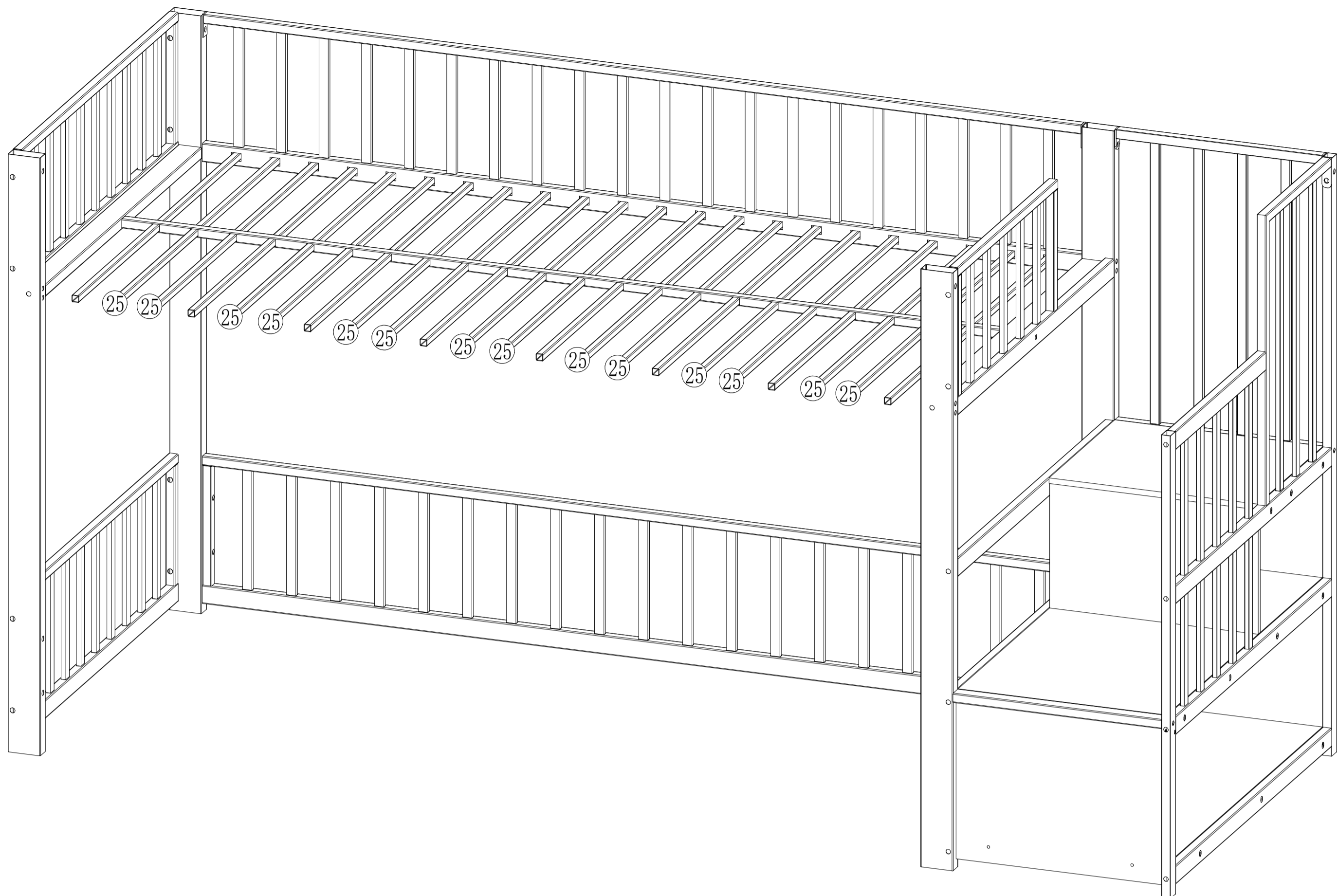

12

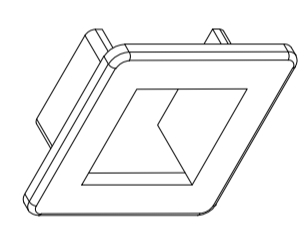
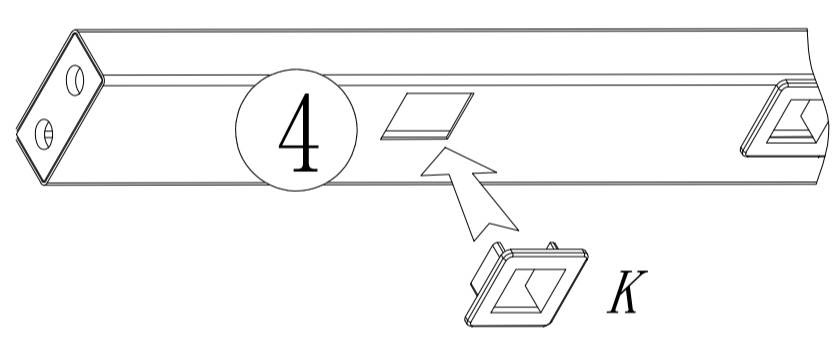

$K \times 22\text{PCS}$

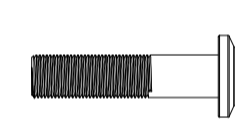

M6\*25mm

$E \times 8\text{PCS}$



L

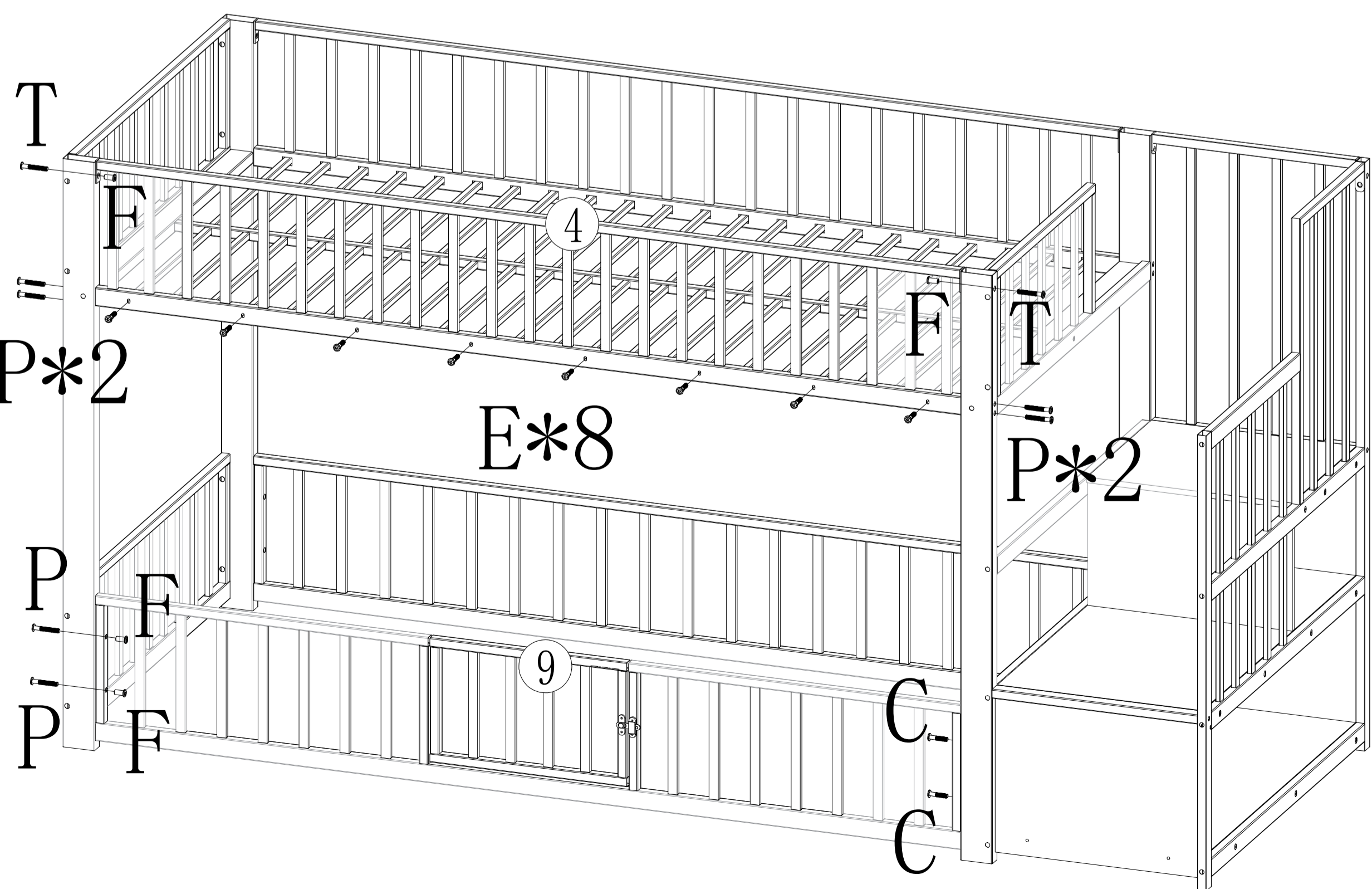

M8\*65mm

$T \times 2\text{PCS}$

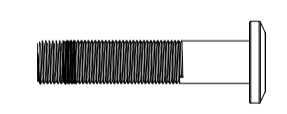

M8\*35mm

$C \times 2\text{PCS}$

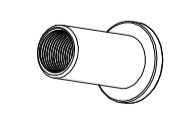

M8\*20mm

$F \times 4\text{PCS}$

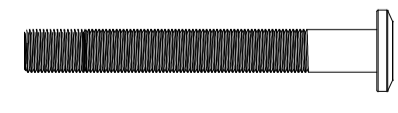

M8\*85mm

$P \times 6\text{PCS}$

13



Q

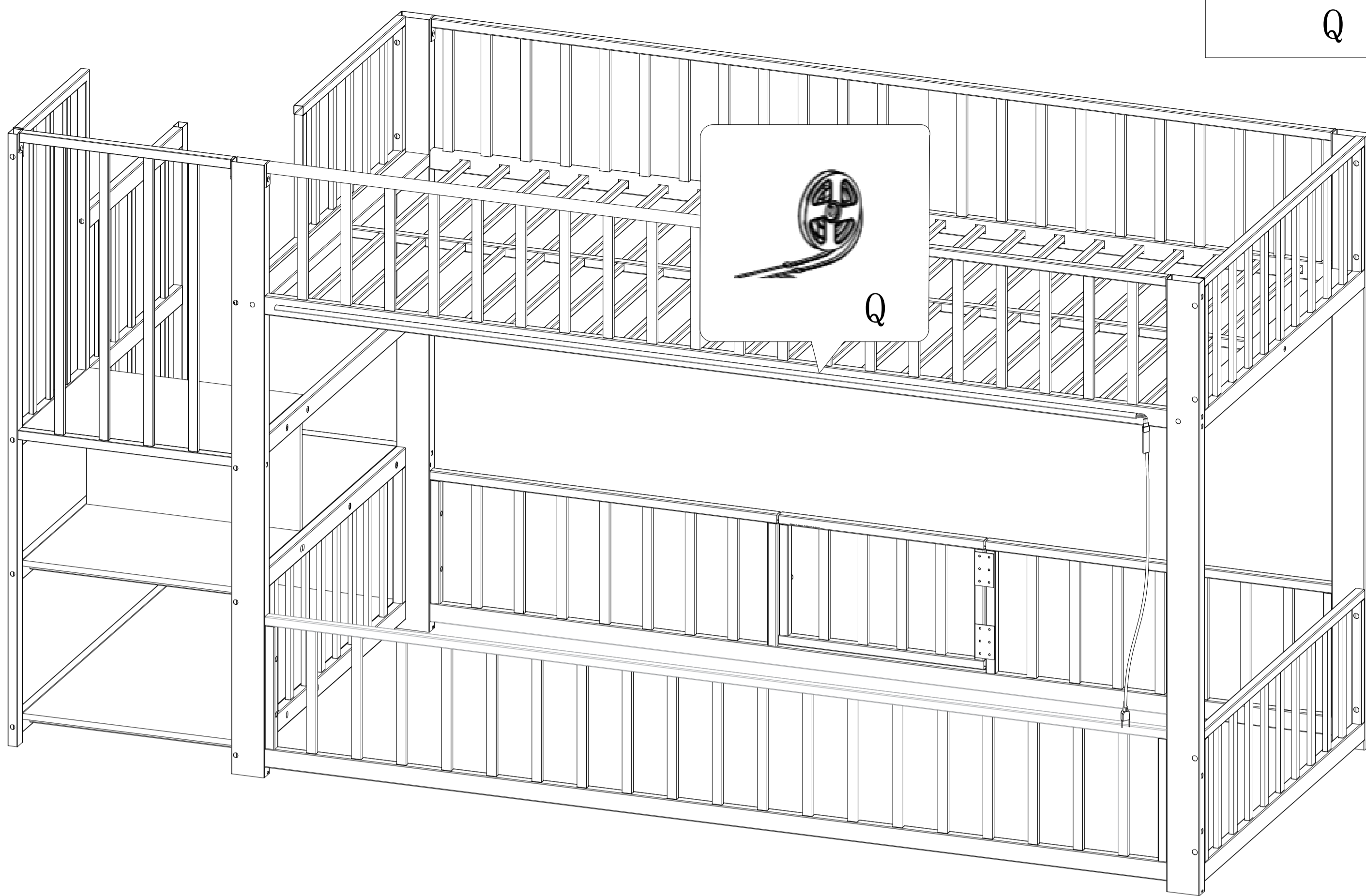

14

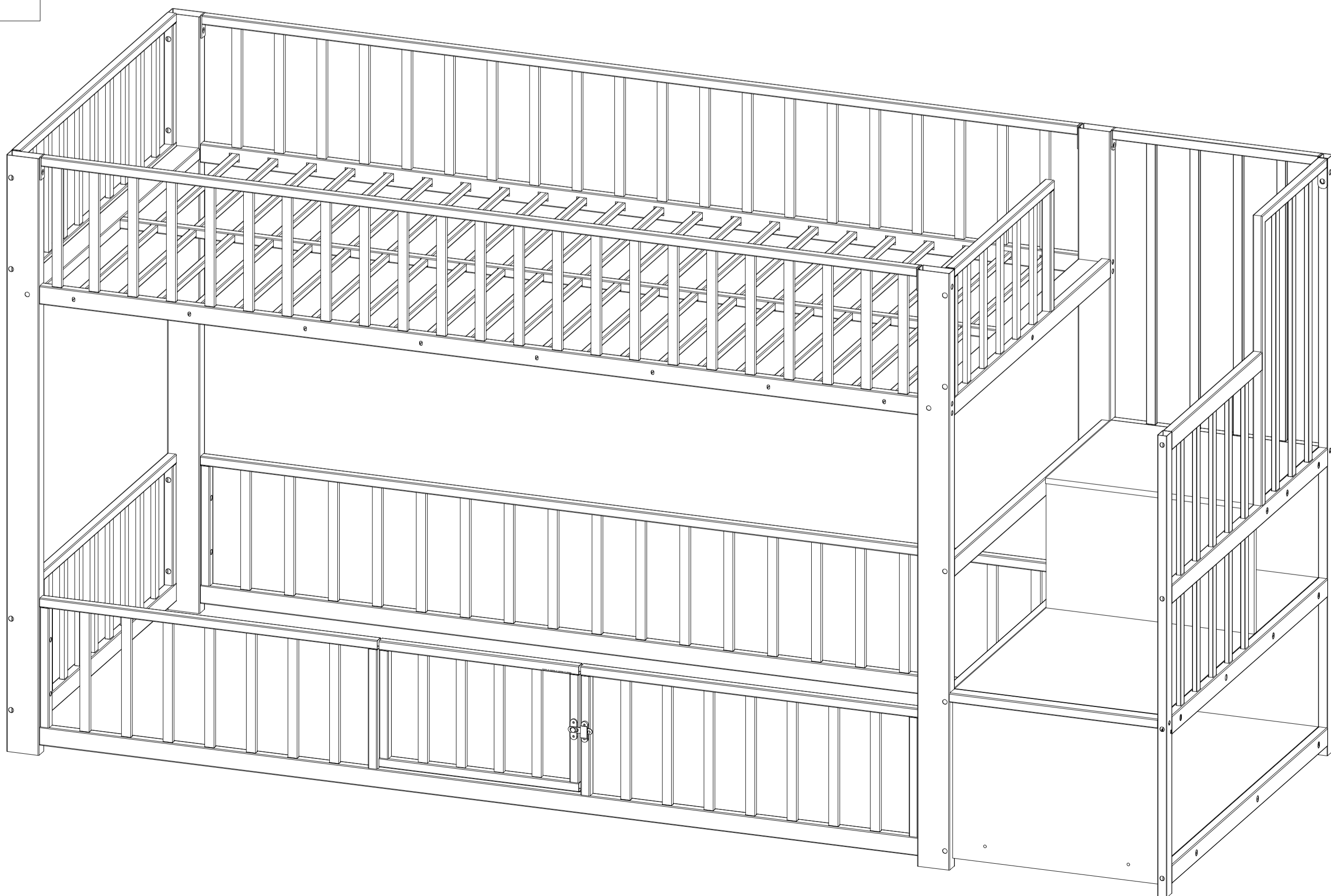



# Shenzhen GUOREN Certification Technology Service Co.,Ltd.

## Declaration of LVD Conformity

Certification number: GRCTC241204027

In accordance with the following Applicable Directives:

**2014/35/EU**

Applicant: Shenzhen Chengjie Lighting Co., Ltd  
 Address: B502 Bay Area Digital Warehouse, Taoyuan Community, Dalang Street, Longhua District, Shenzhen City  
 Manufacturer: Shenzhen Chengjie Lighting Co., Ltd  
 Address: B502 Bay Area Digital Warehouse, Taoyuan Community, Dalang Street, Longhua District, Shenzhen City  
 Product: neon lamp  
 Model: 5050

Laboratory: Shenzhen GUOREN Certification Technology Service Co., Ltd.  
 101#, Building K & Building T, The Second Industrial Zone, Jiazitang Community, Fenghuang Street, Guangming District, Shenzhen, China  
 Tel: 0755-23408306 Fax: 0755-23408309  
 http://www.grcert.com E-mail: grct\_sa@grcert.com

The test sample of product has been passed, the test according to requirements of the following standards:

Standard(s):	Test report(s) No.:
EN 60598-2-20:2015 used in conjunction with EN IEC 60598-1:2021 + A11:2022	GRCTR241204027

The certification is only valid for the equipment and configuration described in conjunction with the test data detailed above. The CE mark as shown beside can be used, under the responsibility of the manufacturer, after completion of an EC Directive of Conformity and compliance with all relevant EC Directive.



Approved by:

Department Manager

Date: Jan. 06, 2025

