

N634P249020











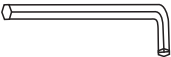

N634P249021

Installationsanleitung



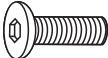

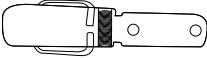
Installation Instruction

Instruction d'installation

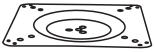

Hardware List-Hardware-Liste-Liste du matériel-N634P249020

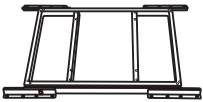

ELEMENTS/PARTS		Ax10  M8x24x2.0mm	B1x16  M6	B2x10  M8	
Cx6  M8x30mm	Dx1  #6	Ex16  M6x16x1.5mm	Fx16  M6x16mm	Gx1  #5	
Hx4  M8x16mm	Ix4 	Jx4 	Kx16 		

Part List-Teileliste-Liste des pièces-N634P249020

1 	2 	3 	6 	7 
---	---	---	--	---

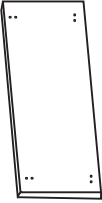
Part List-Teileliste-Liste des pièces-N634P249021

4 	5 	8 
---	---	---

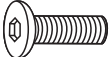
	Cx6	Fx16	Hx4
ELEMENTS/PARTS			
	M8x30mm	M6x16mm	M8x16mm

DE:Bitte beachten Sie, dass die Formen der Schrauben

C und F und H ähnlich sind. Bitte installieren Sie entsprechend

der Anleitung und unterscheiden Sie sie!

UK:Please note that the shapes of screws C and F and H are similar.

Please install according to the instructions and distinguish them!

FR:Notez que les vis C et F et H ont des formes similaires. Veuillez

les installer en suivant les instructions pour les séparer!

DE: Vor dem Einbau die Schrauben in die Löcher stecken und festziehen, aber nicht bis 100%, 70% bis 80% anziehen reicht aus. Schließlich, nachdem alle Schrauben installiert sind, ziehen Sie alle Schrauben auf 100%. Wenn Sie auf diese Probleme stoßen, wie z. B. Fehlausrichtung der Löcher oder Unfähigkeit, bestimmte Teile zu installieren, überprüfen Sie bitte, ob die Schrauben korrekt verwendet werden und passen Sie die Dichtigkeit der Schrauben an.

UK: Before installation, insert the screws into the holes and tighten them, but do not tighten them to 100%, 70% to 80% is sufficient. Finally, after all screws are installed, tighten all screws to 100%. If you encounter these issues, such as if the holes cannot be aligned or some parts cannot be installed, please check if the screws are used correctly and adjust the tightness of the screws.

FR: Insérer la vis dans le trou avant la fin de l'assemblage, serrer la vis, mais ne pas serrer à 100%, 70% ~ 80% est correct. Enfin, une fois que toutes les vis sont bien serrées, toutes les vis sont serrées à 100%. Si vous rencontrez ces problèmes, par exemple si les trous ne sont pas alignés ou si certaines pièces ne peuvent pas être montées, vérifiez que les vis sont utilisées correctement et Ajustez leur serrage.

1

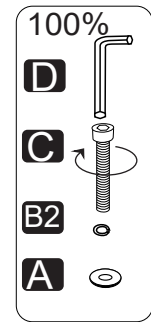
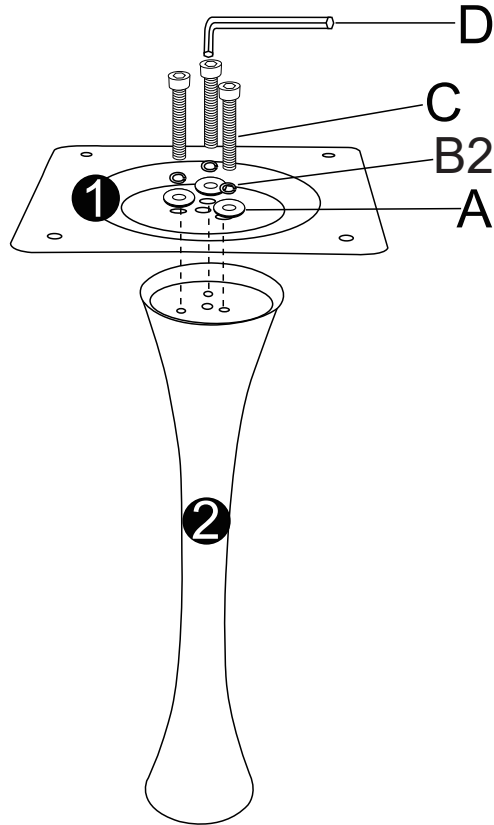

A		3PCS
B2		3PCS
C		3PCS
D		1PC

2

Wenn Sie zwei Tischplatten anschließen und sperren möchten, müssen Sie diesen Schalter ausschalten. Wenn Sie zwei Tischplatten trennen möchten, müssen Sie diesen Schalter öffnen

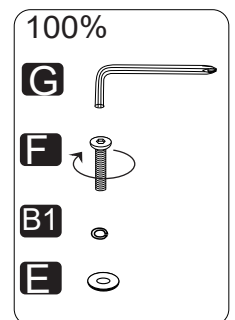
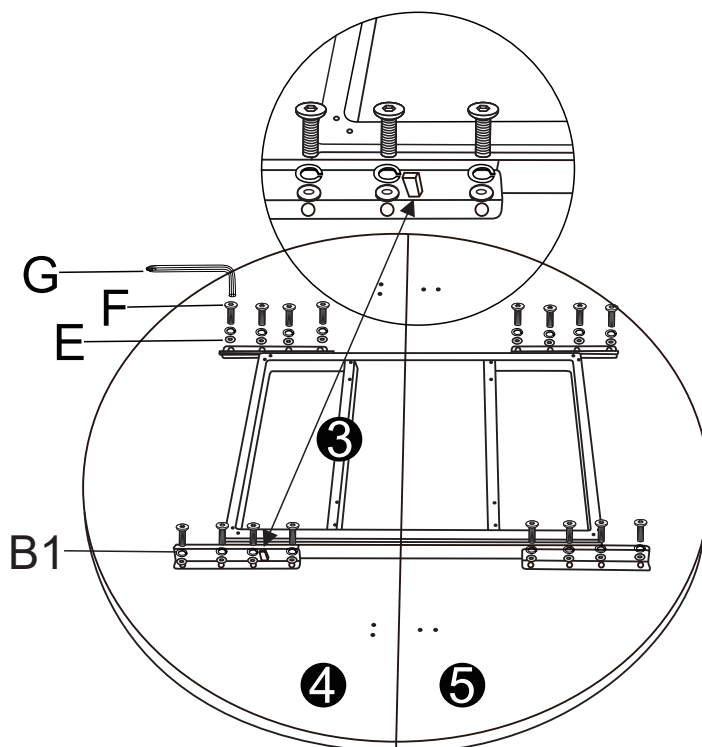

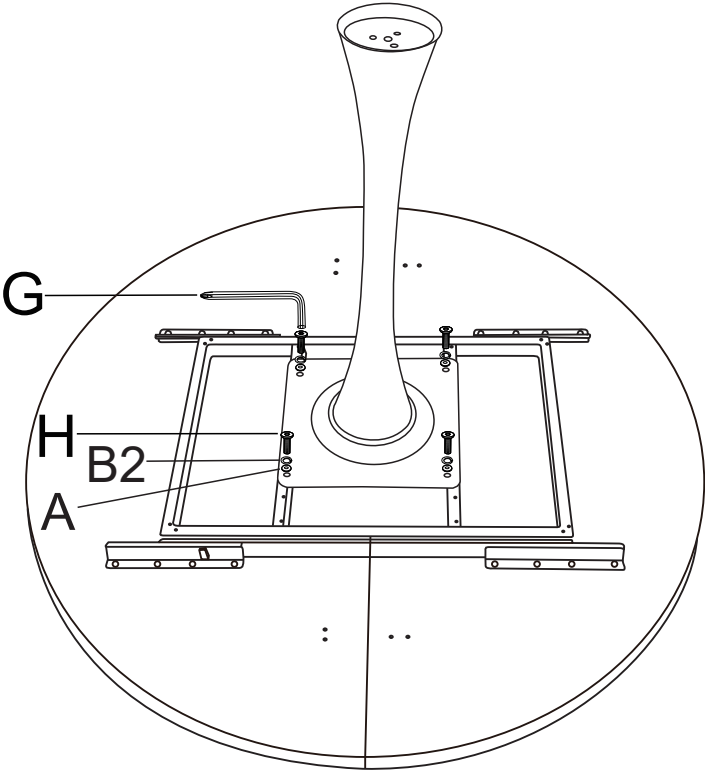

B1		16PCS
E		16PCS
F		16PCS
G		1PC

3







100%

G 

H 

B2 

A 

A		4PCS
	M8x24x2.0mm	
B2		4PCS
	M8	
G		1PC
	#5	
H		4PCS
	M8x16mm	

4

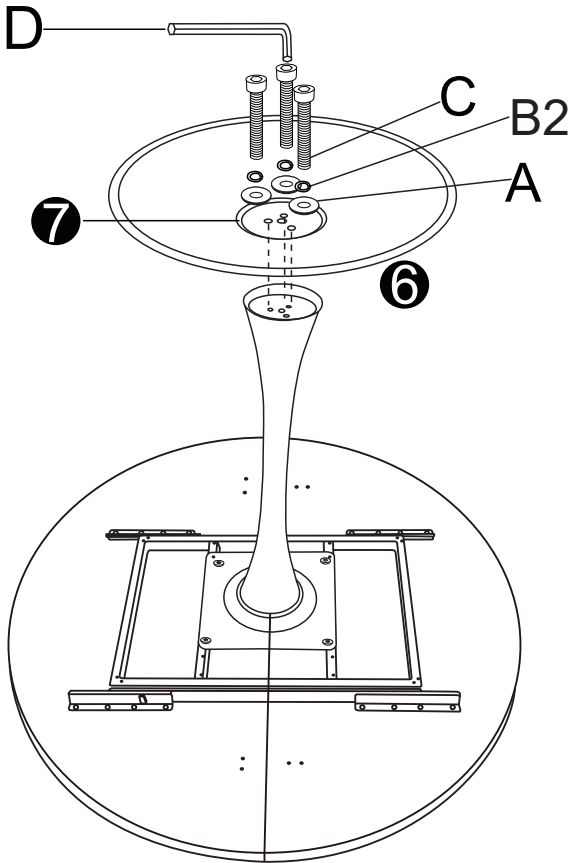





100%

D 

C 

B2 

A 

A		3PCS
	M8x24x2.0mm	
B2		3PCS
	M8	
C		3PCS
	M8x30mm	
D		1PC
	#6	

5

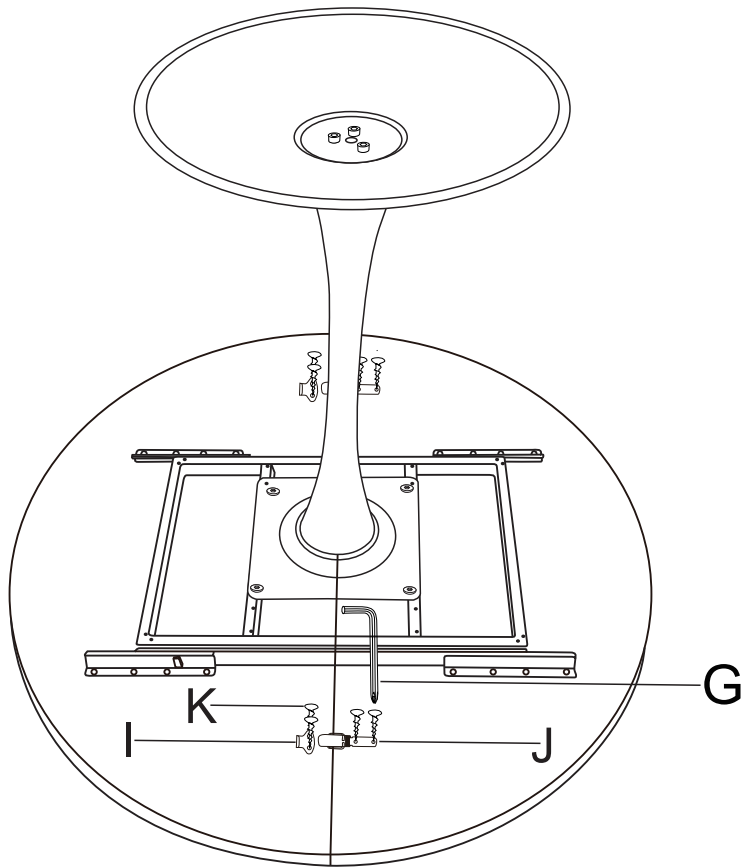

100%

G 

K 





I 

100%

G 

K 

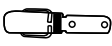
J 

G	 #5	1PC
I		2PCS
J		2PCS
K		8PCS

6

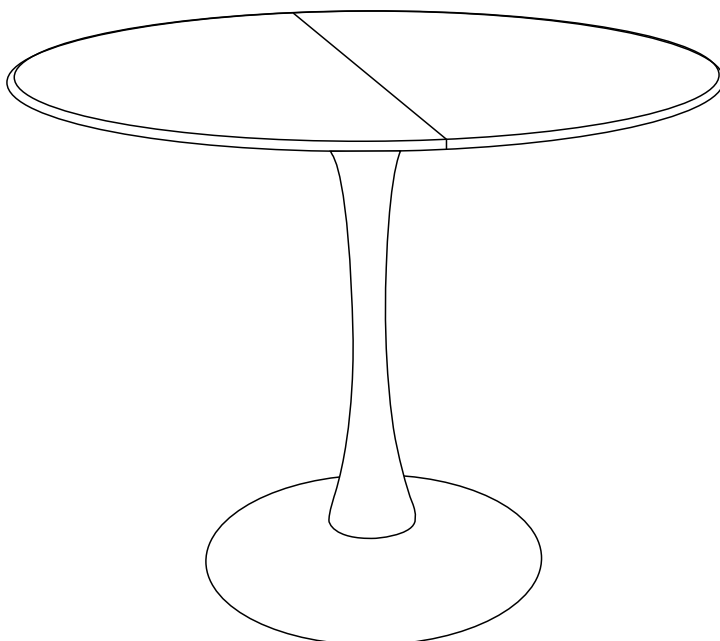

7

Wenn Sie den runden Tisch als ovaler Tisch ändern möchten, müssen Sie die folgenden Montageschritte befolgen.

Öffnen Sie zuerst die mit dem Desktop J angeschlossene Komponente J und den schwarzen festen Schalter und dehnen Sie die eingefügten Teile ⑧ aus, setzen Sie den nächsten Installationschritt fort

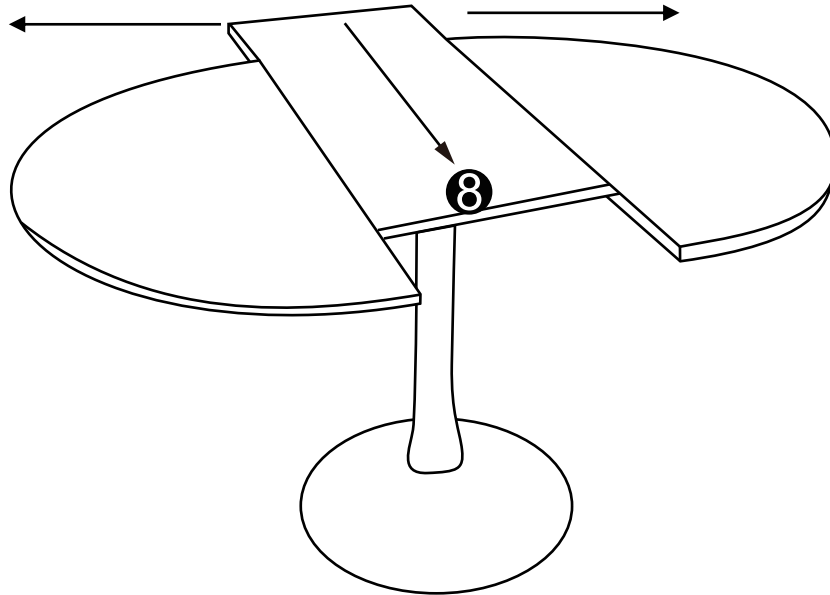

8

Wenn sie die arbeitsfläche miteinander verbinden, sind bauelemente J und bauteil I miteinander verbunden

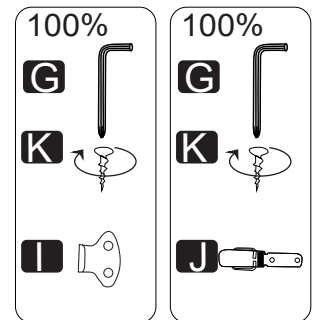
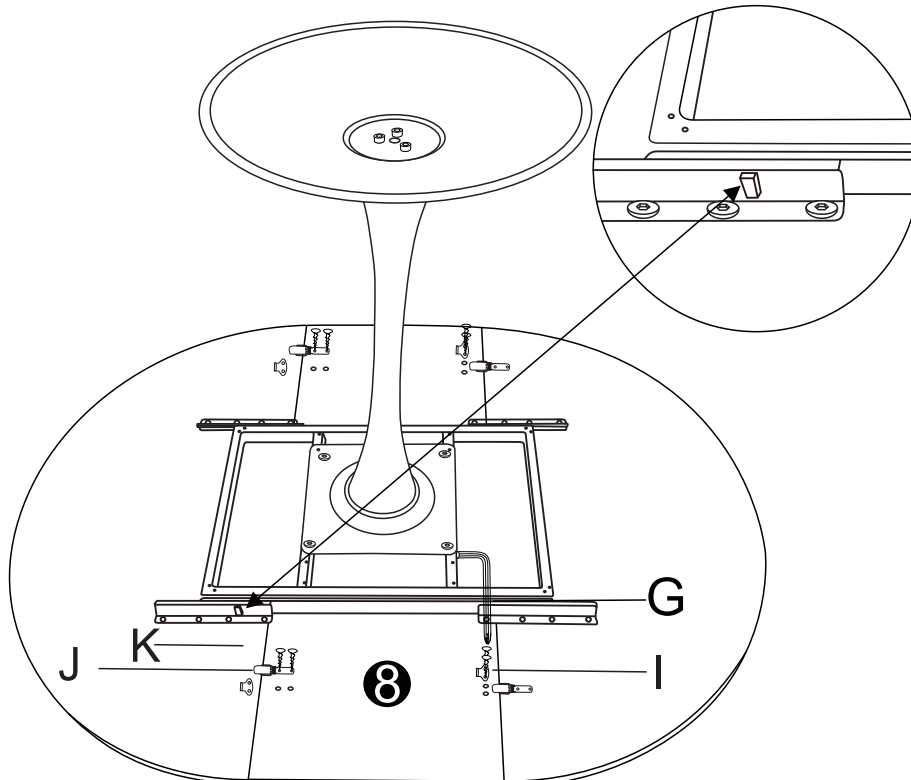

G		1PC
I		2PCS
J		2PCS
K		8PCS

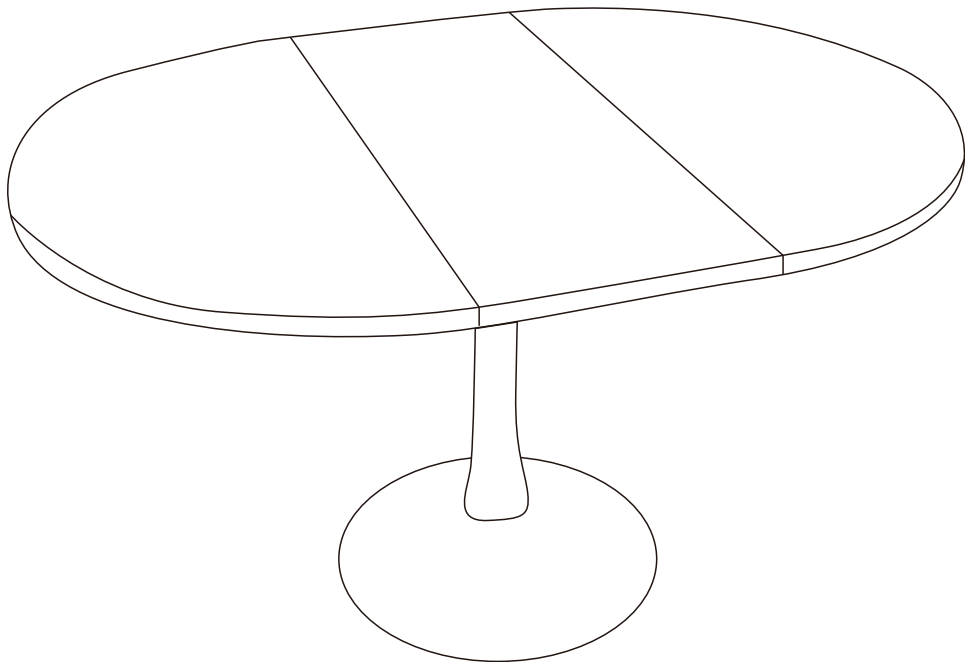
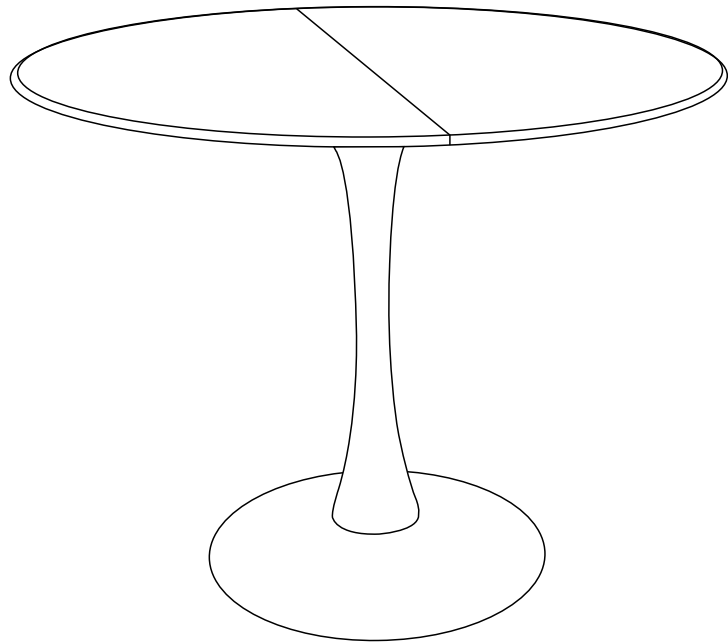

DE

Warnung

- 1 Die maximale Tragfähigkeit des Produkts beträgt 100 kg. Überladen vermeiden.
- 2 Kinder dürfen nicht auf Möbel klettern, da dies zu Kippen und schweren Verletzungen führen kann.
- 3 Um die Sicherheit zu gewährleisten, installieren Sie bitte gemäß den Anweisungen korrekt und holen Sie bei Bedarf professionelle Hilfe ein.
- 4 Stellen Sie Möbel nicht in der Nähe von Wärmequellen oder heißen Gegenständen auf, um Brandgefahr zu vermeiden.
- 5 Vermeiden Sie es, Möbel in feuchten Umgebungen zu platzieren, um Materialschäden zu vermeiden.
- 6 Überprüfen Sie regelmäßig alle Verbindungsstücke und Befestigungen, um sicherzustellen, dass sie fest sitzen und unerwartete Unfälle zu verhindern.
- 7 Reinigen Sie Möbel mit einem feuchten Tuch oder Alkohol, vermeiden Sie die Verwendung von Reinigungsmitteln, die ätzende Chemikalien enthalten.

UK

Warning

- 1 The maximum load capacity of the product is 100 kg. Do not overload.
- 2 Children should not climb on furniture, as this may cause tipping and serious injuries.
- 3 To ensure safety, please install according to the instructions correctly, and seek professional assistance if necessary.
- 4 Do not place furniture near heat sources or hot items to avoid the risk of fire.
- 5 Do not place furniture in damp environments to prevent material damage.
- 6 Regularly check all connections and fasteners to ensure they are secure to prevent accidents.
- 7 Clean furniture with a damp cloth or alcohol, avoid using cleaning agents containing corrosive chemicals.

FR

Avertissement

- 1 La charge maximale du produit est de 100 kg. Ne pas surcharger.
- 2 Veuillez ne pas laisser les enfants grimper sur les meubles, car cela peut entraîner un basculement et des blessures graves.
- 3 Pour assurer la sécurité, veuillez installer correctement selon les instructions et demander une assistance professionnelle si nécessaire.
- 4 Ne placez pas les meubles près de sources de chaleur ou d'objets chauds pour éviter les risques d'incendie.
- 5 Évitez de placer les meubles dans des environnements humides pour éviter les dommages aux matériaux.
- 6 Vérifiez régulièrement toutes les connexions et les fixations pour vous assurer qu'elles sont sécurisées et prévenir les accidents.
- 7 Nettoyez les meubles avec un chiffon humide ou de l'alcool, évitez d'utiliser des agents de nettoyage contenant des produits chimiques corrosifs.

IT

Avviso

- 1 La capacità massima del prodotto è di 100 kg. Non sovraccaricare.
- 2 I bambini non devono arrampicarsi sui mobili, poiché ciò potrebbe causare il ribaltamento e gravi lesioni.
- 3 Per garantire la sicurezza, installare correttamente secondo le istruzioni e chiedere assistenza professionale se necessario.
- 4 Non posizionare i mobili vicino a fonti di calore o oggetti caldi per evitare il rischio di incendio.
- 5 Evitare di posizionare i mobili in ambienti umidi per evitare danni ai materiali.
- 6 Controllare regolarmente tutte le connessioni e i fissaggi per assicurarsi che siano sicuri e prevenire gli incidenti.
- 7 Pulire i mobili con un panno umido o alcool, evitare l'uso di agenti di pulizia contenenti sostanze chimiche corrosive.

ES

Aviso

- 1 La capacidad máxima de carga del producto es de 100 kg. No sobrecargar.
- 2 Los niños no deben trepar sobre los muebles, ya que esto puede causar que se vuelquen y provocar lesiones graves.
- 3 Para garantizar la seguridad, instale correctamente según las instrucciones y busque asistencia profesional si es necesario.
- 4 No coloque los muebles cerca de fuentes de calor o objetos calientes para evitar el riesgo de incendio.
- 5 Evite colocar los muebles en entornos húmedos para evitar daños en los materiales.
- 6 Revise regularmente todas las conexiones y sujeciones para asegurarse de que estén seguras y prevenir accidentes.
- 7 Limpie los muebles con un paño húmedo o alcohol, evite el uso de agentes de limpieza que contengan productos químicos corrosivos.