

ASSEMBLY INSTRUCTION

AX1

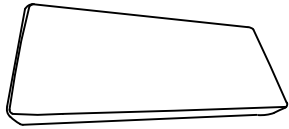

BX1



CX1

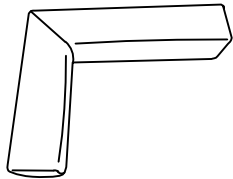

DX1

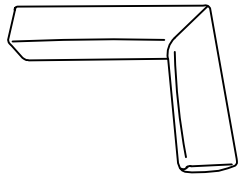

EX3

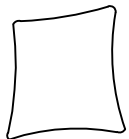

STEP 1

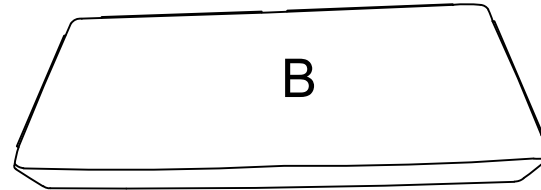

B

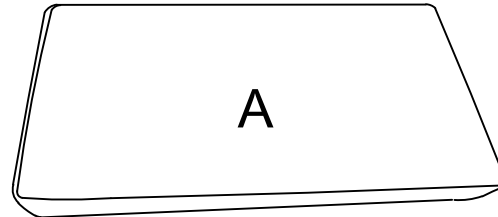

A

STEP 2

C

D

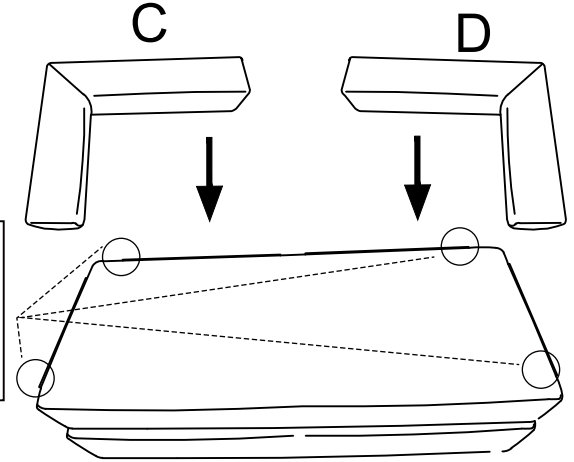
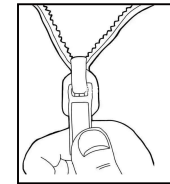

STEP 3

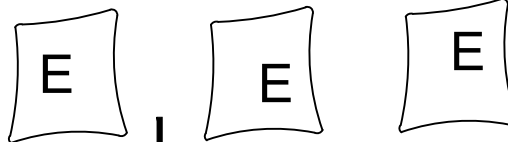

E

E

E

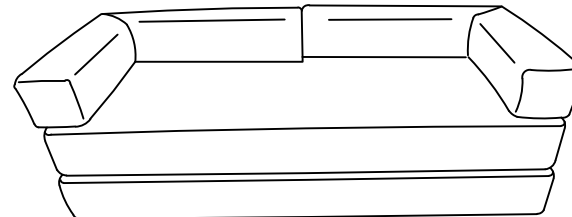

STEP 4

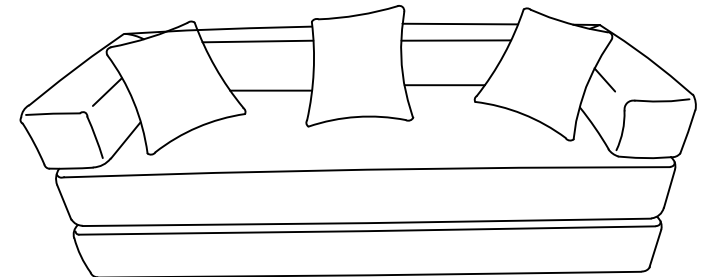

Can be placed in any shape

