



30 MIN



PL INSTRUKCJA MONTAŻU
 CZ MONTÁŽNY NÁVOD
 D MONTAGEANLEITUNG
 TR MONTAJ TALLMATI
 F NOTICE DE MONTAGE
 HU SZERELÉSI ÚTMUTATÓ

GB ASSEMBLY INSTRUCTIONS
 RU ИНСТРУКЦИЯ ПО МОНТАЖУ
 IT ISTRUZIONI DI MONTAGGIO
 SK NÁVOD NA MONTÁŽ
 RO INSTRUCȚIUNI DE MONTAJ
 NL HANDLEIDING VOOR DE MONTAGE

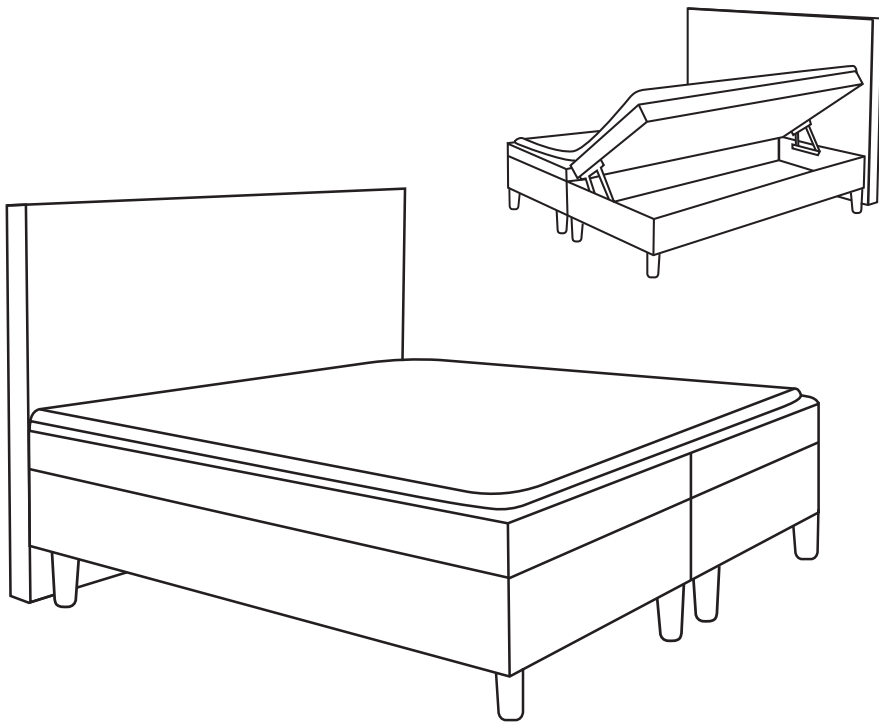

X 2

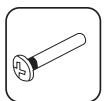

X 2

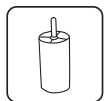

X 8

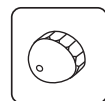

X 4

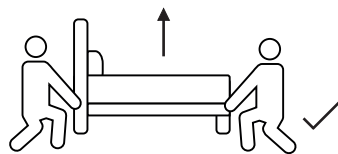
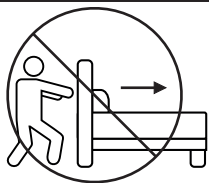

1



X 3

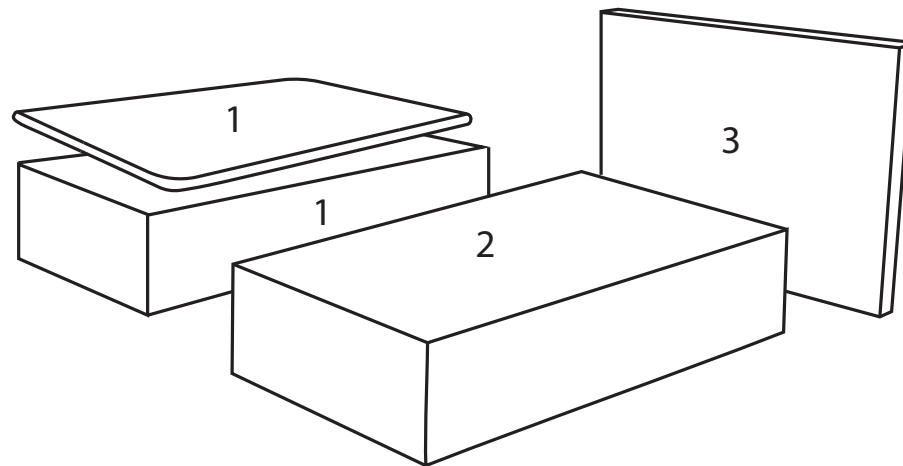

2



X 8

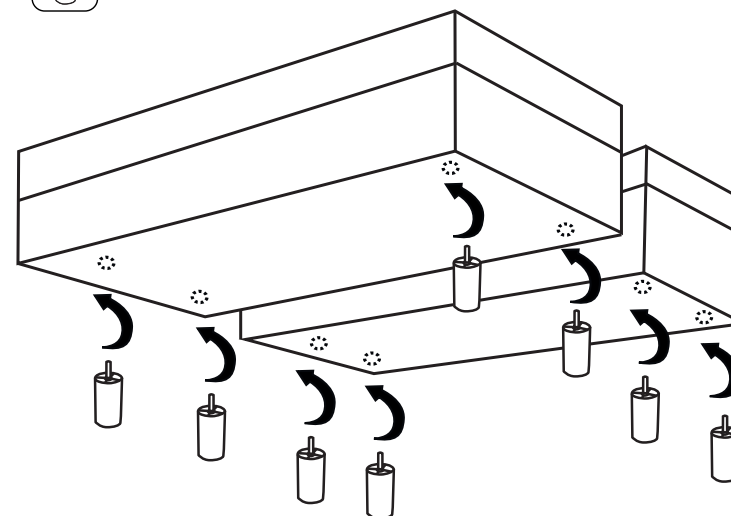

3

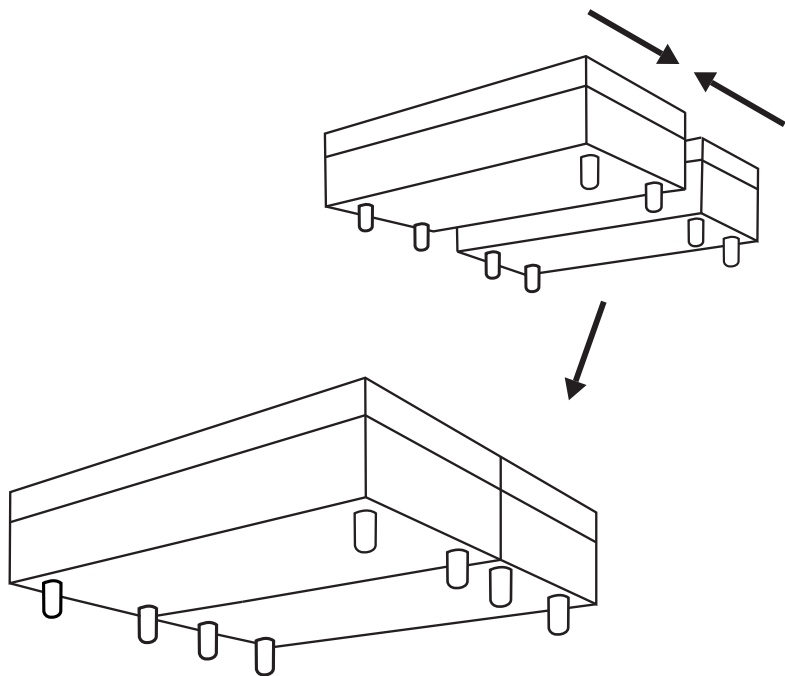

4

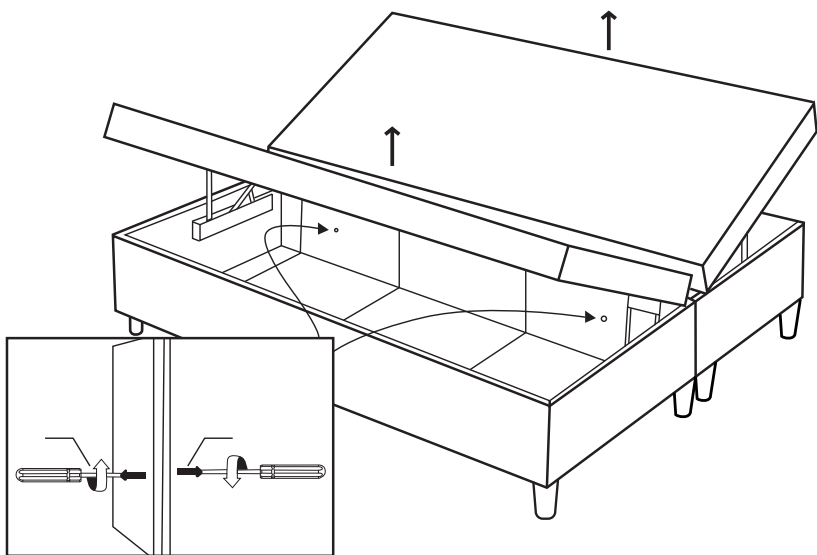

5

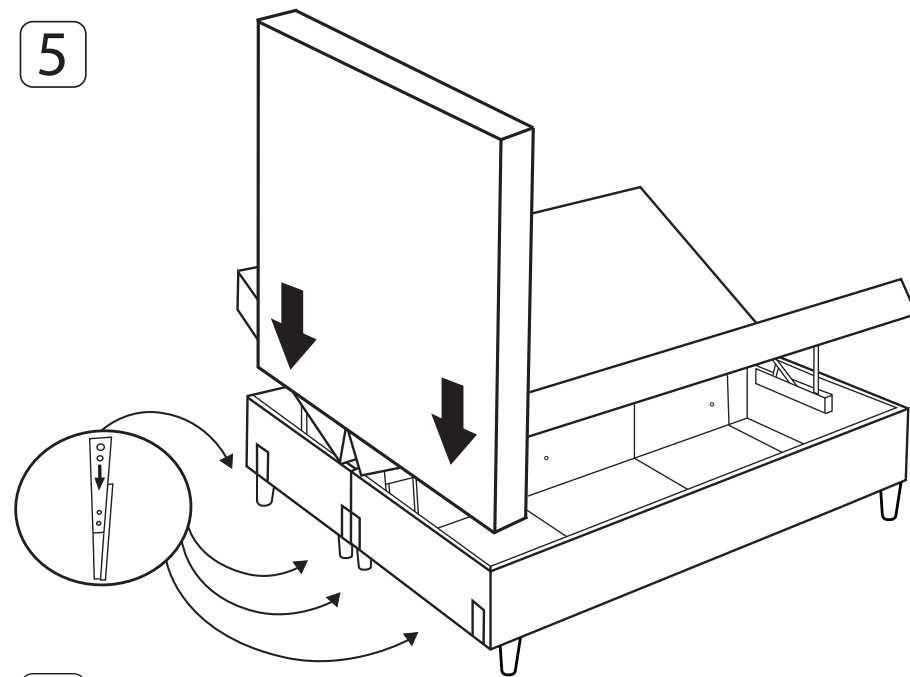

6

