

Installation sanleitung Installation Instruction Instruction d'installation

SKU:N636P223082

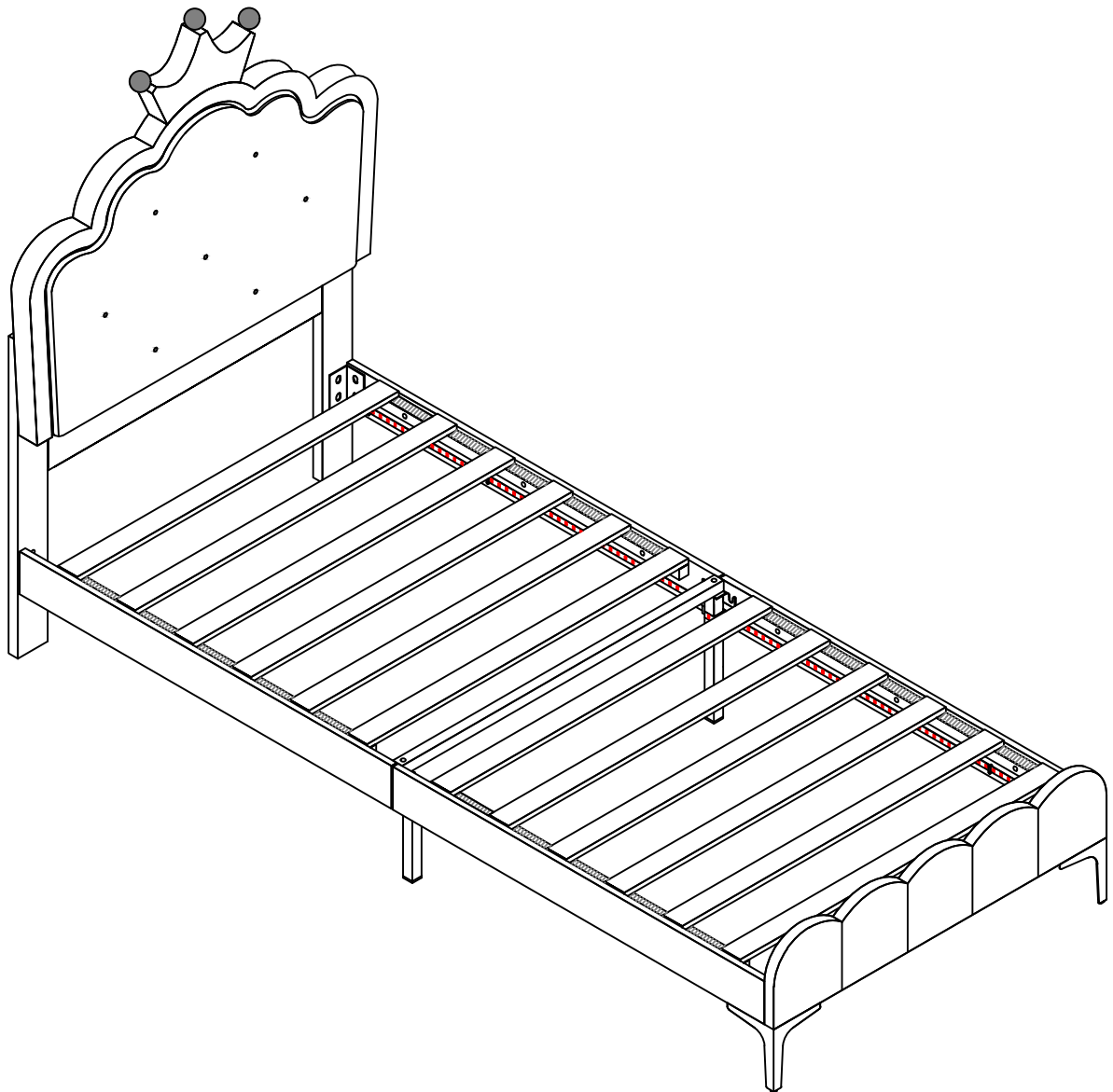

CE



English

IMPORTANT ! KEEP FOR FUTURE REFERENCE : READ CAREFULLY

- To be assembled by an adult. Assembly must be checked by an adult before use
- WARNING ! Keep all screws, small parts and plastic bags out of the reach of children
- Properly identify all parts before assembling
- Never use your item if any of its parts are broken or missing
- Should any problems arise, please contact our After Sales Service
- Manufacturer's instructions shall be followed at all times
- Care: Clean with a soft, dry cloth. In case of larger stains, carefully rub with a slightly damp, non-abrasive sponge
- Avoid the risk of fire by not placing furniture near sources of ignition or hot items
- Do not jump on the bed

Deutsch

WICHTIG ! ZUM SPÄTEREN NACHSCHLAGEN AUFBEWAHREN: SORGFÄLTIG LESEN

- Muss von einem Erwachsenen zusammengebaut werden. Der Zusammenbau muss vor dem Gebrauch von einem Erwachsenen überprüft werden
- WARNUNG! Bewahren Sie alle Schrauben, Kleinteile und Plastikbeutel außerhalb der Reichweite von Kindern auf
- Kennzeichnen Sie vor dem Zusammenbau alle Teile richtig
- Benutzen Sie Ihren Artikel niemals, wenn Teile gebrochen sind oder fehlen
- Sollten Probleme auftreten, wenden Sie sich bitte an unseren Kundendienst
- Die Anweisungen des Herstellers sind stets zu befolgen
- Pflege: Mit einem weichen, trockenen Tuch reinigen. Bei größeren Flecken vorsichtig mit einem leicht feuchten, nicht scheuernden Schwamm abreiben. nicht scheuernden Schwamm
- Vermeiden Sie die Gefahr eines Brandes, indem Sie die Möbel nicht in der Nähe von Zündquellen oder heißen Gegenständen aufstellen
- Nicht auf das Bett springen

Français

IMPORTANT ! CONSERVER POUR RÉFÉRENCE ULTÉRIEURE : LIRE ATTENTIVEMENT

- Le montage doit être effectué par un adulte. Le montage doit être vérifié par un adulte avant Utilisation
- ATTENTION ! Tenir les vis, les petites pièces et les sachets en plastique hors de portée des enfants
- Identifiez correctement toutes les pièces avant de les assembler
- N'utilisez jamais votre article si l'une de ses pièces est cassée ou manquante
- En cas de problème, veuillez contacter notre service après-vente
- Les instructions du fabricant doivent être respectées à tout moment
- Entretien : nettoyer avec un chiffon doux et sec. En cas de taches plus importantes, frotter soigneusement avec une éponge non abrasive légèrement humide. légèrement humide et non Abrasive
- Évitez les risques d'incendie en ne plaçant pas les meubles à proximité de sources d'inflammation ou d'objets chauds
- Ne pas sauter sur le lit

Italiano

IMPORTANTE! CONSERVARE PER RIFERIMENTO FUTURO: LEGGERE ATTENTAMENTE

- Deve essere assemblato da un adulto. L'assemblaggio deve essere controllato da un adulto prima dell'uso
- **ATTENZIONE!** Tenere tutte le viti, le piccole parti e i sacchetti di plastica fuori dalla portata dei bambini
- Identificare correttamente tutte le parti prima dell'assemblaggio
- Non utilizzare mai l'articolo se alcune parti sono rotte o mancanti
- In caso di problemi, si prega di contattare il nostro Servizio Post Vendita
- Le istruzioni del produttore devono essere sempre seguite
- Cura: Pulire con un panno morbido e asciutto. In caso di macchie più estese, strofinare accuratamente con una spugna leggermente umida e nonspugna leggermente umida e non abrasiva
- Evitare il rischio di incendio, non collocando i mobili vicino a fonti di accensione o a oggetti caldi
- Non saltare sul letto

Español

¡ IMPORTANTE ! CONSERVELO PARA FUTURAS CONSULTAS: LEA ATENTAMENTE

- Debe ser montado por un adulto. El montaje debe ser comprobado por un adulto antes del uso
- ADVERTENCIA Mantenga todos los tornillos, piezas pequeñas y bolsas de plástico fuera del alcance de los niños.
- Identifique correctamente todas las piezas antes de montarlas
 - Nunca utilice su artículo si alguna de sus piezas está rota o falta
 - Si surge algún problema, póngase en contacto con nuestro Servicio Postventa
 - Las instrucciones del fabricante deben seguirse en todo momento
 - Cuidado: Limpiar con un paño suave y seco. En caso de manchas más grandes, frote cuidadosamente con una esponja no abrasiva ligeramente humedecida.
 - Evite el riesgo de incendio no colocando los muebles cerca de fuentes de ignición u objetos calientes.
 - No saltar sobre la cama.

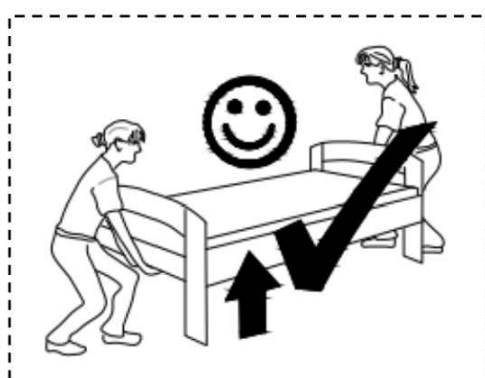



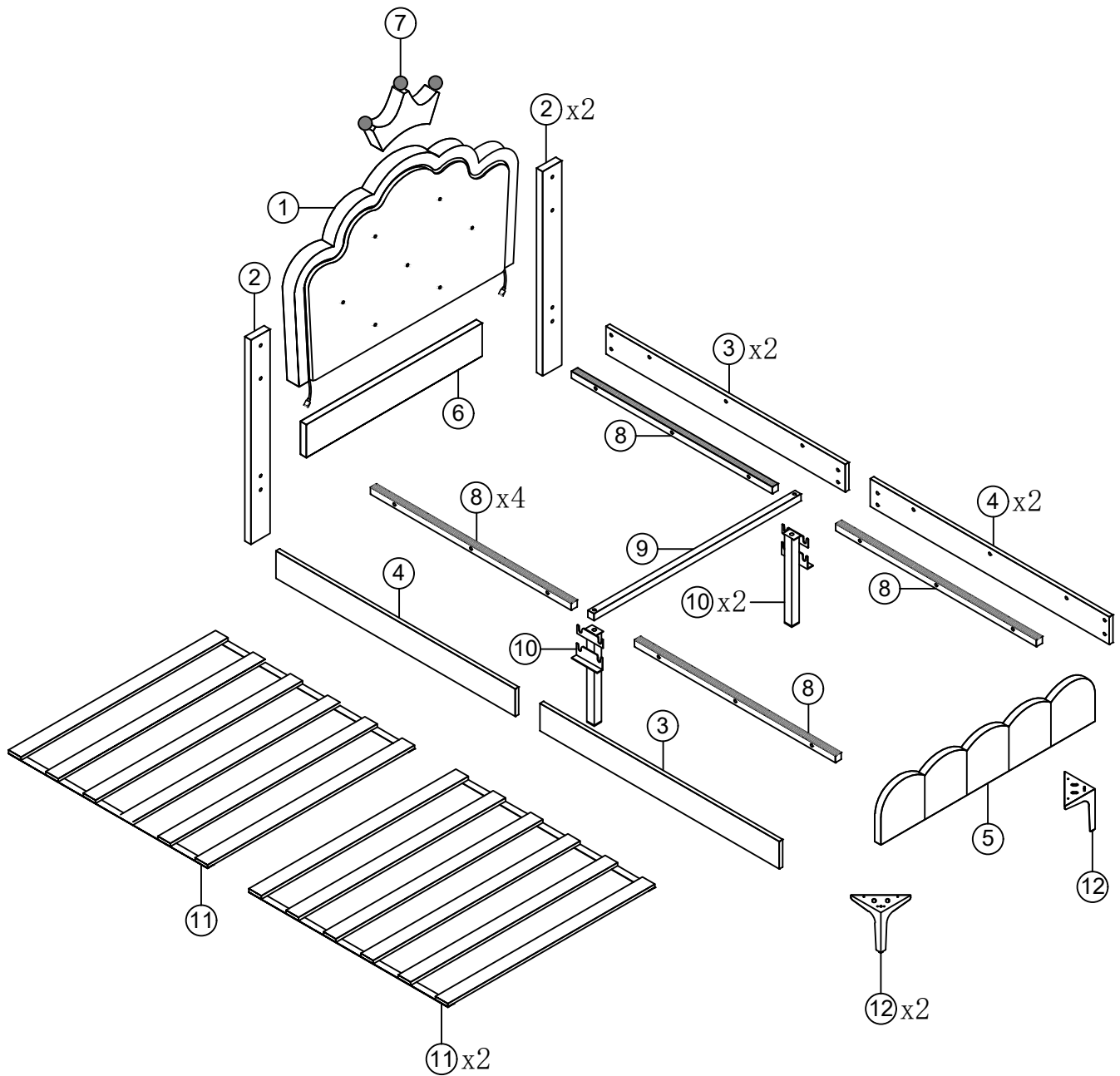



Detailansicht

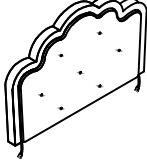

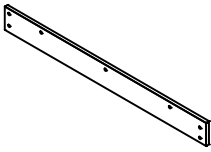
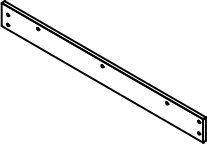

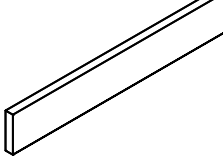
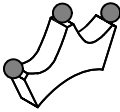
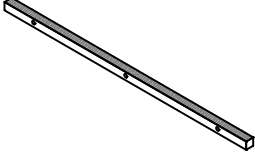
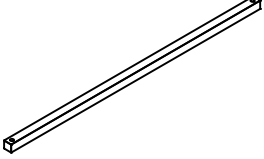

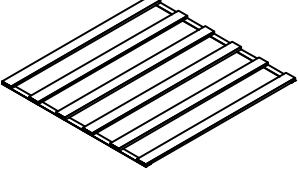
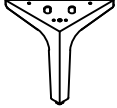



Liste der Einzelteile



N636P223082

<p>1</p> 	<p>2</p> 	<p>3</p> 
<p>Oberes Kopfteil-1Stück</p>	<p>Beine des Kopfteils-2Stück</p>	<p>Seitengitte-2Stück</p>
<p>4</p> 	<p>5</p> 	<p>6</p> 
<p>Seitengitte-2Stück</p>	<p>Fußbrett-1Stück</p>	<p>Basis-Kopfteil-1Stück</p>
<p>7</p> 	<p>8</p> 	<p>9</p> 
<p>Krone-1Stück</p>	<p>Seitengitter Stützstange-4Stück</p>	<p>Querstrebe-1Stück</p>
<p>10</p> 	<p>11</p> 	<p>12</p> 
<p>Seitenschienen Stützbeine-2Stück</p>	<p>Lamelle-2Stück</p>	<p>Bettfüße-2Stück</p>

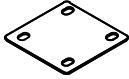
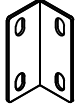
Hardwareliste

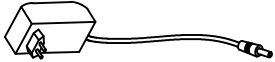
N636P223082



<p>A</p> 	<p>B</p>  <p>M8x16mm</p>	<p>C</p>  <p>M8x40mm</p>
<p>Inbusschlüssel(1Stück)</p>	<p>Bolzen(36Stück)</p>	<p>Bolzen(14Stück)</p>
<p>D</p>  <p>M8x45mm</p>	<p>E</p>  <p>M4x25mm</p>	<p>F</p>  <p>M3x16mm</p>
<p>Bolzen(4Stück)</p>	<p>Nägel(8Stück)</p>	<p>Nägel(28Stück)</p>
<p>G</p> 	<p>H</p> 	<p>I</p> 
<p>Schnalle(14Stück)</p>	<p>Vierloch-Eisenverbinde(3Stück)</p>	<p>"7"-Anschluss(4Stück)</p>
<p>J</p> 	<p>K</p> 	<p>L</p> 
<p>LED(1 Stück)</p>	<p>Farbregler(1 Stück)</p>	<p>LED-Adapte(1 Stück)</p>

<div style="border: 1px solid black; width: 20px; height: 20px; display: flex; align-items: center; justify-content: center; margin-bottom: 5px;">B</div> <div style="text-align: center;">  M8x16mm </div>	<div style="border: 1px solid black; width: 20px; height: 20px; display: flex; align-items: center; justify-content: center; margin-bottom: 5px;">C</div> <div style="text-align: center;">  M8x40mm </div>	<div style="border: 1px solid black; width: 20px; height: 20px; display: flex; align-items: center; justify-content: center; margin-bottom: 5px;">D</div> <div style="text-align: center;">  M8x45mm </div>
Bolzen(36Stück)	Bolzen(14Stück)	Bolzen(4Stück)

DE:Bitte beachten Sie, dass die Formen der Schrauben B und C und D ähnlich sind. Bitte installieren Sie entsprechend der Anleitung und unterscheiden Sie sie!

UK>Please note that the shapes of screws B and C and D are similar. Please install according to the instructions and distinguish them!

FR:Notez que les vis B et C et D ont des formes similaires. Veuillez les installer en suivant les instructions pour les séparer!

<div style="border: 1px solid black; width: 20px; height: 20px; display: flex; align-items: center; justify-content: center; margin-bottom: 5px;">E</div> <div style="text-align: center;">  M4x25mm </div>	<div style="border: 1px solid black; width: 20px; height: 20px; display: flex; align-items: center; justify-content: center; margin-bottom: 5px;">F</div> <div style="text-align: center;">  M3x16mm </div>
Nägel(8Stück)	Nägel(28Stück)

DE:Bitte beachten Sie, dass die Formen der Schrauben E und F ähnlich sind. Bitte installieren Sie entsprechend der Anleitung und unterscheiden Sie sie!

UK>Please note that the shapes of screws E and F are similar. Please install according to the instructions and distinguish them!

FR:Notez que les vis E et F ont des formes similaires. Veuillez les installer en suivant les instructions pour les séparer!

DE: Vor dem Einbau die Schrauben in die Löcher stecken und festziehen, aber nicht bis 100%, 70% bis 80% anziehen reicht aus. Schließlich, nachdem alle Schrauben installiert sind, ziehen Sie alle Schrauben auf 100%.

Wenn Sie auf diese Probleme stoßen, wie z. B. Fehlausrichtung der Löcher oder Unfähigkeit, bestimmte Teile zu installieren, überprüfen Sie bitte, ob die Schrauben korrekt verwendet werden und passen Sie die Dichtigkeit der Schrauben an.

UK: Before installation, insert the screws into the holes and tighten them, but do not tighten them to 100%, 70% to 80% is sufficient. Finally, after all screws are installed, tighten all screws to 100%.

If you encounter these issues, such as if the holes cannot be aligned or some parts cannot be installed, please check if the screws are used correctly and adjust the tightness of the screws.





FR: Insérer la vis dans le trou avant la fin de l'assemblage, serrer la vis, mais ne pas serrer à 100%, 70% ~ 80% est correct. Enfin, une fois que toutes les vis sont bien serrées, toutes les vis sont serrées à 100%.

Si vous rencontrez ces problèmes, par exemple si les trous ne sont pas alignés ou si certaines pièces ne peuvent pas être montées, vérifiez que les vis sont utilisées correctement et Ajustez leur serrage.

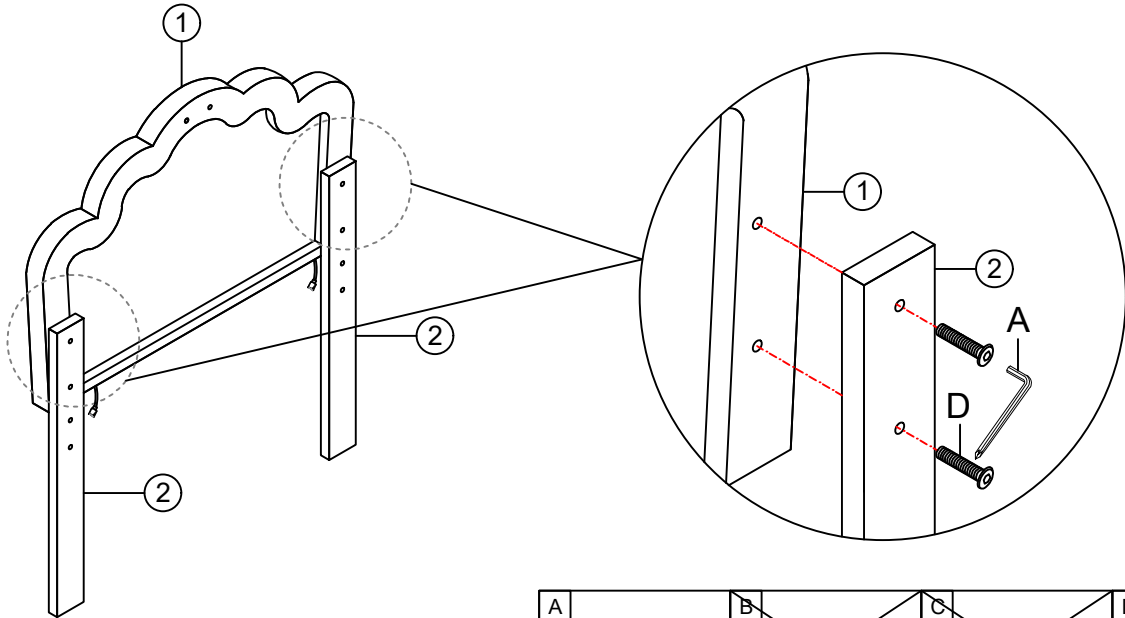
Hinweis: Wir empfehlen Ihnen, Ihr Bett im ebenen Boden aufzubauen.





Schritt 1:

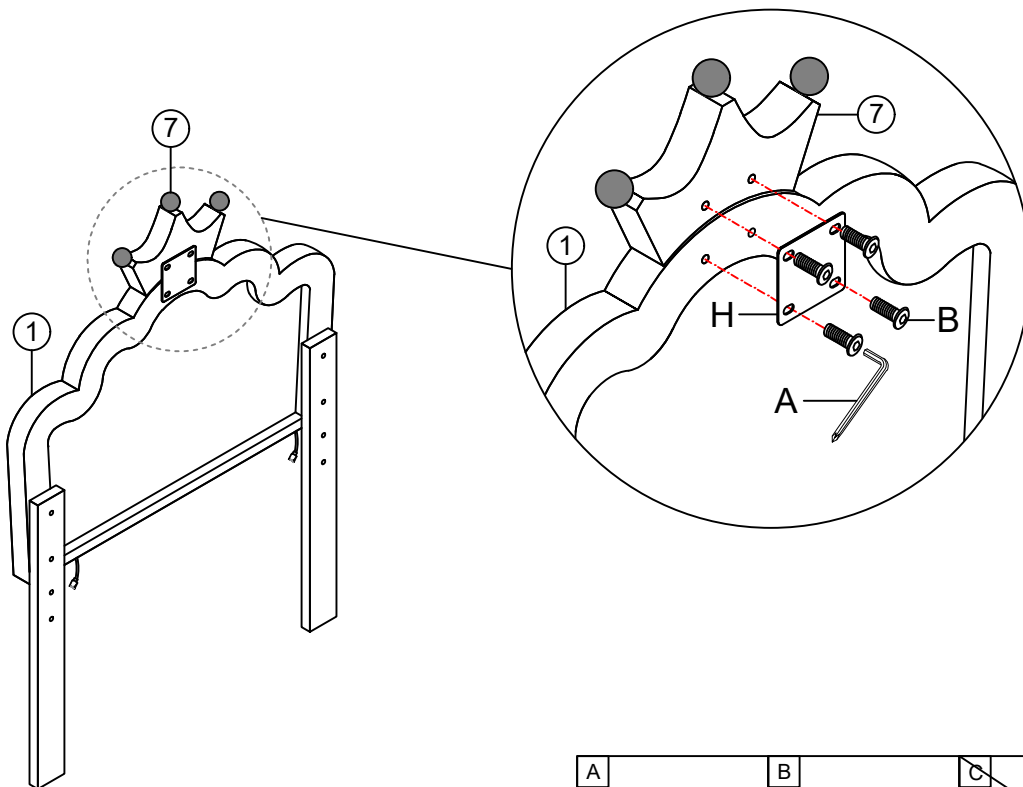

<p>A</p> 	<p>B</p>  <p>M8x16mm</p>	<p>C</p>  <p>M8x40mm</p>	<p>D</p>  <p>M8x45mm</p> <p>4Stück</p>
--	--	--	---

Schritt 2:



<p>A</p> 	<p>B</p>  <p>M8x16mm</p> <p>4Stück</p>	<p>C</p>  <p>M8x40mm</p>	<p>H</p>  <p>1Stück</p>
--	---	--	--

Schritt 3:

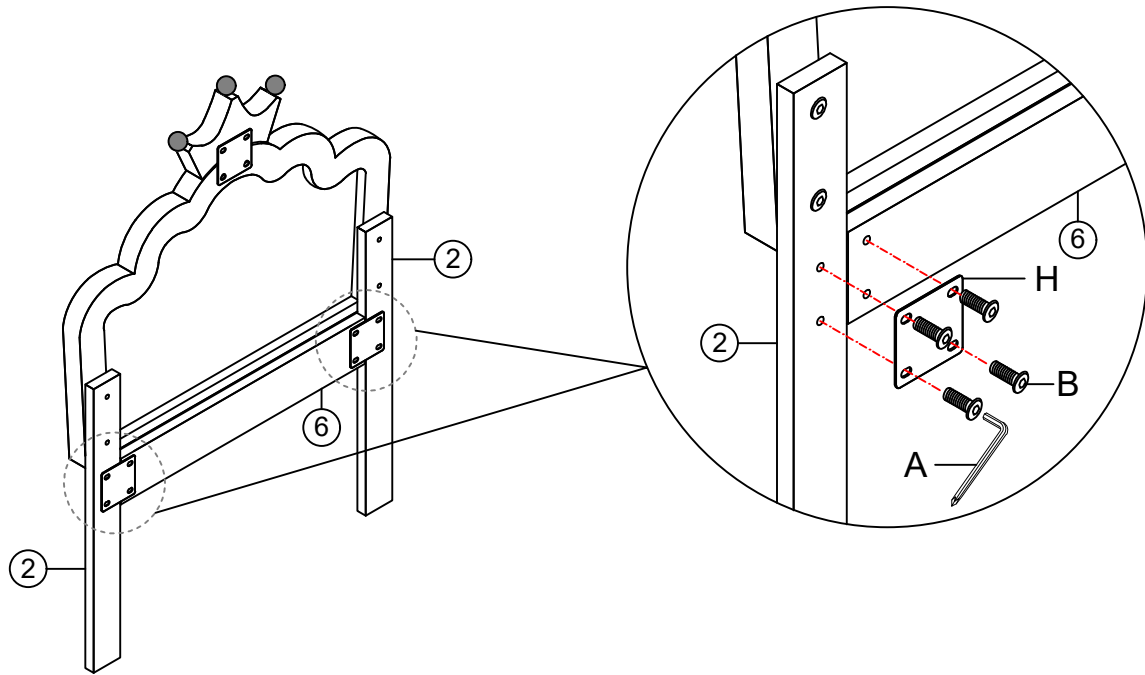

A 	B M8x16mm 8Stück	 C M8x40mm 	H 2Stück
--------------	-----------------------------------	---	------------------------

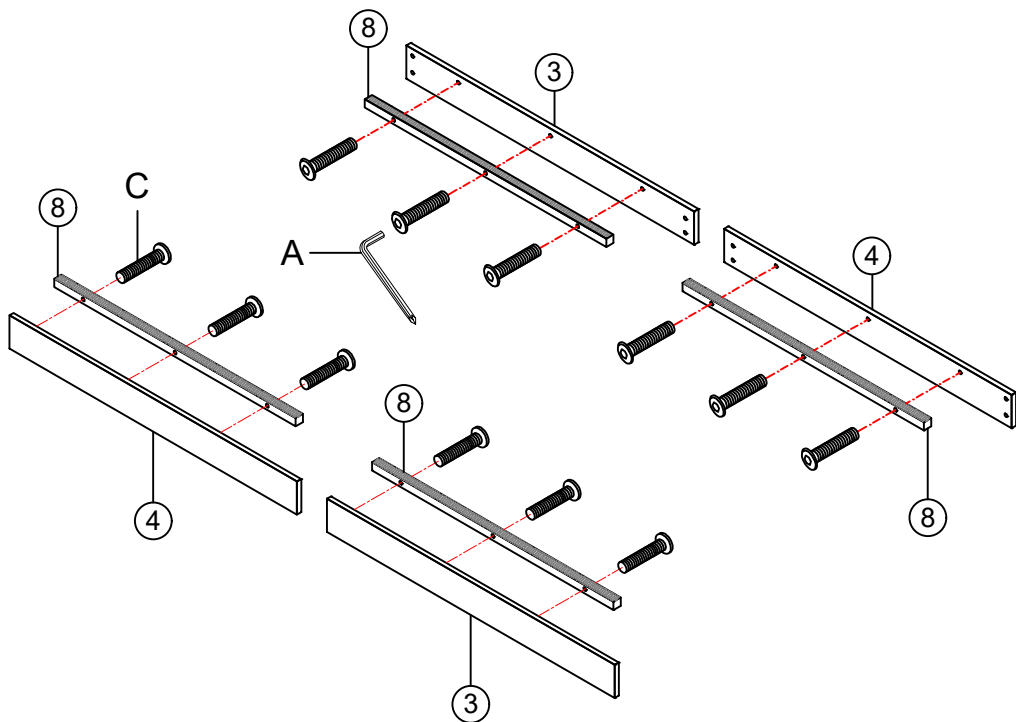

Schritt 4:



A 	 B M8x16mm 	C M8x40mm 12Stück
--------------	---	------------------------------------

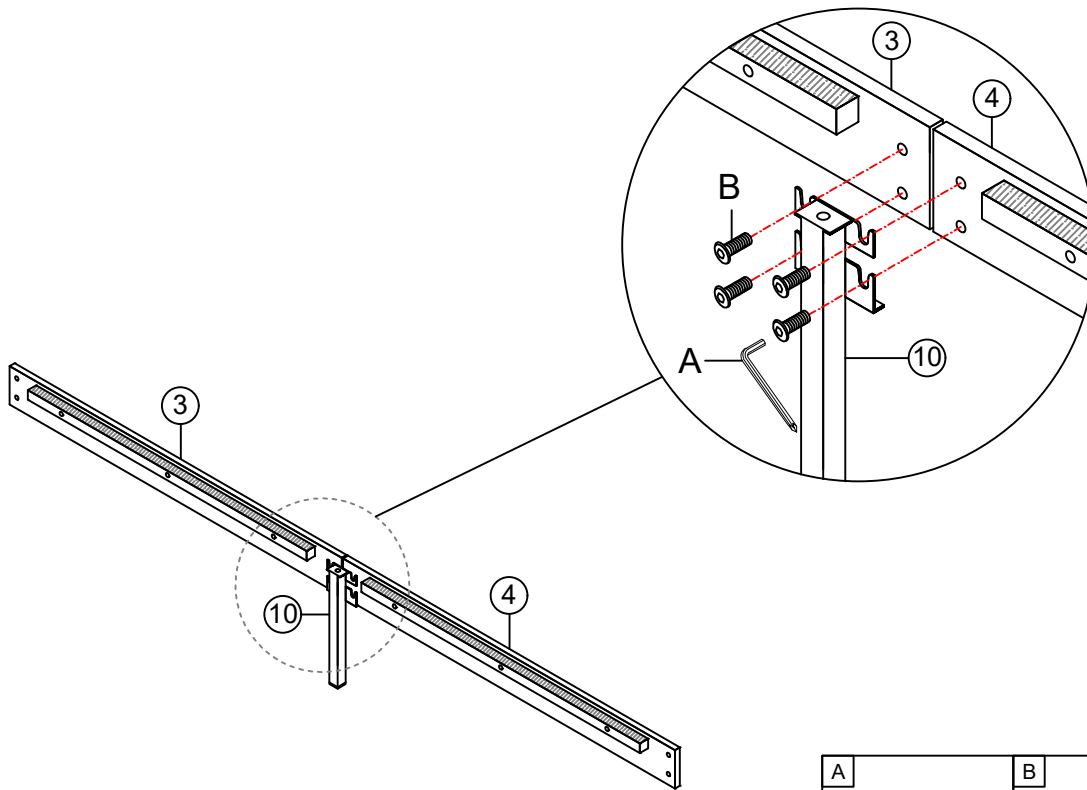



Schritt 5x2:

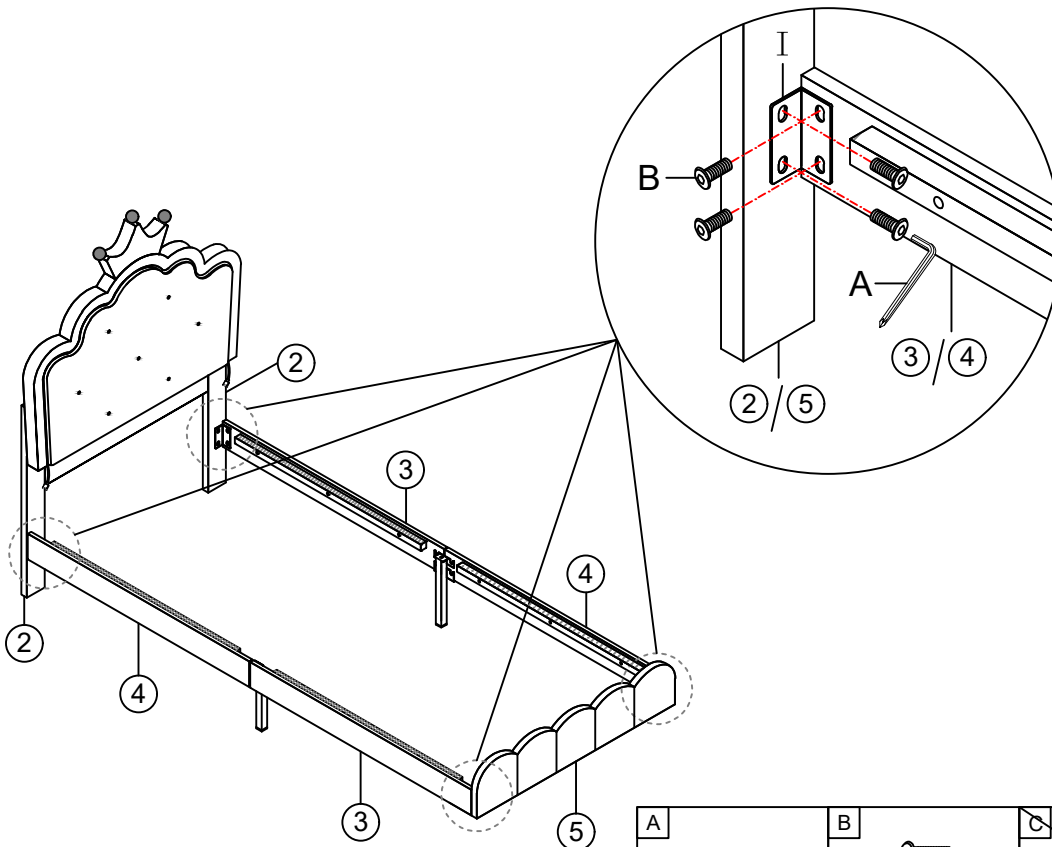

<p>A</p> 	<p>B</p>  <p>M8x16mm</p> <p>8Stück</p>	<p>C</p>  <p>M8x40mm</p>
---	---	---



Schritt 6:



<p>A</p> 	<p>B</p>  <p>M8x16mm</p> <p>16Stück</p>	<p>C</p>  <p>M8x40mm</p>	<p>I</p>  <p>4Stück</p>
--	--	---	--

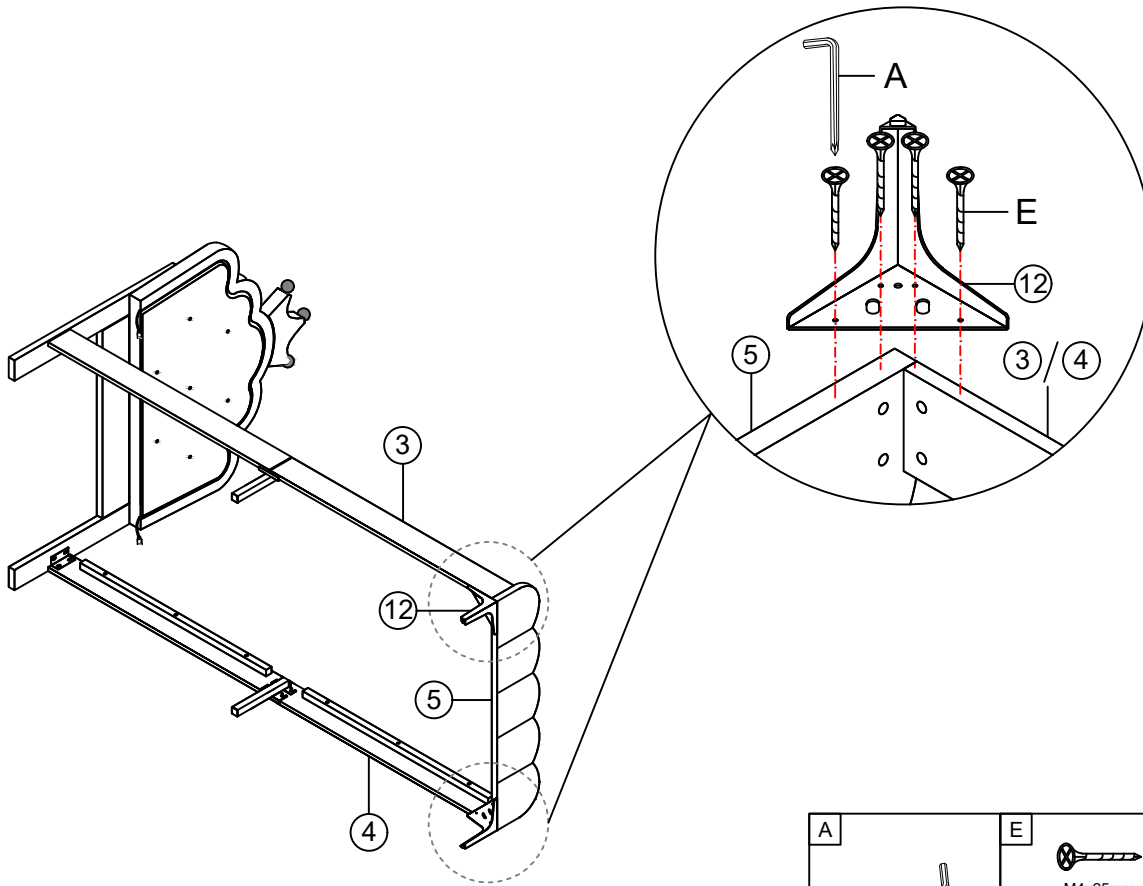

Schritt 7:



<p>A</p> 	<p>E</p>  <p>M4x25mm</p> <p>8Stück</p>	<p>F</p>  <p>M3x16mm</p>
---	---	---

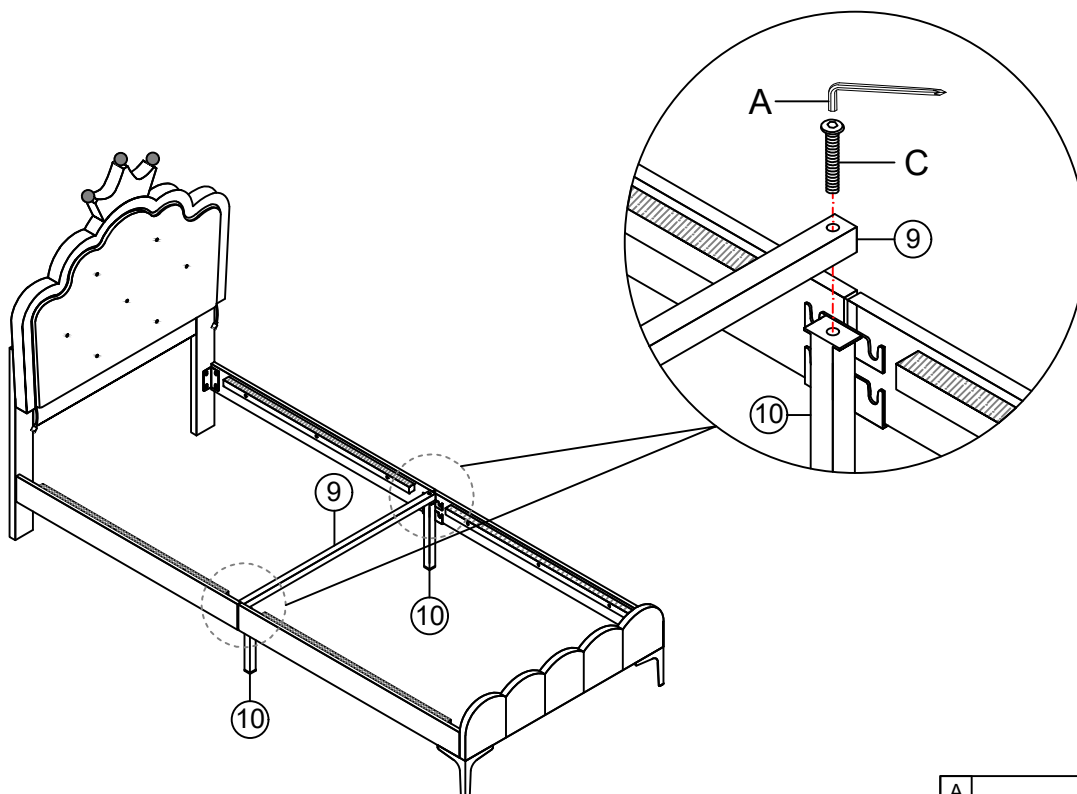



Schritt 8:

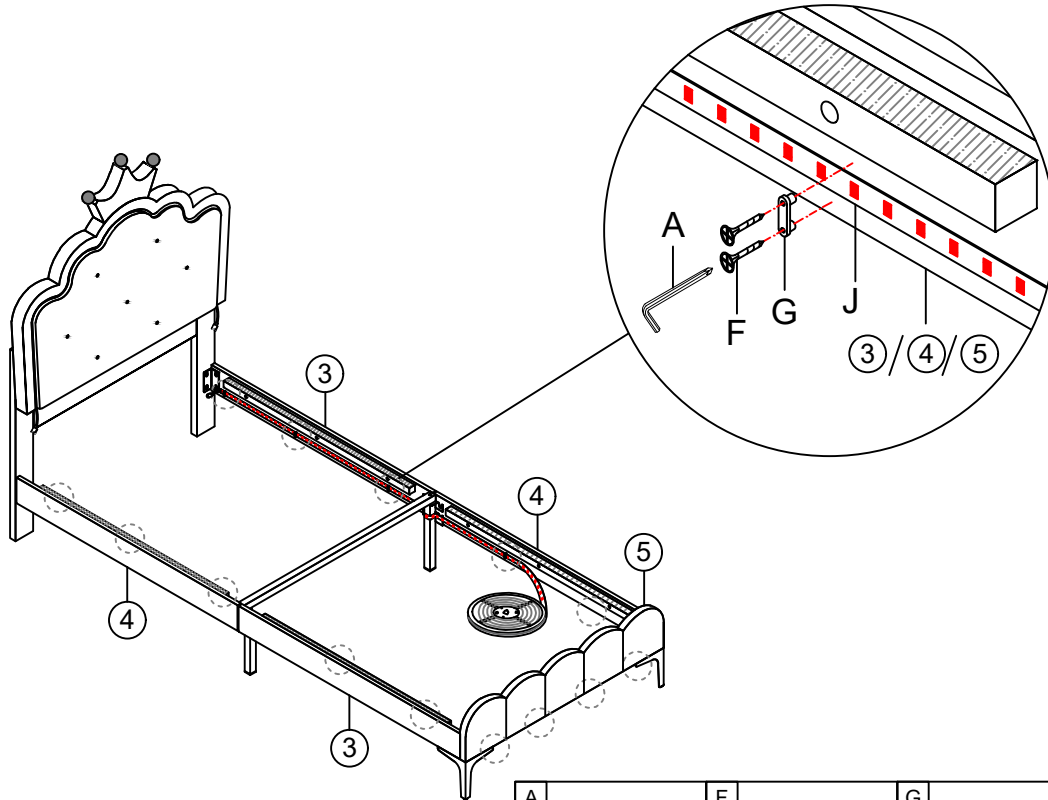

<p>A</p> 	<p>C</p>  <p>M8x40mm</p> <p>2Stück</p>
--	---

Schritt 9:



<p>A</p> 	<p>F</p>  <p>M3x16mm</p> <p>28Stück</p>	<p>G</p>  <p>14Stück</p>	<p>J</p>  <p>1Stück</p>
---	---	--	---

Schritt 10:

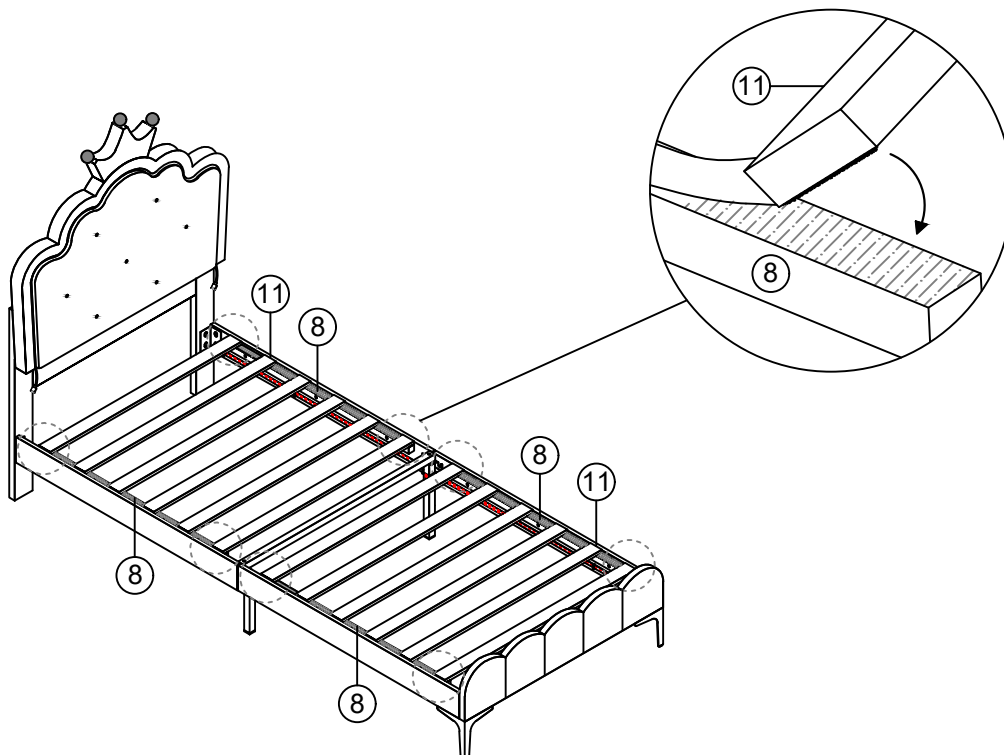

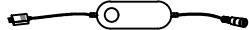
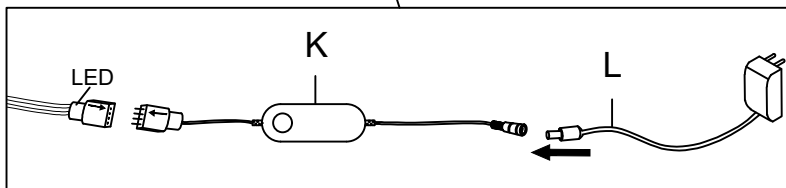
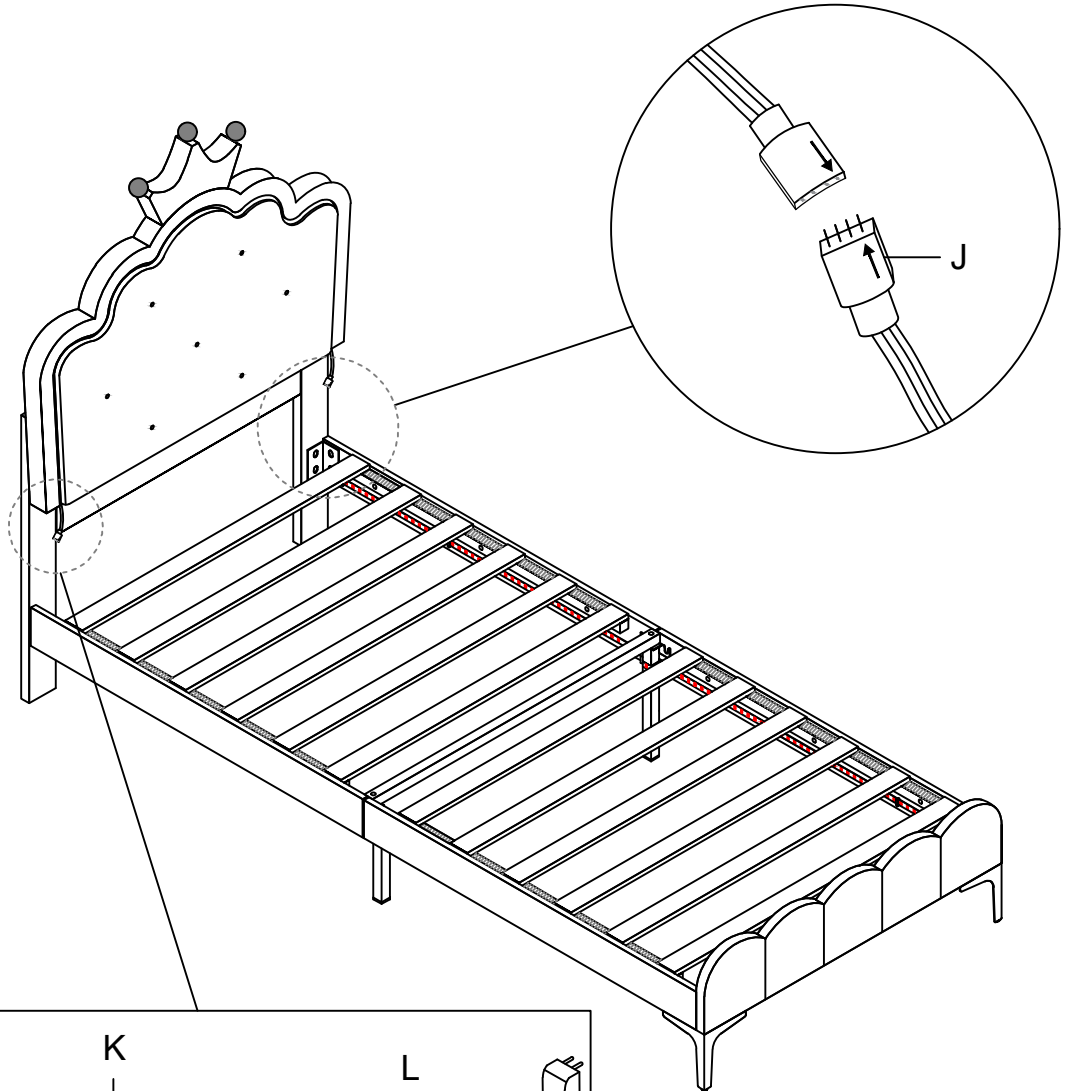

Schritt 11:



Reminder: Please control the color through the button switch on the controller or download the APP on your phone. You will see a detailed tutorial on how to control the color through the Bluetooth APP later.

Erinnerung: Bitte steuern Sie die Farbe über den Tastenschalter auf dem Controller oder laden Sie die APP auf Ihrem Mobiltelefon herunter. Sie werden später ein ausführliches Tutorial sehen, wie Sie die Farbe über die Bluetooth-App steuern können.

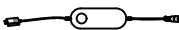
Rappel: S'il vous plaît contrôler la couleur via le commutateur de bouton sur le contrôleur ou télécharger l'application sur votre téléphone mobile. Vous verrez plus tard un tutoriel détaillé sur la façon de contrôler les couleurs via l'application Bluetooth.

K	L
	
1Stück	1Stück



LED Bluetooth controller Features

Caractéristiques du contrôleur Bluetooth LED

LED Bluetooth Controller Eigenschaften

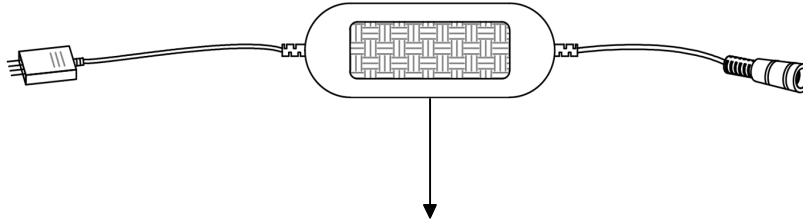

NOTICE:

Please scan the QR code to download the APP to control the color of the light strip.
Please refer to the following instructions for details.

Bitte scannen Sie den QR-Code, um die APP herunterzuladen, um die Farbe des Einzelheiten entnehmen Sie bitte der folgenden Anleitung.

Veillez scanner le code QR pour télécharger l'application pour contrôler la couleur de la bande lumineuse.

Veillez consulter les instructions ci-dessous pour plus de détails.

Click to show the lamp list

Cliquez pour afficher la liste des lumières
Klicken Sie, um die Liste der Lichter anzuzeigen

Switch the color wheel
Basculer la roue des couleurs
Farbrad wechseln

Display the RGB value Click to manual
Afficher les valeurs RVB Cliquez pour manuellement
RGB-Werte anzeigen Klicken Sie manuell

Adjustment view
Ajuster la vue
Ansicht anpassen

Click to shift the interface
Cliquez sur l'interface mobile Ansicht
Klicken Sie, um die Schnittstelle zu wechseln

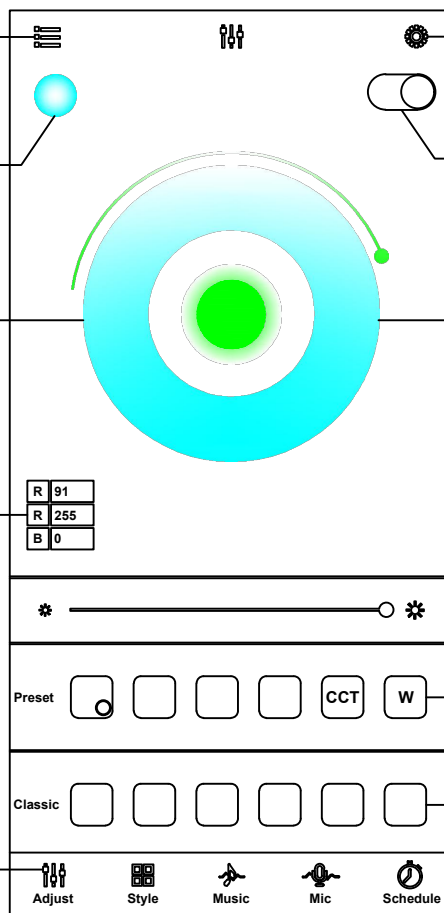

Click to display setting view

Cliquez pour afficher la vue des paramètres
Klicken Sie, um die Einstellungsansicht anzuzeigen

Lamp switch button
Bouton interrupteur lumière
Taste für Lichtschalter

Adjust the color
Ajuster la couleur
Farbe anpassen

Click square icon to
Cliquez sur l'icône du carré pour
Klicken Sie auf das quadratische Symbol, um

LED Bluetooth controller Features

Caractéristiques du contrôleur Bluetooth LED

LED Bluetooth Controller Eigenschaften

Product Features :

LED Bluetooth controller is directly via mobile phone control remote distance can reach 20m without the need to set up, easy to connect open the software within 5 seconds you can automatically connect the controller · Flow the rhythm of the music changes · Group control · Brightness, speed addition and subtraction · Maximum can be 10 meters RGB(W)strip · The software shows that the text is based on the language of the mobile phone set up automatic transformation of Chinese and English Animation Effect: · Colorful gradient ● All kinds of monochrome, double color gradient ● All kinds of monochrome, double color, colorfull flashing Follow the thym of the music chagnes
Product Paramters: · Bluetooth: BLE V4.2 · Input Voltage: 4.5~26V · Working Temp: -25~75
· Size: 43*22*11mm · Weight: 30g · Max Power: 144W(24V)

Caractéristiques du produit:

Le contrôleur Bluetooth LED est contrôlé directement via le téléphone portable La distance à distance peut atteindre 20m Aucun réglage requis, connexion facile Ouvrez le logiciel pour se connecter automatiquement au contrôleur dans les 5 secondes · Changement de rythme de la musique fluide · Contrôle de groupe · Luminosité, augmentation et diminution de vitesse · Jusqu'à 10 mètres barres RVB (W) · Le logiciel affiche le texte Convertir automatiquement les effets d'animation chinois et anglais selon les paramètres de langue du téléphone portable: · Dégradé coloré ● Divers dégradés monochrome et bicolore ● Divers clignotements monochrome, bicolore et colorés suivent le rythme de la musique chagnes Paramètres du produit: · Bluetooth: BLE V4.2 · Tension d'entrée: 4,5 ~ 26 V · Température de fonctionnement: -25 ~ 75 · Taille: 43 * 22 * 11 mm · Poids: 30 g · Puissance maximale: 144 W (24 V)

Produktmerkmale:

Der LED-Bluetooth-Controller wird direkt über das Mobiltelefon gesteuert. Die Fernentfernung kann bis zu 20 m erreichen. Keine Einstellung erforderlich, einfach zu verbinden. Öffnen Sie die Software, um den Controller automatisch innerhalb von 5 Sekunden zu verbinden · Rhythmusänderungen der fließenden Musik · Gruppensteuerung · Helligkeit, Geschwindigkeitserhöhung und -verringerung · Maximal 10 Meter RGB(W)-Streifen · Software zeigt Text, um den Animationseffekt zwischen Chinesisch und Englisch entsprechend den Spracheinstellungen des Mobiltelefons automatisch umzuwandeln: · Bunter Farbverlauf ● Verschiedene einfarbige und zweifarbige Farbverläufe ● Verschiedene einfarbige, zweifarbige und farbenfrohe Blinkungen folgen dem Rhythmus der Musik chagnes Produktparameter: · Bluetooth: BLE V4.2 · Eingangsspannung: 4,5 ~ 26 V · Betriebstemperatur: -25 ~ 75 · Größe: 43 * 22 * 11 mm · Gewicht: 30 g · Maximale Leistung: 144 W (24 V)

Verification of Compliance

Verification No.:	MK24030235P01-S01
Name and address of Applicant:	Shenzhen Hongzhengyu Technology Co., LTD Shenzhen baoan district rock street industrial science and technology industrial park of 2 Haitian lanyu 3 5 floor of A
Name and address of Manufacturer:	Shenzhen Hongzhengyu Technology Co., LTD Shenzhen baoan district rock street industrial science and technology industrial park of 2 Haitian lanyu 3 5 floor of A
Product name:	LED Lamp Strip
Rated:	DC5V, 2A, Max.10W HZY-2835-120D-12V, HZY-2835-30D-5V, HZY-2835-60D-5V, HZY-2835-120D-5V, HZY-2835-60D-12V, HZY-2835-60D-24V, HZY-2835-120D-24V, HZY-2835RGB-60D-5V, HZY-2835RGB-60D-12V, HZY-5050-30D-5V, HZY-5050-60D-5V, HZY-5050-30D-12V, HZY-5050-60D-12V, HZY-5050-60D-24V, HZY-5050RGB-30D-5V, HZY-5050RGB-60D-5V, HZY-5050RGB-30D-12V, HZY-5050RGB-60D-12V, HZY-5050RGB-60D-24V
Product model(s):	
Product trademark:	N/A

This verification confirms that the product meets the requirements of the following standard.
The conformity was demonstrated based on following standard(s) listed by European Commission as harmonized with LVD Directive 2014/35/EU.

EN IEC 60598-2-1:2021;
EN IEC 60598-1:2021+ A11:2022

The verification has been carried out in accordance with individual rules and conditions agreed with the applicant. Evaluation has been carried out in accordance with:

Test report(s) No.:	MK24030235P01-S01
Test conducted by:	TMC Testing Services (Shenzhen) Co., Ltd.
Verification issue date:	April 9, 2024

Notes:

This verification refers to the above mentioned product and its conformity in regards of above mentioned standard(s) was proven on test sample.

This verification does not imply meeting all essential requirements, assessment of the series-production or any other restricted Notified Bodies conformity assessment procedure appropriate for the product.

This verification holder shall use this verification in connection to Verification of Compliance and technical data relevant for the product the verification was issued.

TMC Testing Services (Shenzhen) Co., Ltd.

t:86-755-86642861 cert@tmc-lab.com www.tmc-lab.com

1/F., Block A, Xinshidai Gongrong Industrial Park, No. 2, Shihuan Road, Shilong Community, Shiyan Street, Baoan District, Shenzhen, China



Dawen Xu

Lab Director
Dawen Xu





CERTIFICATE OF CONFORMITY

Electromagnetic Compatibility (EMC) Directive 2014/30/EU

This Certificate of Conformity is hereby issued to the product designated below:

Certificate No. : 24EP01101E01
Report No. : EP2401101E01
Date Issue. : 2024-04-28
Applicant's name : Guangdong Sangu Technology Co., Ltd
Address : 402, Chuangye building, 8-28, Shaqi community Central Road, Xinqiao street, Bao'an District, Shenzhen.
Manufacturer's name : Guangdong Sangu Technology Co., Ltd
Address : 402, Chuangye building, 8-28, Shaqi community Central Road, Xinqiao street, Bao'an District, Shenzhen.
Product Description : POWER ADAPTER
Model(s)/Type References : SG-050yyyyz, GA-050yyyyz, GAT-050yyyyz, HZ-050yyyyz, SG-050yyyyAz, GA-050yyyyAz, GAT-050yyyyAz, HZ-050yyyyAz, SG-050yyyyAzC, GA-050yyyyAzC, GAT-050yyyyAzC, HZ-050yyyyAzC, SG-xxxyyyy12Az (xxx, yyyy, z are variables, appendix for details)
Parameters : See appendix for details
Standard(s) : EN 55032:2015+A11:2020+A1:2020
EN 55035:2017+A11:2020
EN IEC 61000-3-2:2019+A1:2021
EN 61000-3-3:2013+A1:2019+A2:2021

On the basis of the referenced test report(s), sample(s) tested of the above product have been found to comply with the standards harmonized with the directives listed on this verification at the time the tests were carried out. Other standards and Directives may be relevant to the product. This verification is part of the full test report(s) and should be read in conjunction with it(them).

Once compliance with all product relevant CE mark directives are verified, including any relevant e.g. risk assessment and production control, the manufacturer may indicate compliance by signing a Declaration of Conformity themselves and applying the mark to products identical to the tested sample(s).

Approved By

.....
Eric Liu
Director of engineering department



Dongguan Pubiao Testing Technology Co., Ltd

No. 3, 1/F., Building A, No.30, Minghua Road, Juzhou, Shijie, Dongguan, Guangdong, China

Tel: +86 769 81813516 E-mail: service@pubiaotest.com Web: www.pubiaotest.com

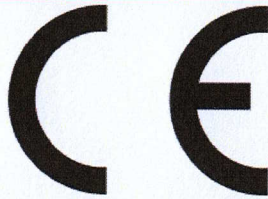

CERTIFICATE OF CONFORMITY

Electromagnetic Compatibility (EMC) Directive 2014/30/EU

Appendix of Certificate No.: 24EP01101E01

Table A: Definition of variables

Variable	Range of variable	Content
xxx	050-240	3 digits, indicates 10 times of output voltage in V and in step of 0.1V. eg. 050=5.0V, 240=24.0V.
yyyy	0100-2100	4 digits, indicates 1000 times of output current in A and in step of 0.01A. eg. 0100=0.1A, 2100=2.1A.
z	E, B	One capital letter representing the plug type for different countries. E represents European plug and Russian plug; B represents British plug.

Table B: Model list and input / output ratings

Model	Rated input	Rated output			Transformer
		Voltage range (VDC)	Current range (A)	Max. Power (W)	
SG-050yyyyz, GA-050yyyyz, GAT-050yyyyz, HZ-050yyyyz, SG-050yyyyAz, GA-050yyyyAz, GAT-050yyyyAz, HZ-050yyyyAz, SG-050yyyyAzC, GA-050yyyyAzC, GAT-050yyyyAzC, HZ-050yyyyAzC,	100-240V~, 50/60Hz, 0.3A Max.	5.0	0.1-2.0	10.0	EF1510
SG-xxxxyyy12Az	100-240V~, 50/60Hz, 0.6A Max.	5.0-5.5	0.10-2.1	11.55	EF1510-1
		5.6-12.0	0.10-2.0	12.00	
		12.1-24.0	0.10-1.0	12.00	





Dongguan Pubiao Testing Technology Co., Ltd

No. 3, 1/F., Building A, No.30, Minghua Road, Juzhou, Shijie, Dongguan, Guangdong, China

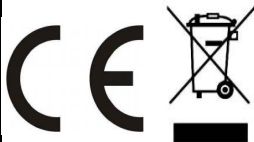
Tel: +86 769 81813516 E-mail: service@pubiaotest.com Web: www.pubiaotest.com

Importeur	Decobus Handel GmbH
Adresse	Innungsstraße 9, 21244 Buchholz, Deutschland
Email/URL	https://www.decobusgroup.de
Hersteller	Shenzhen Hongzhengyu Technology Co., LTD
Adresse	Shenzhen baoan district rock street industrial science and technology industrial park of 2 Haitian lanyu 3 5 floor of A
Email/URL	https://aoligd.1688.com/
Partienummer	LED light strip
Hergestellt in	China
	Decobus Handel GmbH Innungsstraße 9, 21244 Buchholz, Deutschland www.decobusgroup.de
	Product Name: LED light strip Model: HZY-5050RGB-30D-12V Rated voltage: DC12V Rated frequency: 50-60HZ Power: 5W/M

Importeur	Decobus Handel GmbH
Adresse	Innungsstraße 9, 21244 Buchholz, Deutschland
Email/URL	https://www.decobusgroup.de
Hersteller	Guangdong sangu Technology Co., LTD
Adresse	402 Chuangye building, 8-28, Shaqi community Central Road, Xingqiao street Bao'an District, Shenzhen
Email/URL	https://aoligd.1688.com/
Partienummer	Power Adapter
Hergestellt in	China
	Decobus Handel GmbH Innungsstraße 9, 21244 Buchholz, Deutschland www.decobusgroup.de
	Product Name: Power Adapter Model: SG 120200024AE Rated voltage: DC12V Rated frequency: 50-60HZ Power: 24W



FR

Cet appareil,
ses accessoires,
cordons et batteries
se recyclent

À DÉPOSER
EN MAGASIN



OU

À DÉPOSER
EN DÉCHÈTERIE



Points de collecte sur www.quefairedemesdechets.fr
Privilégiez la réparation ou le don de votre appareil !