

INSTRUCTION

ANLEITUNG

MANUEL D'UTILISATION



SKU:N621P306852/N621P306853

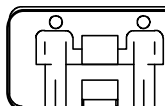
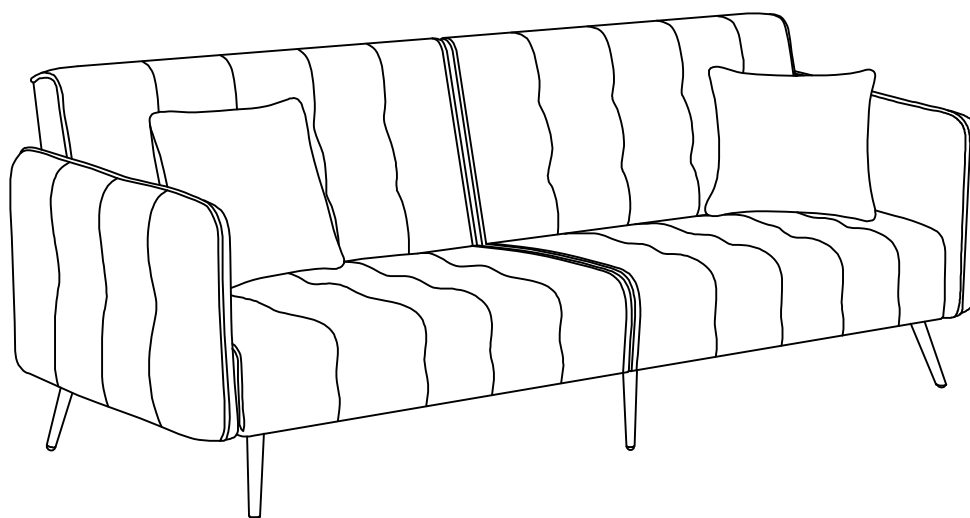

TEAM ASSEMBLY TEAMVERSAMMLUNG
RECOMMENDED EMPFOHLEN

Sofa

Importeur	Decobus Handel GmbH
Adresse	Innungsstraße 9, 21244 Buchholz, Deutschland
URL	https://www.decobusgroup.de
Hersteller	NINE U (HK) LIMITED
Adresse	FLAT 404, 4/F GOLDEN GATE COMM BLDG 136-138 AUSTIN RD, TST HONG KONG
Email/URL	489617350@qq.com
P.O.Nr	N621P306852/N621P306853
	Decobus Handel GmbH Innungsstraße 9, 21244 Buchholz, Deutschland https://www.decobusgroup.de



[DE]

Warnung: Lesen Sie die Anleitung vor dem Zusammenbau bitte vollständig durch. Überprüfen Sie, ob Sie alle auf den Seiten aufgeführten Komponenten und Werkzeuge haben.

Warnung: Überprüfen Sie regelmäßig alle Beschläge und Befestigungen, um sicherzustellen, dass sie sicher sind und um Unfälle zu vermeiden.

Warnung: Stellen Sie Möbel nicht in die Nähe von Feuerquellen oder heißen Gegenständen, um Brandgefahr zu vermeiden.

Warnung: Erlauben Sie Kindern nicht, auf die Möbel zu klettern, da dies zum Umkippen und zu schweren Verletzungen führen kann. Bauen Sie die Möbel außerhalb der Reichweite von Kindern zusammen.

[EN]

Warning: Please read instructions fully before starting assembly. Check you have all the components and tools listed on pages.

Warning: Regularly check all fittings and fastenings to ensure they are secure and to prevent accidents.

Warning: Do not place furniture close to fire sources or high-temperature objects to avoid the risk of fire.

Warning: Do not allow children to climb on the furniture as this may result in tipping and serious personal injury. Assemble the furniture away from the reach of children.

[FR]

Avertissement : Veuillez lire entièrement les instructions avant de commencer l'assemblage. Vérifiez que vous disposez de tous les composants et outils répertoriés sur les pages.

Avertissement : Vérifiez régulièrement tous les accessoires et fixations pour vous assurer qu'ils sont bien fixés et pour éviter les accidents.

Avertissement : Ne placez pas les meubles à proximité de sources de feu ou d'objets à haute température pour éviter tout risque d'incendie.

Avertissement : Ne laissez pas les enfants grimper sur les meubles car cela pourrait entraîner un basculement et des blessures graves. Assemblez les meubles hors de portée des enfants.

[IT]

Attenzione: leggere attentamente le istruzioni prima di iniziare il montaggio. Verificare di avere tutti i componenti e gli utensili elencati nelle pagine.

Attenzione: controllare regolarmente tutti i raccordi e gli elementi di fissaggio per assicurarsi che siano sicuri e prevenire incidenti.

Attenzione: non posizionare i mobili vicino a fonti di fuoco o oggetti ad alta temperatura per evitare il rischio di incendio.

Attenzione: non consentire ai bambini di arrampicarsi sui mobili poiché ciò potrebbe causare ribaltamenti e gravi lesioni personali. Montare i mobili lontano dalla portata dei bambini.

[ES]

Advertencia: Lea las instrucciones completamente antes de comenzar el montaje. Compruebe que tiene todos los componentes y herramientas que se enumeran en las páginas.







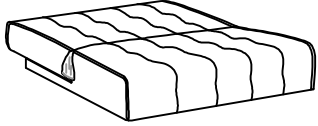
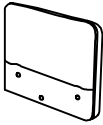

Advertencia: Compruebe periódicamente todos los accesorios y sujeciones para asegurarse de que estén seguros y evitar accidentes.

Advertencia: No coloque los muebles cerca de fuentes de fuego u objetos a alta temperatura para evitar el riesgo de incendio.



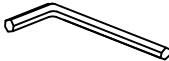
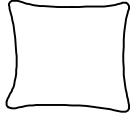





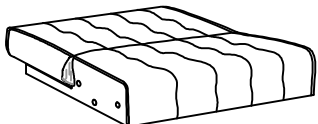
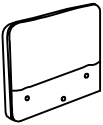

Advertencia: No permita que los niños se suban a los muebles, ya que esto puede provocar que vuelquen y lesiones personales graves. Monte los muebles fuera del alcance de los niños.

PARTS LIST
LISTE DER EINZEL TEILE
LISTE DES PIÈCES

N621P306852

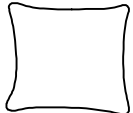
<p>A X1</p>  <p>Right Seater Rechter Sitz Place droite</p>	<p>C X1</p>  <p>Right Arm Rechter Arm Bras droit</p>	<p>E X2</p>  <p>Legs Beine jambes</p>	<p>F X1</p>  <p>Middle leg Mittelbein Jambe moyenne</p>
<p>G X6</p>  <p>Bolt Schrauben boulon</p>	<p>H X6</p>  <p>Gasket Dichtung Joint d' étanchéité</p>	<p>I X1</p>  <p>Allen Key Inbusschlüssel Clé d' allen</p>	<p>J X1</p>  <p>Pillow Kissen oreiller</p>
<p>K X3</p>  <p>Bolt for armrest connection Vis de connexion pour accoudoirs Verbindungsschraube für Armlehne</p>	<p>L X3</p>  <p>Nut Les écrous Nuss</p>	<p>M X3</p>  <p>Gasket Dichtung Joint d' étanchéité</p>	<p>N X1</p>  <p>Open-end Wrench Schraubenschlüssel mit offenem Ende Clé ouverte</p>

N621P306853

<p>B X1</p>  <p>Left Seater Linker Sitz Place gauche</p>	<p>D X1</p>  <p>Left Arm Linker Arm Bras gauche</p>	<p>E X2</p>  <p>Legs Beine jambes</p>	<p>F X1</p>  <p>Middle leg Mittelbein Jambe moyenne</p>
<p>G X6</p>  <p>Bolt Schrauben boulon</p>	<p>H X6</p>  <p>Gasket Dichtung Joint d' étanchéité</p>	<p>I X1</p>  <p>Allen Key Inbusschlüssel Clé d' allen</p>	<p>J X1</p>  <p>Pillow Kissen oreiller</p>
<p>K X3</p>  <p>Bolt for armrest connection Vis de connexion pour accoudoirs Verbindungsschraube für Armlehne</p>	<p>L X3</p>  <p>Nut Les écrous Nuss</p>	<p>M X3</p>  <p>Gasket Dichtung Joint d' étanchéité</p>	<p>N X1</p>  <p>Open-end Wrench Schraubenschlüssel mit offenem Ende Clé ouverte</p>

Sofa Gesamtmontagezeichnung
 Sofa Overall Assembly Drawing
 Dessin d'assemblage global du canapé

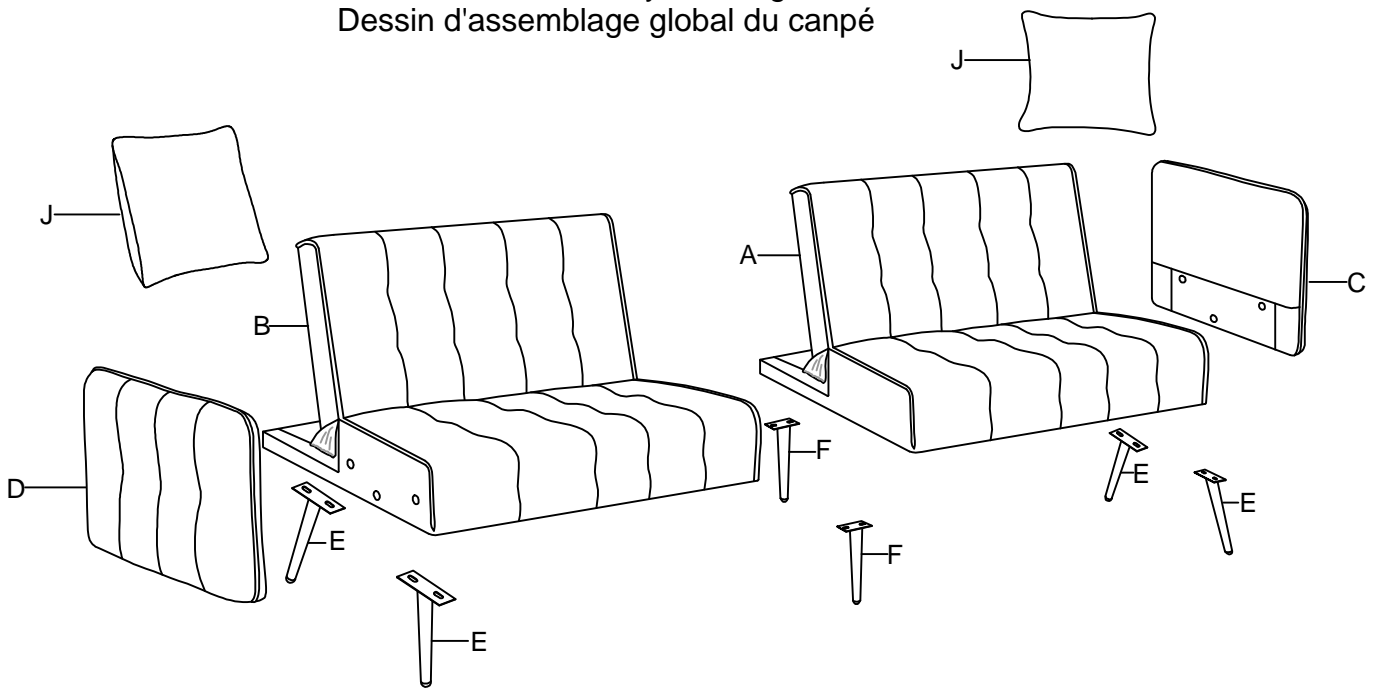

Step1 / Schritt1/Etape1

Please remove the armrests from the bottom of the sofa frame.

Bitte entfernen Sie die Armlehnen von Die Unterseite des Sofarahmens.

Veillez retirer les accoudoirs du bas de Le cadre du canapé.

Notez la ligne rouge. Après avoir retiré l'accoudoir, vous pouvez l'arracher
 Bitte achten Sie auf die rote Linie. Nach dem Herausnehmen der Armlehne können Sie sie abreißen

Please pay attention to the red line. After taking out the armrest, you can tear it off

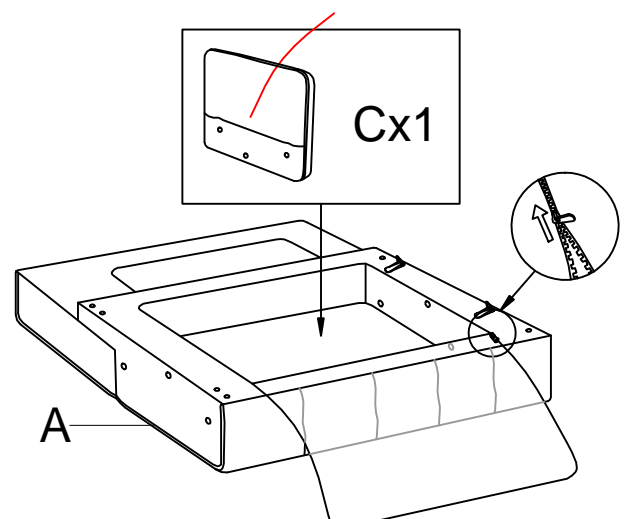
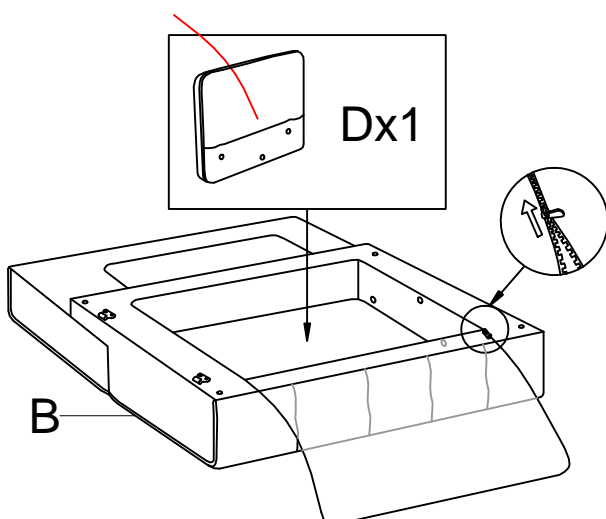

Step2 / Schritt2/Etape2

Please remove the accessory and
Pillows box from component
Lease entfernen Sie die und kissen
Zubehörbox von

Bail enlever l'accessoire et
Pillowsbox de composant

Notez la ligne rouge. Après avoir retiré l'accoudoir, vous pouvez l'arracher
Bitte achten Sie auf die rote Linie. Nach dem Herausnehmen der Armlehne
können Sie sie abreißen

Please pay attention to the red line. After taking out the armrest, you can tear it off

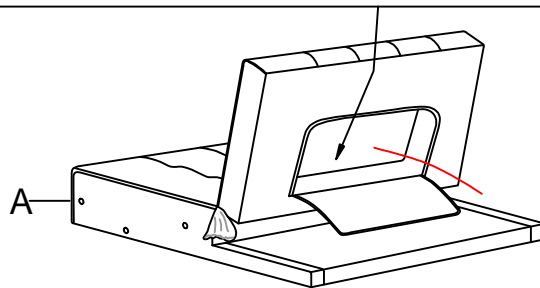
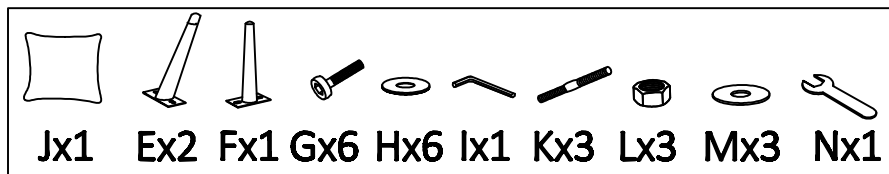

Notez la ligne rouge. Après avoir retiré l'accoudoir, vous pouvez l'arracher
Bitte achten Sie auf die rote Linie. Nach dem Herausnehmen der Armlehne
können Sie sie abreißen



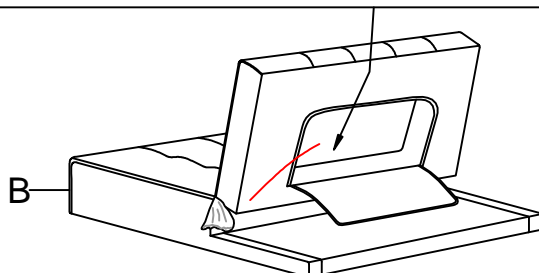
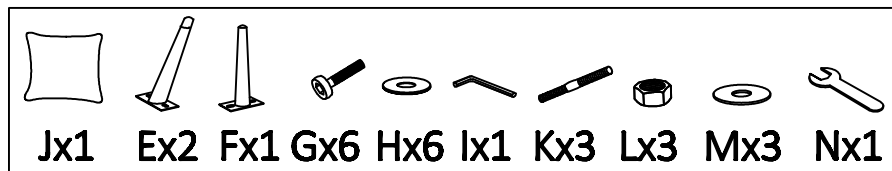

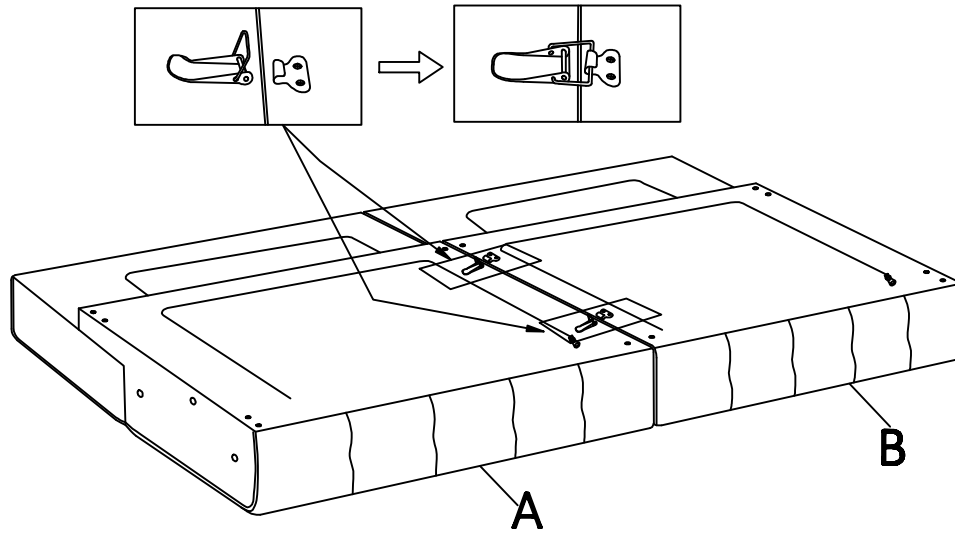

Please pay attention to the red line. After taking out the armrest, you can tear it off



Step3 / Schirrt3 / Etape3



Step4 / Schirrt4 / Etape4

- 
Ax1
- 
Bx1
- 
Ex4
- 
Fx2
- 
Gx6
- 
Hx6
- 
Ix1

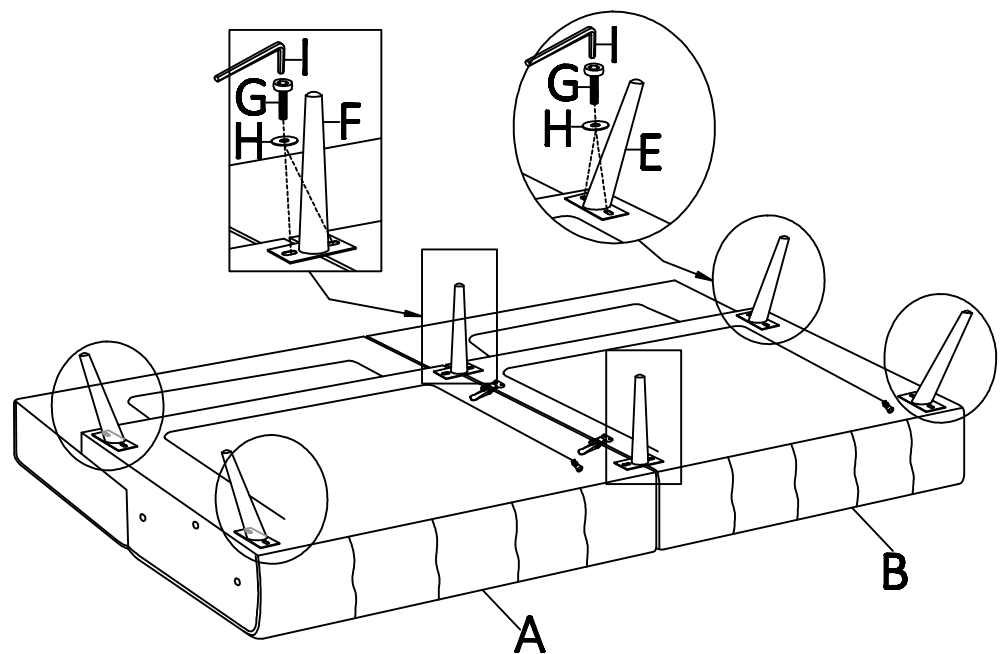

Step5 / Schirrt5 / Etape5

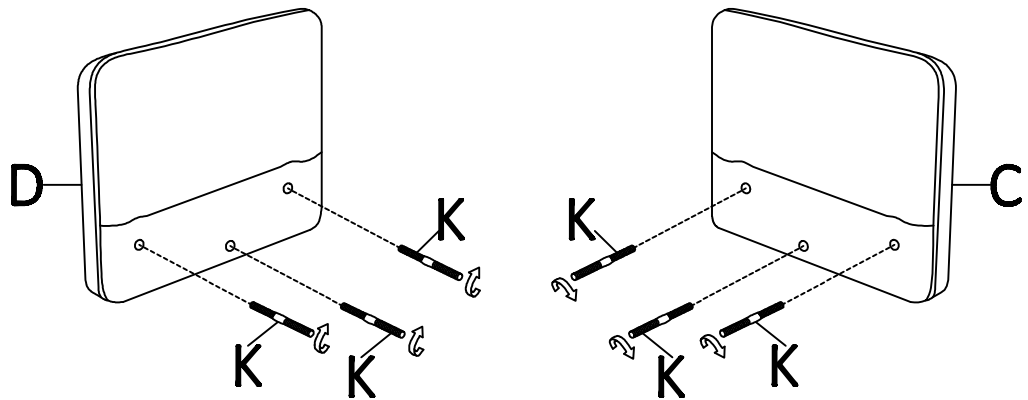
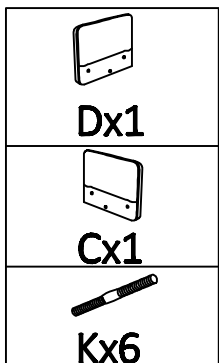

Step6 / Schirrt6 / Etape6

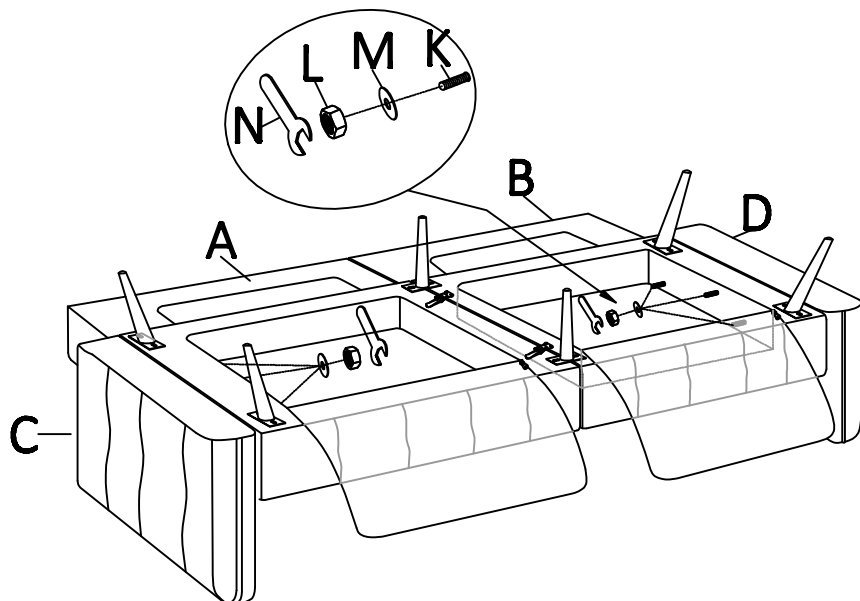
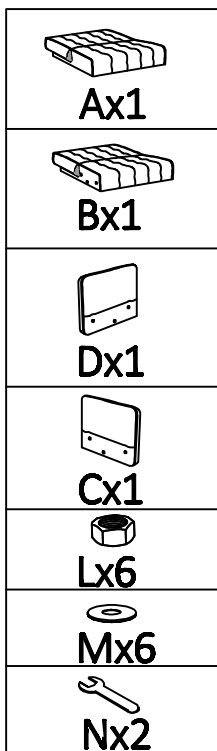

Step7 / Schritt7 / Etape7

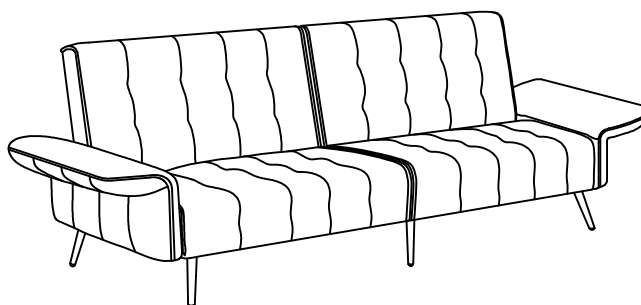
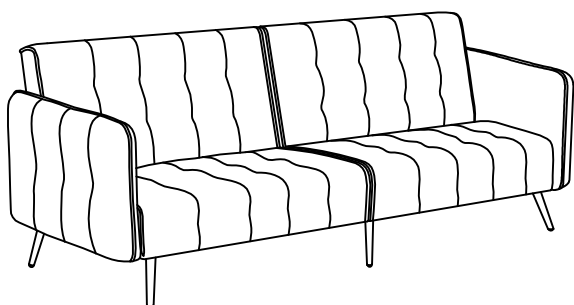
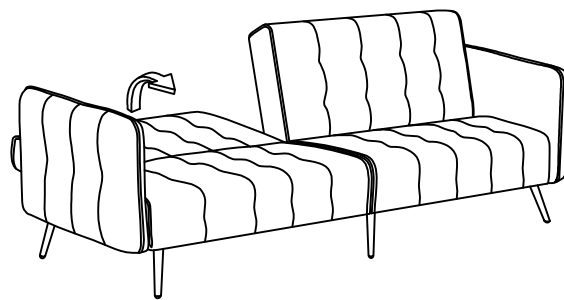
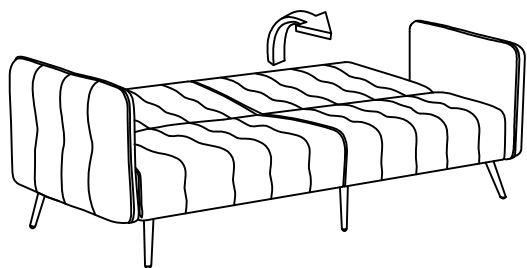

Step8 / Schritt8 / Etape8

