

# Installation sanleitung Installation instruction Instruction d'installation

SKU: N636P288479  
N636P288480

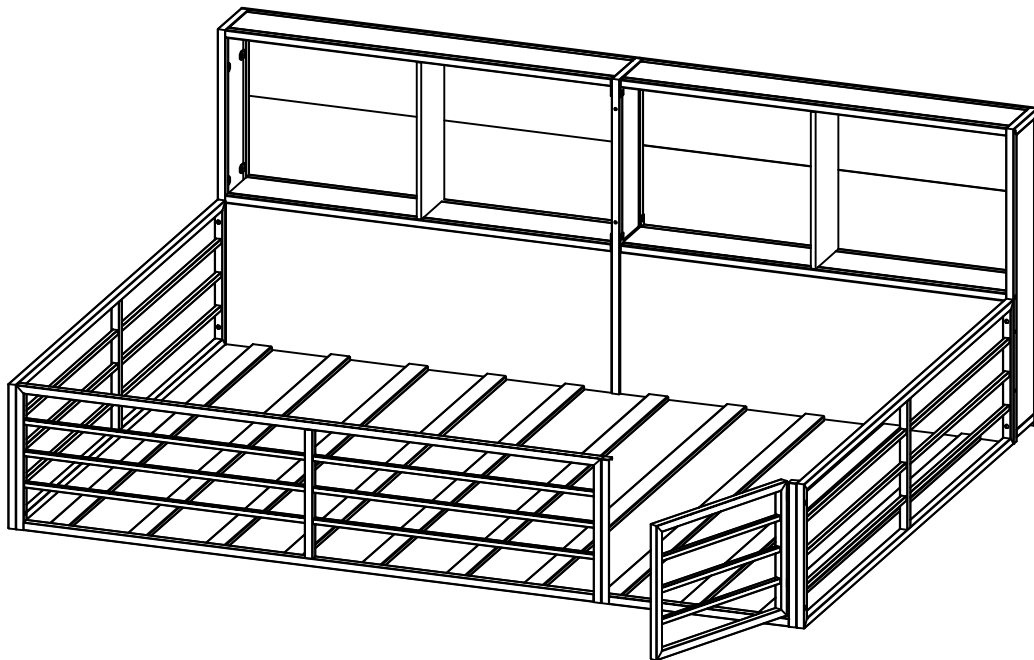

**Unser Produkt wird Ihnen in 2 Paketen geliefert. Die Lieferzeiten dieser 2 Paketekönnen abweichen.bitte haben Sie etwas Geduld und vielen Dank für Ihr Verständnis**

**Our product will be delivered to you in 2 packages. The delivery times of these2 packages may differ,please be patient and thank you for your understanding**

**Notre produit vous sera livre en 2 colis. Les delais de livraison de ces 2 colispeuvent differer,soyez patient et merci pour votre compréhension.**



FR

Pensez à  
donner ou recycler.



Association



Magasin



Déchèterie

<https://quefairedemesdechets.fr>

## English

### IMPORTANT ! KEEP FOR FUTURE REFERENCE : READ CAREFULLY

- To be assembled by an adult. Assembly must be checked by an adult before use
- WARNING ! Keep all screws, small parts and plastic bags out of the reach of children
- Properly identify all parts before assembling
- Never use your item if any of its parts are broken or missing
- Should any problems arise, please contact our After Sales Service
- Manufacturer's instructions shall be followed at all times
- Care: Clean with a soft, dry cloth. In case of larger stains, carefully rub with a slightly damp, non-abrasive sponge
- Avoid the risk of fire by not placing furniture near sources of ignition or hot items
- Do not jump on the bed

## Deutsch

### WICHTIG ! ZUM SPÄTEREN NACHSCHLAGEN AUFBEWAHREN: SORGFÄLTIG LESEN

- Muss von einem Erwachsenen zusammengebaut werden. Der Zusammenbau muss vor dem Gebrauch von einem Erwachsenen überprüft werden
- WARNUNG! Bewahren Sie alle Schrauben, Kleinteile und Plastikbeutel außerhalb der Reichweite von Kindern auf
- Kennzeichnen Sie vor dem Zusammenbau alle Teile richtig
- Benutzen Sie Ihren Artikel niemals, wenn Teile gebrochen sind oder fehlen
- Sollten Probleme auftreten, wenden Sie sich bitte an unseren Kundendienst
- Die Anweisungen des Herstellers sind stets zu befolgen
- Pflege: Mit einem weichen, trockenen Tuch reinigen. Bei größeren Flecken vorsichtig mit einem leicht feuchten, nicht scheuernden Schwamm abreiben. nicht scheuernden Schwamm
- Vermeiden Sie die Gefahr eines Brandes, indem Sie die Möbel nicht in der Nähe von Zündquellen oder heißen Gegenständen aufstellen
- Nicht auf das Bett springen

## Français

### IMPORTANT ! CONSERVER POUR RÉFÉRENCE ULTÉRIEURE : LIRE ATTENTIVEMENT

- Le montage doit être effectué par un adulte. Le montage doit être vérifié par un adulte avant Utilisation
- ATTENTION ! Tenir les vis, les petites pièces et les sachets en plastique hors de portée des enfants
- Identifiez correctement toutes les pièces avant de les assembler
- N'utilisez jamais votre article si l'une de ses pièces est cassée ou manquante
- En cas de problème, veuillez contacter notre service après-vente
- Les instructions du fabricant doivent être respectées à tout moment
- Entretien : nettoyer avec un chiffon doux et sec. En cas de taches plus importantes, frotter soigneusement avec une éponge non abrasive légèrement humide. légèrement humide et non Abrasive
- Évitez les risques d'incendie en ne plaçant pas les meubles à proximité de sources d'inflammation ou d'objets chauds
- Ne pas sauter sur le lit

## Italiano

### IMPORTANTE! CONSERVARE PER RIFERIMENTO FUTURO: LEGGERE ATTENTAMENTE

- Deve essere assemblato da un adulto. L'assemblaggio deve essere controllato da un adulto prima dell'uso
- **ATTENZIONE!** Tenere tutte le viti, le piccole parti e i sacchetti di plastica fuori dalla portata dei bambini
- Identificare correttamente tutte le parti prima dell'assemblaggio
- Non utilizzare mai l'articolo se alcune parti sono rotte o mancanti
- In caso di problemi, si prega di contattare il nostro Servizio Post Vendita
- Le istruzioni del produttore devono essere sempre seguite
- Cura: Pulire con un panno morbido e asciutto. In caso di macchie più estese, strofinare accuratamente con una spugna leggermente umida e nonspugna leggermente umida e non abrasiva
- Evitare il rischio di incendio, non collocando i mobili vicino a fonti di accensione o a oggetti caldi
- Non saltare sul letto

## Español

### ¡ IMPORTANTE ! CONSERVELO PARA FUTURAS CONSULTAS: LEA ATENTAMENTE

- Debe ser montado por un adulto. El montaje debe ser comprobado por un adulto antes del uso
- ADVERTENCIA Mantenga todos los tornillos, piezas pequeñas y bolsas de plástico fuera del alcance de los niños.
- Identifique correctamente todas las piezas antes de montarlas
  - Nunca utilice su artículo si alguna de sus piezas está rota o falta
  - Si surge algún problema, póngase en contacto con nuestro Servicio Postventa
  - Las instrucciones del fabricante deben seguirse en todo momento
  - Cuidado: Limpiar con un paño suave y seco. En caso de manchas más grandes, frote cuidadosamente con una esponja no abrasiva ligeramente humedecida.
  - Evite el riesgo de incendio no colocando los muebles cerca de fuentes de ignición u objetos calientes.
  - No saltar sobre la cama.

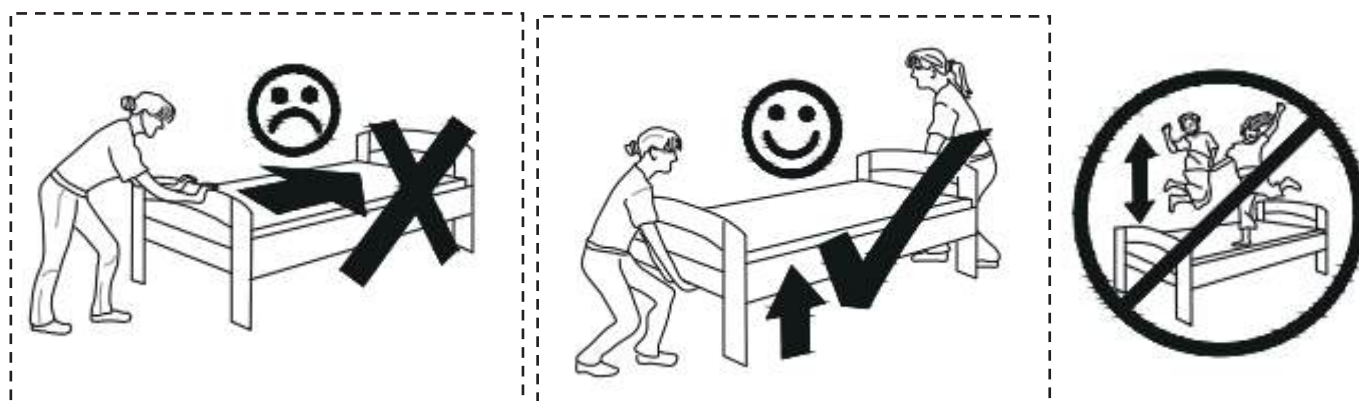

**DE:** Vor dem Einbau die Schrauben in die Löcher stecken und festziehen, aber nicht bis 100%, 70% bis 80% anziehen reicht aus. Schließlich, nachdem alle Schrauben installiert sind, ziehen Sie alle Schrauben auf 100%. Wenn Sie auf diese Probleme stoßen, wie z. B. Fehlausrichtung der Löcher oder Unfähigkeit, bestimmte Teile zu installieren, überprüfen Sie bitte, ob die Schrauben korrekt verwendet werden und passen Sie die Dichtigkeit der Schrauben an.

Personen werden empfohlen, zu beenden.

**UK:** Before installation, insert the screws into the holes and tighten them, but do not tighten them to 100%, 70% to 80% is sufficient. Finally, after all screws are installed, tighten all screws to 100%. If you encounter these issues, such as if the holes cannot be aligned or some parts cannot be installed, please check if the screws are used correctly and adjust the tightness of the screws.

It is recommended that two people install it.

**FR:** Insérer la vis dans le trou avant la fin de l'assemblage, serrer la vis, mais ne pas serrer à 100%, 70% ~ 80% est correct. Enfin, une fois que toutes les vis sont bien serrées, toutes les vis sont serrées à 100%.





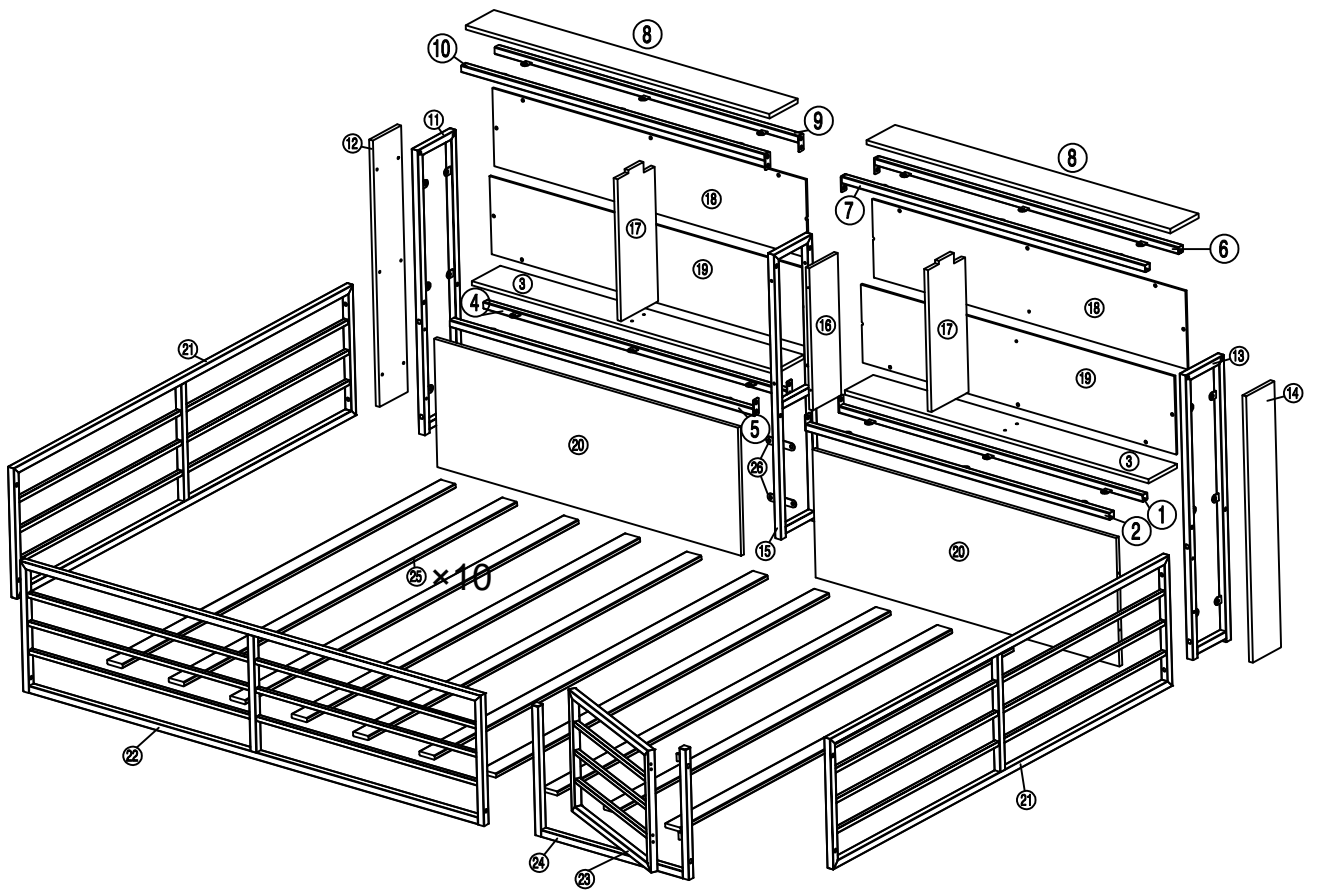

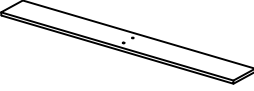

Si vous rencontrez ces problèmes, par exemple si les trous ne sont pas alignés ou si certaines pièces ne peuvent pas être montées, vérifiez que les vis sont utilisées correctement et Ajustez leur serrage.

Il est conseillé que deux personnes procèdent à l'installation ensemble.







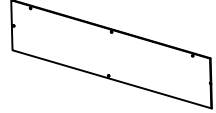
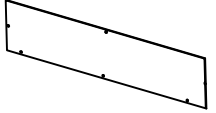
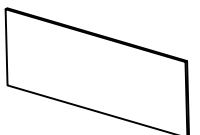
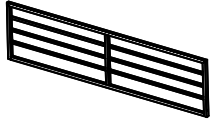
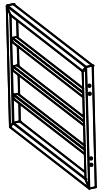
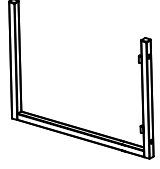

# Parts list /Teileliste /Liste des pièces

N636P288479

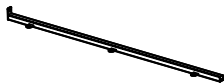
<p>③</p>  <p>2 PCS</p>	<p>⑧</p>  <p>2 PCS</p>	<p>⑪</p>  <p>1 PC</p>	<p>⑫</p>  <p>1 PC</p>
<p>⑬</p>  <p>1 PC</p>	<p>⑭</p>  <p>1 PC</p>	<p>⑮</p>  <p>1 PC</p>	<p>⑯</p>  <p>1 PC</p>
<p>⑰</p>  <p>2PCS</p>	<p>⑱</p>  <p>2 PSC</p>	<p>⑲</p>  <p>2 PCS</p>	<p>⑳</p>  <p>2PCS</p>
<p>㉒</p>  <p>1 PC</p>	<p>㉓</p>  <p>1 PC</p>	<p>㉔</p>  <p>1PC</p>	



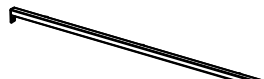

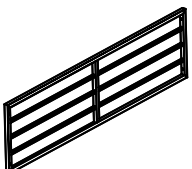
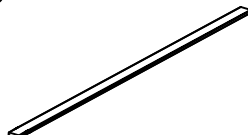
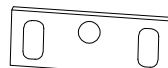
# Parts list /Teileliste /Liste des pièces



N636P288480

<p>①</p>  <p>1PC</p>	<p>②</p>  <p>1PC</p>	<p>④</p>  <p>1PS</p>	<p>⑤</p>  <p>1PC</p>
<p>⑥</p>  <p>1 PC</p>	<p>⑦</p>  <p>1 PC</p>	<p>⑨</p>  <p>1PC</p>	<p>⑩</p>  <p>1PC</p>
<p>⑳</p>  <p>2PCS</p>	<p>㉕</p>  <p>10PCS</p>	<p>㉖</p>  <p>2pcs</p>	

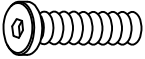
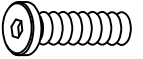
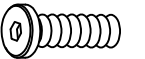
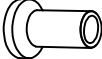
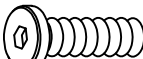
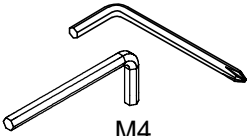
# Parts list /Teileliste /Liste des pièces

N636P288480

<p>A</p>  <p>M4*10</p> <p>4pcs</p>	<p>B</p>  <p>M5*38</p> <p>16pcs</p>	<p>C</p>  <p>M6*10</p> <p>40pcs</p>	<p>D</p>  <p>M6*12</p> <p>6pcs</p>	<p>E</p>  <p>M6*15</p> <p>18pcs</p>
<p>F</p>  <p>M6*17</p> <p>4pcs</p>	<p>G</p>  <p>M6*35</p> <p>18pcs</p>	<p>H</p>  <p>M4</p> <p>1pc</p>	<p>I</p>  <p>1pc</p>	<p>J</p>  <p>1pc</p>

<b>A</b>  M4*10 4pcs	<b>B</b>  M5*38 16pcs
--	---

**DE:**Bitte beachten Sie, dass die Formen der Schrauben A und B und ähnlich sind.Bitte installieren sie entsprechend der Anleitung und unterscheiden sie sie!

**UK:**Please note that the shapes of screws A and B and are similar. Please instalaccording to the instructions and distinguish them!

**FR:**veuillez noter que les vis A et B ont une forme similaire. Suivez les instructions pour les installer pour les séparer!

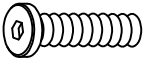
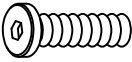
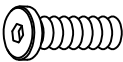
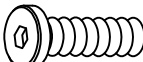

<b>C</b>  M6*10 42pcs	<b>D</b>  M6*12 4pcs	<b>E</b>  M6*15 18pcs	<b>G</b>  M6*35 18pcs
---	--	---	---

**DE:**Bitte beachten Sie, dass die Formen der Schrauben C und D und E und G ähnlich sind.Bitte installieren sie entsprechend der Anleitung und unterscheiden sie sie!

**UK:**Please note that the shapes of screws C and D and E and G are similar. Please instalaccording to the instructions and distinguish them!



**FR:**Notez que les vis C et D et E et G ont des formes similaires. Veuillez les installer en suivant les instructions pour les séparer!

# Step1

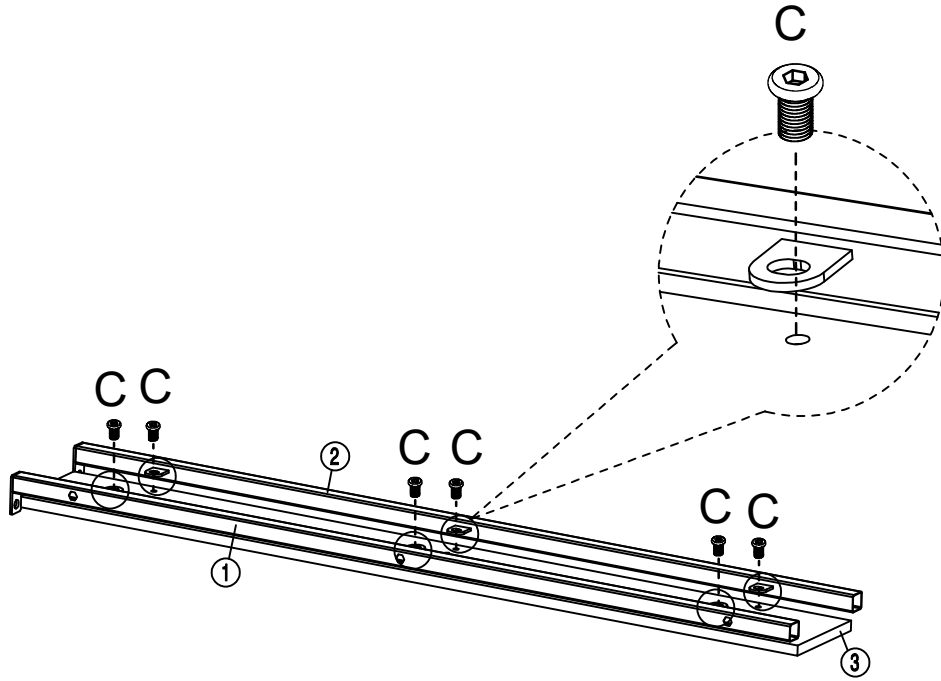
C		M6x10	6
H		M4	



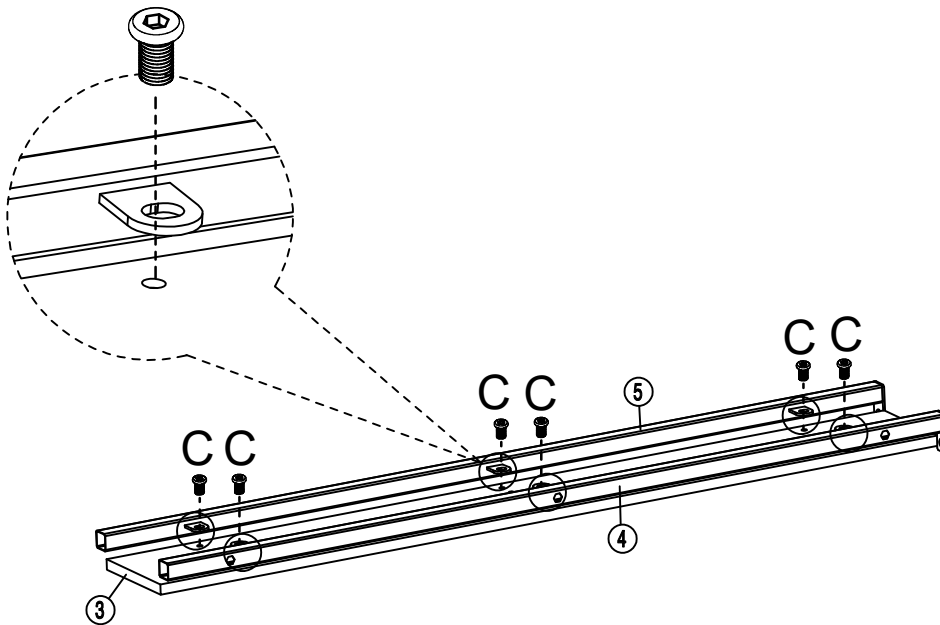

# Step2

C		M6x10	6
H		M4	



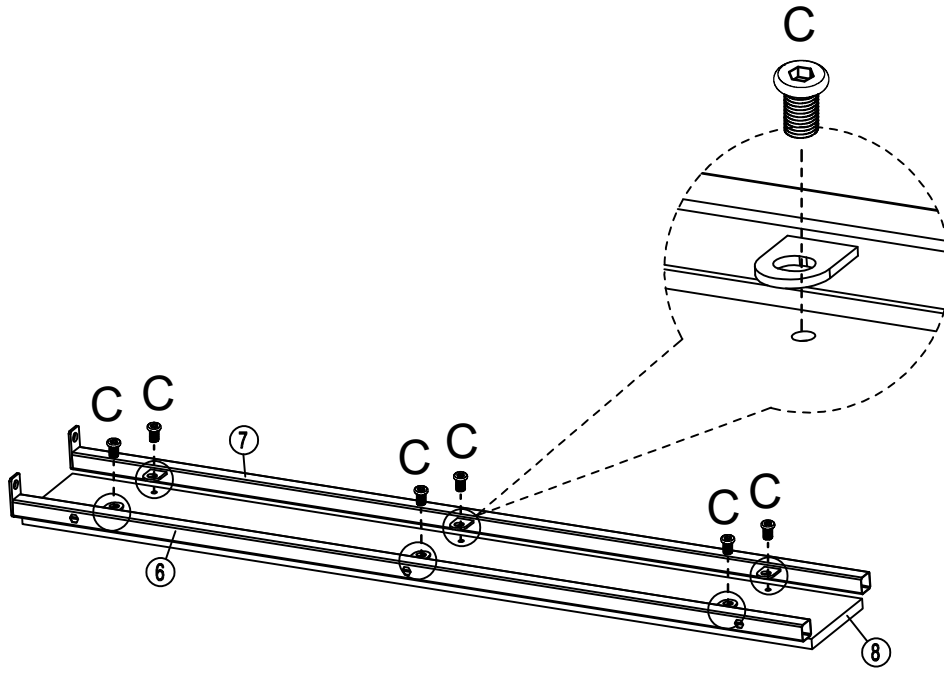

# Step3

C		M6x10	6
H		M4	



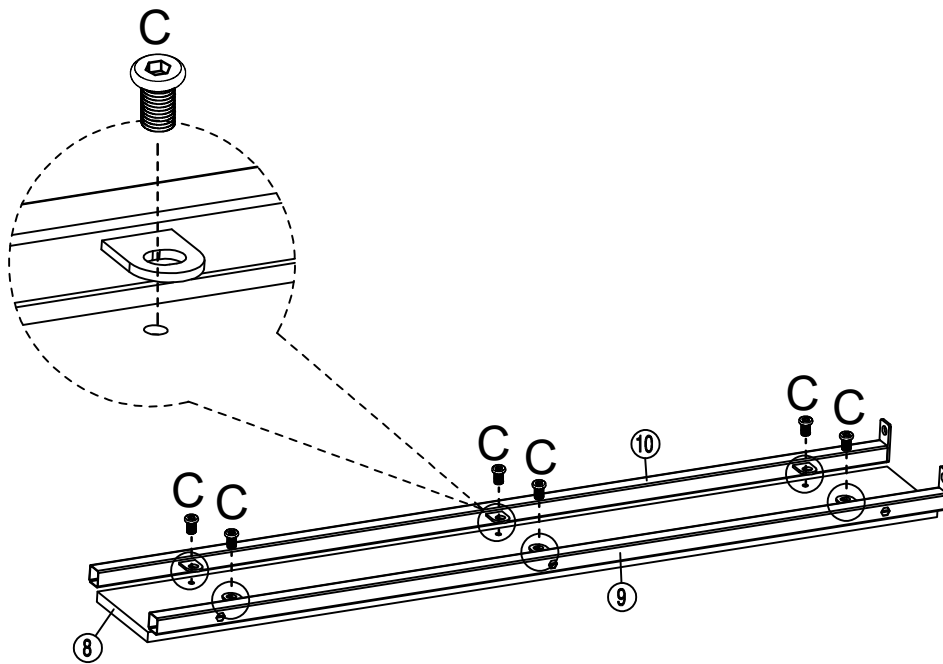

# Step4

C		M6x10	6
H		M4	



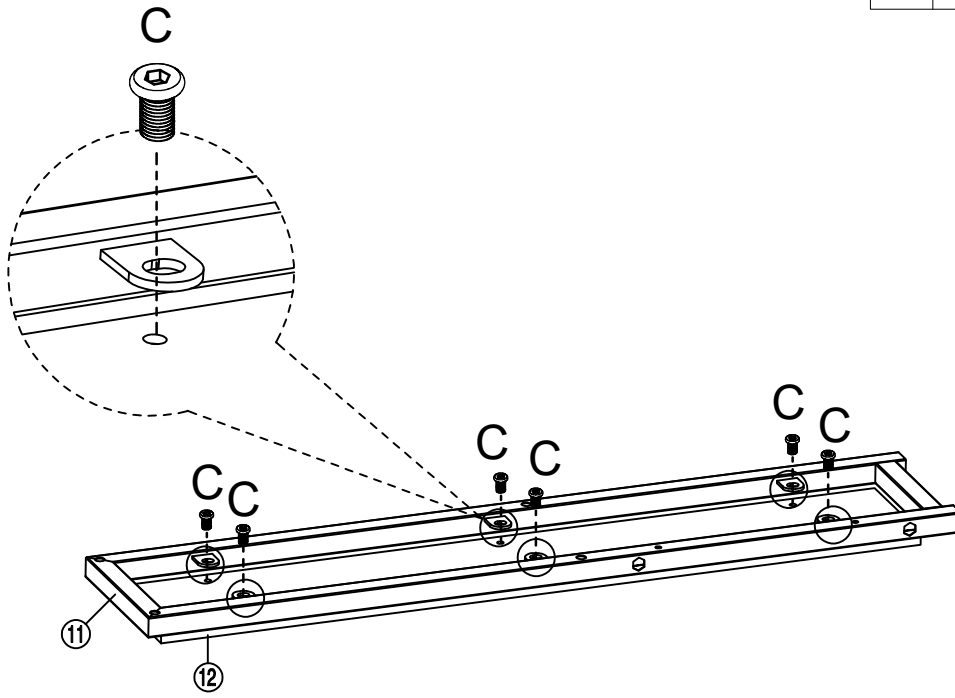

# Step5

C		M6x10	6
H		M4	



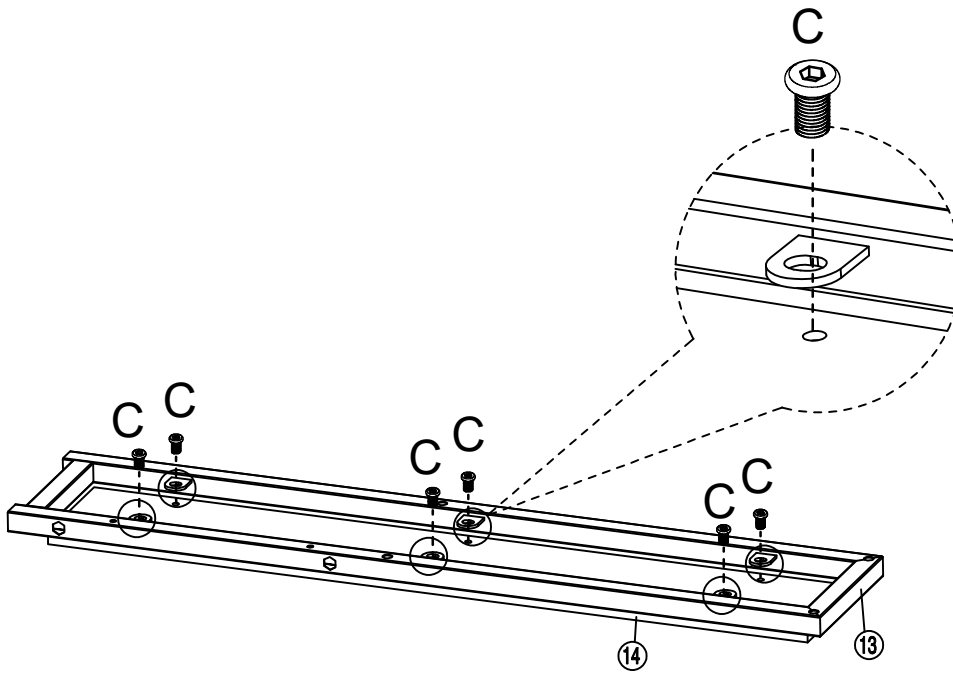

# Step6

C		M6x10	6
H		M4	



# Step7

B		M5x38	4
H		M4	

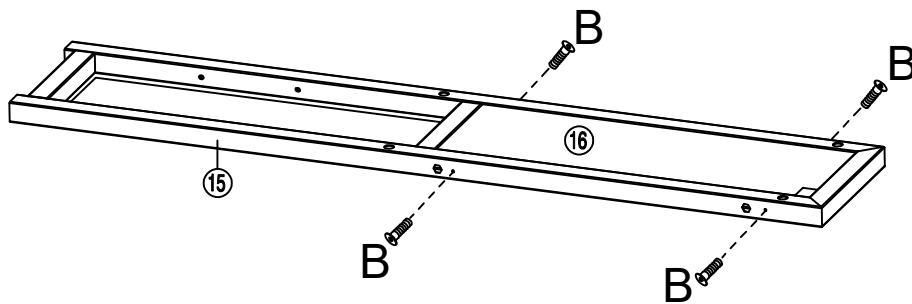

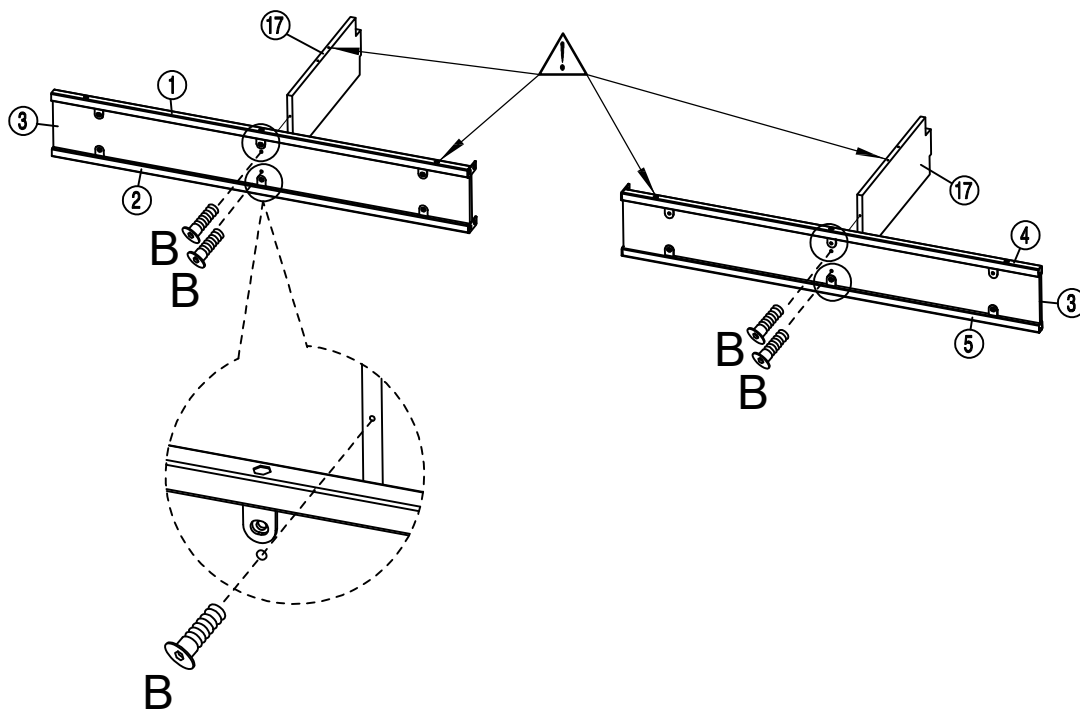

# Step8

B		M5x38	4
H		M4	



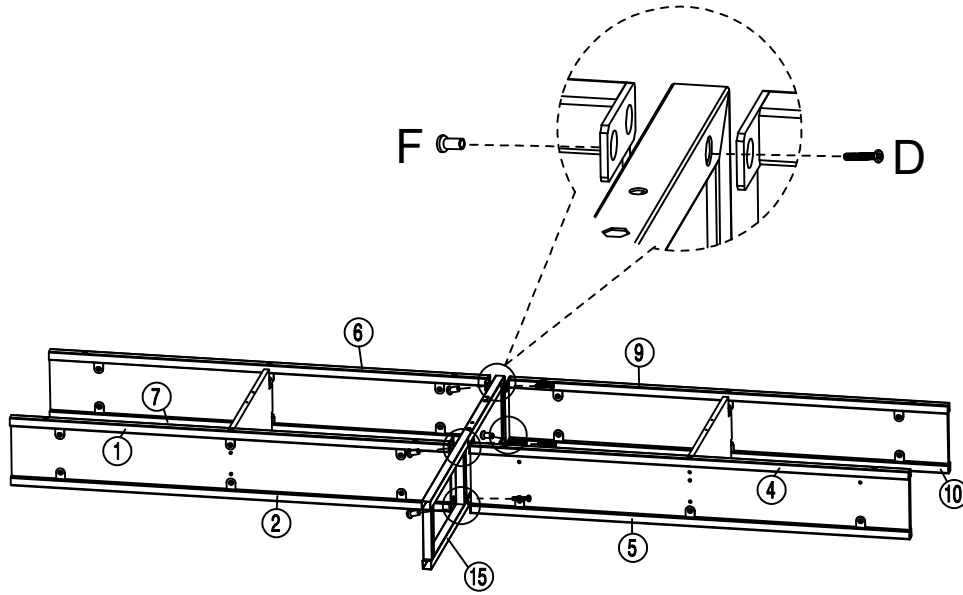

# Step9

D		M6x12	4
F		M6x17	4
H		M4	



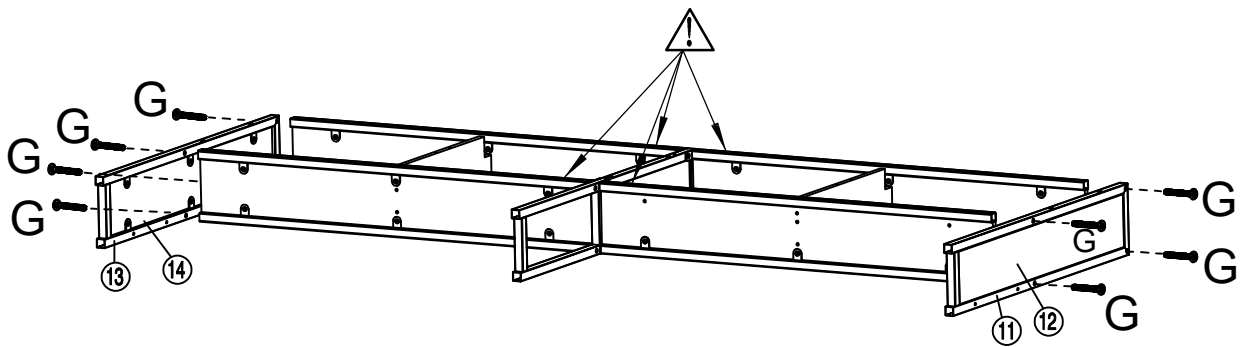

# Step10

G		M6x35	8
H		M4	





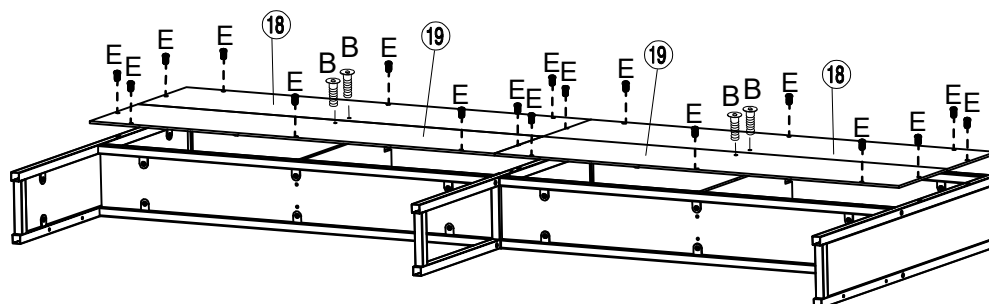

# Step11

E		M6x15	18
B		M5x38	4
H		M4	



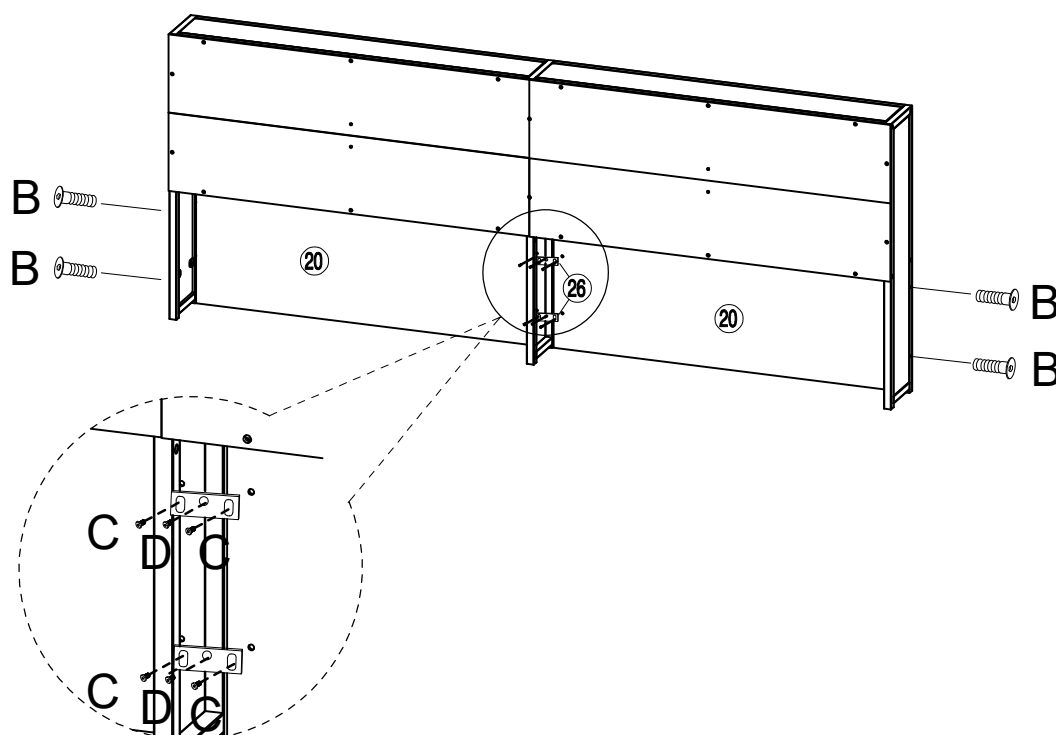

# Step12

C		M6x10	4
B		M5x38	4
H		M4	
D		M6x12	2



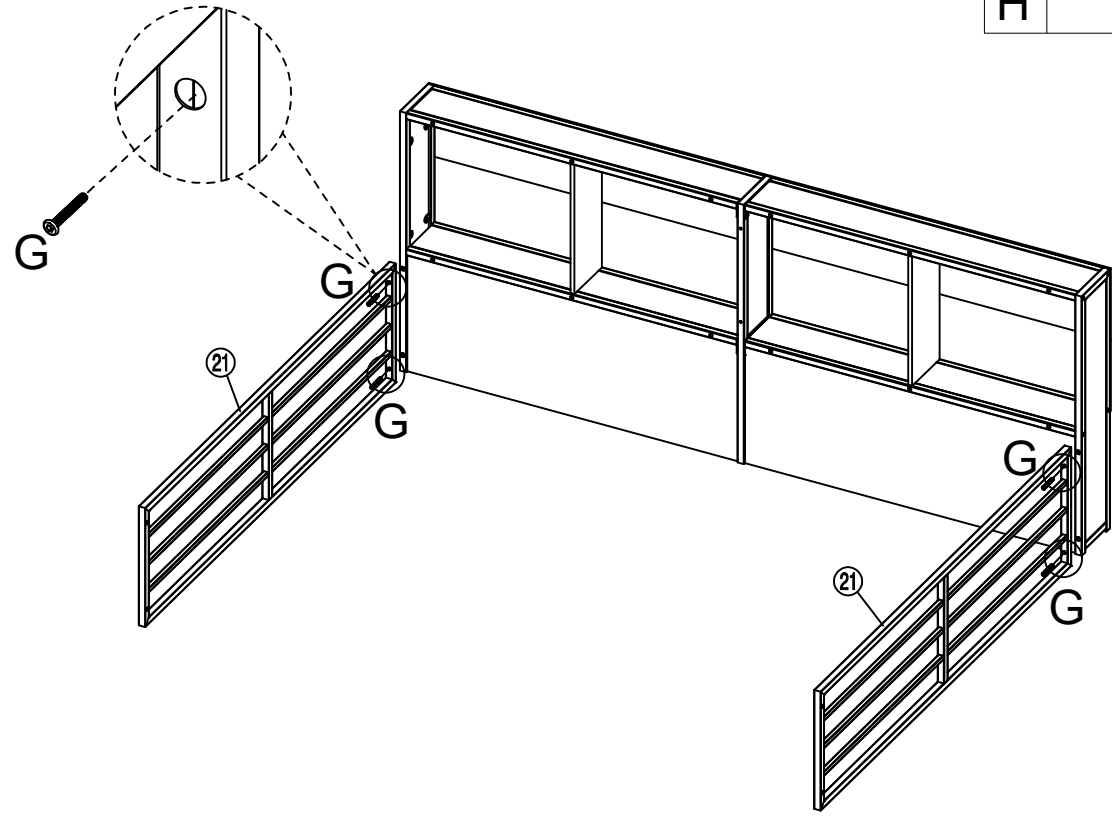

# Step13

G		M6x35	4
H		M4	



# Step14

G		M6x35	6
A		M4x10	4
H		M4	

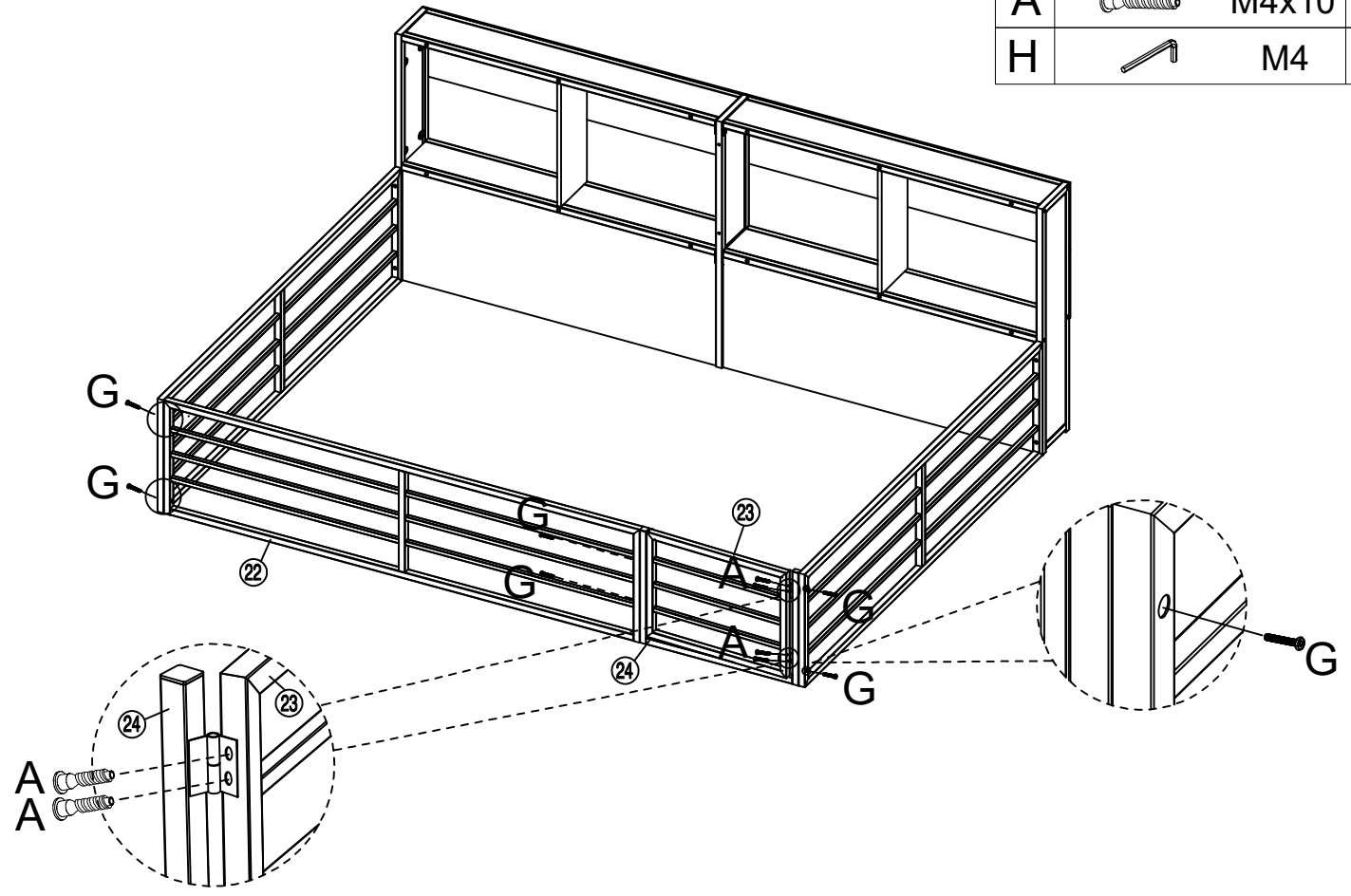

## Step15

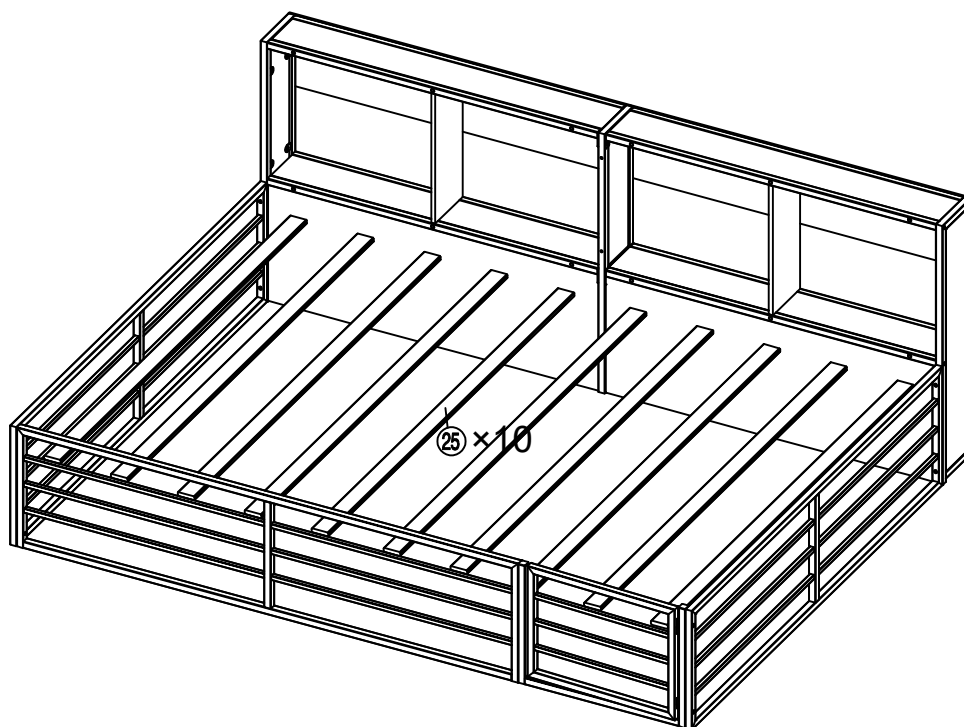

## Step16

I



1

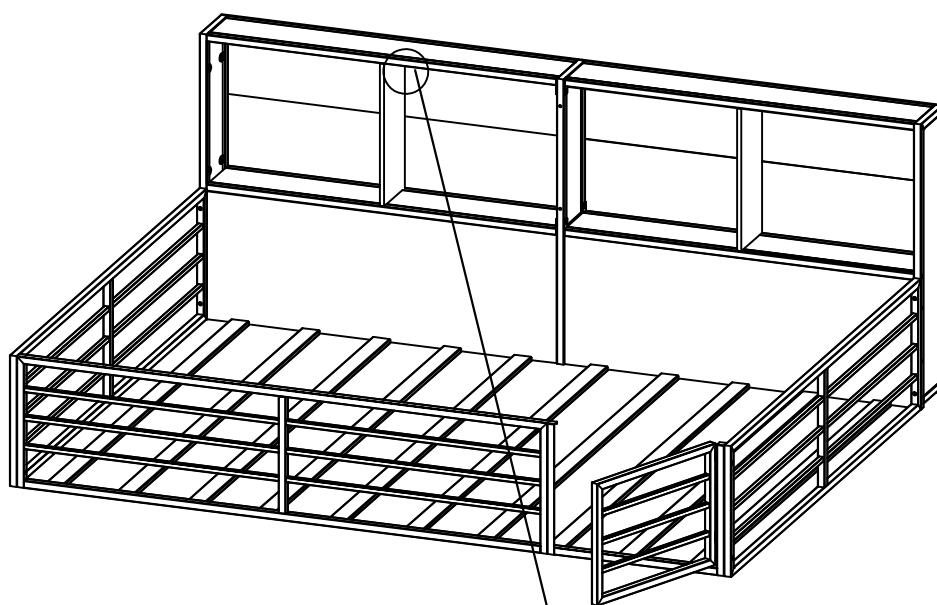

EN: Scan to download App control the Led light.

DE: Scannen, um die App zum Steuern des LED-Lichts herunterzuladen

FR: Scanner pour télécharger App contrôler la lumière Led.

ES: Analice para descargar la aplicación control de la luz Led.

IT: Scansiona per scaricare l'applicazione controlla la luce Led.

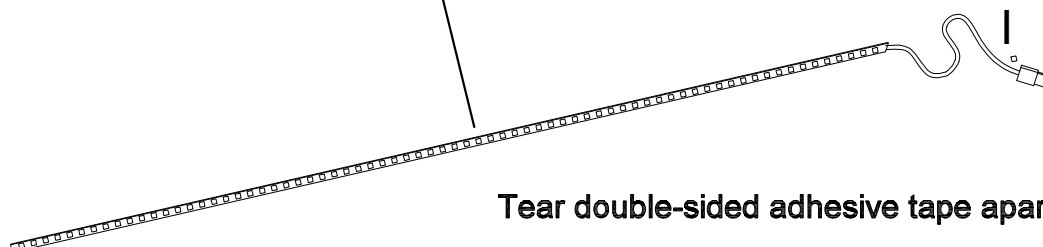

**Tear double-sided adhesive tape apart.**

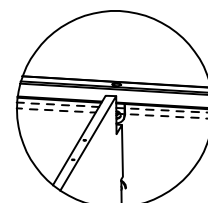

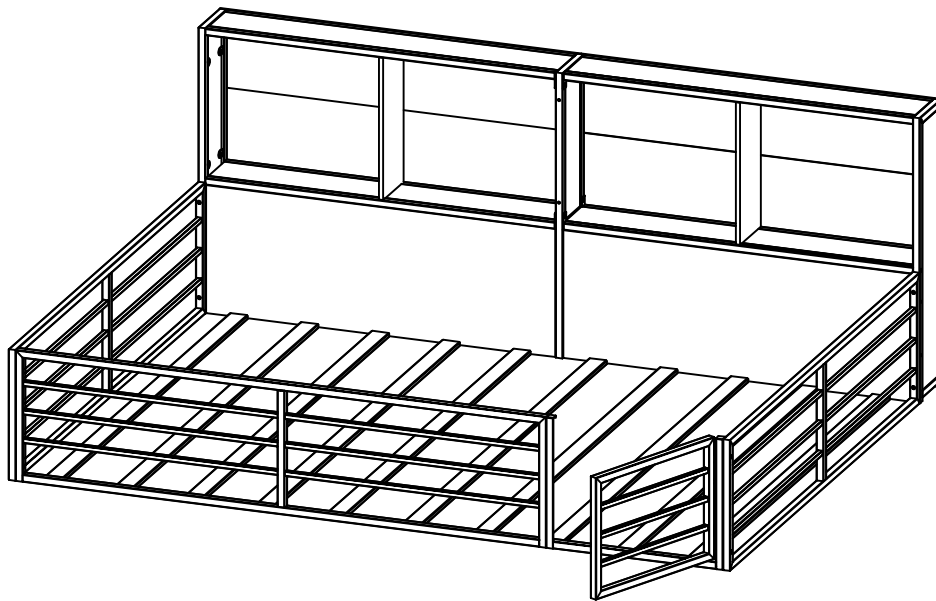
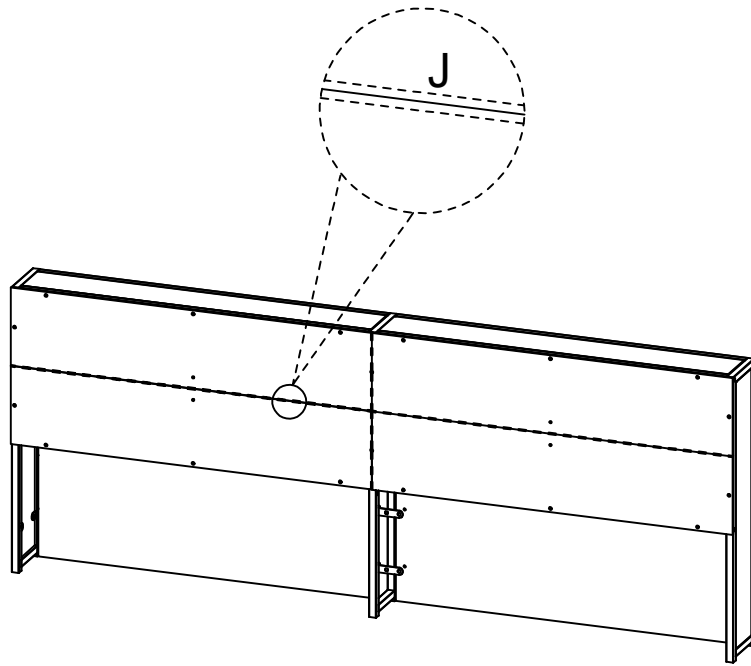

# LotusLantern APP Manual

## 1. Software Overview

### 1.1 Overview

LotusLantern is a mobile APP to control LED strip by both IOS and Android phones. The traditional control ways like infrared, 433MHz, 2.4GHz and others old wired ways will be replaced by mobile phone control way with convenient, powerful and scalable features.

Through this mobile APP , you can not only control the color, brightness and color temperature of the LED strips but also set up all kinds of fancy flash mode ; Also this APP can change the light of the LED strip according to the rhythm of the music. This APP can set and control several LED strips through Bluetooth and the operation is very simple, easy to learn and easy to use.

### 1.2 Features

- Adjust color LED strips with 60,000 colors to change color and brightness and adjust monochrome LED strips to change brightness and color temperature
- Play music or turn on a sound playback device, you can let the light change the color and brightness with the rhythm of music, the music rhythm beautiful
- Inside multiple setting mode for color change and control LED strips without mobile
- Long distance control with omni-directional antenna, and many-to-many group control mode
- Once the connection is successful, connect automatically next time

### 1.3 Performance

LotusLantern APP is easy for use as well as great compatible with all kinds of smart phones; After the actual test of hundreds of mobile phones verification, the compatibility is above 95% of mobile phones in the market. APP is small and convenient, it consumes less system resources, so the requirements of the mobile configuration are low. Control delay is small, the operation feels good, light control is smooth with people's visual sense.

## 2. Operating Environment

This APP program requires phones of system above Andriod 4.3 and iOS 8.0. Mobile phone configuration is not limited.

## 3. Instructions

Note: Android version and iOS version download and use the same method, here in the Android version as an example.

### 3.1 APP Download

Scan the QR code

iOS and Android systems can download the "LotusLantern" APP by scanning the QR code. Open the browser or other tools with "Scan QR code" function, scan the "LotusLantern" QR code as below:



### 3.2 App Operation

(1) Click on the LotusLantern APP icon, enter the APP page:



(2) After entering the APP interface, if Bluetooth is not enabled, "an application wants to enable the Bluetooth function of this device." Click [Allow]



(3) switch to color and brightness interface:

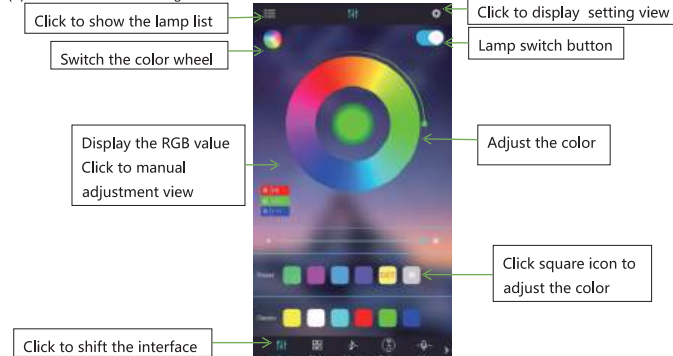

( 4 ) click to show the lamp list, view lamp list:

Bluetooth auto connect  
after search for devices

Lamp list

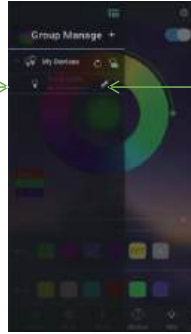

Status of device connection

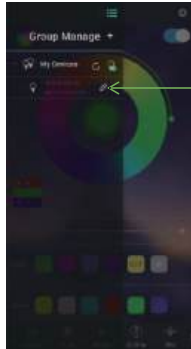

Status of device connection

( 5 ) Click to RGB manual adjustment view:



( 6 ) switch to the mode interface:

Scroll the selection mode

Adjust speed

Adjust brightness



( 7 ) switch to the music rhythm interface:

Previous song, Pause/Play,  
Next song

Plav mode

Music List



( 8 ) Switch to the online music interface:



( 9 ) Switch to the microphone rhythm interface:

Music rhythm through cell phone microphone

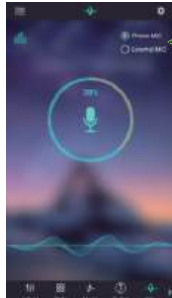

Switch phone microphone and external microphone

Music rhythm through the microphone on the product

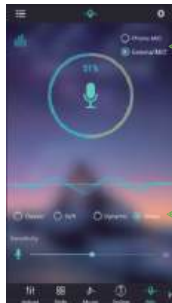

Switch phone microphone and external microphone

4-style rhythm

Change the sensitivity of MIC to match the sound

( 10 ) Switch to the schedule interface:

Set the time of Light-On



Enable or disable the Light-On function

Repeat setting  
No selection for once Light-On

Set the time of Light-Off

Enable or disable the Light-Off function

Repeat setting  
No selection for once Light-Off

( 11 ) Switch to the modify pin sequence interface:

Click to save the new assignment

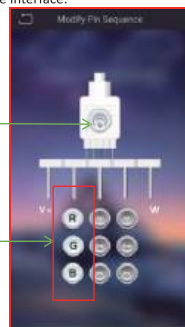

Change the real color of this line

**Technical parameters:**

Working temperature: -20-60°C (-4 F°-140 F°)

Power supply voltage: DC5-24V

Output: 3 Loops

Static power consumption: <0.5W

Output current: <3A(each circuit)5V <30W 12V <108 24V <21 6W

# CERTIFICATE OF COMPLIANCE

No.: AiTSZ-250710061C-C01

**Product:** 5050 RGB LED Strip Lights with Bluetooth App Controller  
**Trade Mark:** N/A  
**Model:** LED 5050 RGB  
**Applicant:** Shenzhen Pinchengxin Technology Co., Ltd  
**Address:** 3rd floor, 8 building Yuanling industrial zon, No. 39 Yuanlingcun road,Shiyan street, Bao'an district, Shenzhen  
**Manufacture:** Shenzhen Pinchengxin Technology Co., Ltd  
**Address:** 3rd floor, 8 building Yuanling industrial zon, No. 39 Yuanlingcun road,Shiyan street, Bao'an district, Shenzhen

The test sample of product has passed the test according to requirements of the following standards:

Standard(s):	Test report(s) No.:
EN 55032:2015+A11:2020 EN 55035:2017+A11:2020	AiTSZ-250710061CE1

Based on the voluntary assessment of the product sample and technical file, we confirm that the above-mentioned product meets the essential requirements of the Electromagnetic Compatibility (EMC) Directive 2014/30/EU.

The CE mark as show below can be used, under the responsibility of the manufacturer or the importer, after completion of an EC declaration of conformity and follow the CE mark usage rules.



Approved by/Date:

*Allen Wang*

Allen.Wang

Jul. 23, 2025



The statement is based on a single evaluation of one sample of above mentioned products. It does not imply an assessment of the whole production and does not permit the use of the test lab's logo.

## Guangdong Asia Hongke Test Technology Limited

B1/F, Building 11, Junfeng Industrial Park, Chongqing Road, Heping Community, Fuhai Street, Bao'an District, Shenzhen, Guangdong, China

www.aitek.org.cn

E-mail:info@aitek.org.cn



# CERTIFICATE OF COMPLIANCE

No.: AiTSZ-250710061C-C01

**Product:** 5050 RGB LED Strip Lights with Bluetooth App Controller  
**Trade Mark:** N/A  
**Model:** LED 5050 RGB  
**Applicant:** Shenzhen Pinchengxin Technology Co., Ltd  
**Address:** 3rd floor, 8 building Yuanling industrial zon, No. 39 Yuanlingcun road,Shiyan street, Bao'an district, Shenzhen  
**Manufacture:** Shenzhen Pinchengxin Technology Co., Ltd  
**Address:** 3rd floor, 8 building Yuanling industrial zon, No. 39 Yuanlingcun road,Shiyan street, Bao'an district, Shenzhen

The test sample of product has passed the test according to requirements of the following standards:

	Standard(s):	Test report(s) No.:
Article 3.1a)	EN IEC 62368-1:2020+A11:2020	AiTSZ-250710061S
	EN 62479: 2010 EN 50663: 2017	AiTSZ-250710061CW3
Article 3.1b)	ETSI EN 301 489-1 V2.2.3 (2019-11) ETSI EN 301 489-17 V3.2.4 (2020-09)	AiTSZ-250710061CW1
Article 3.2)	ETSI EN 300 328 V2.2.2 (2019-07)	AiTSZ-250710061CW2

Based on the voluntary assessment of the product sample and technical file, we confirm that the above-mentioned product meets the essential requirements of the Radio Equipment Directive (RED) 2014/53/EU.

The CE mark as show below can be used, under the responsibility of the manufacturer or the importer, after completion of an EC declaration of conformity and follow the CE mark usage rules.



Approved by/Date:

*Sean She*

July 23, 2025

Sean She



The statement is based on a single evaluation of one sample of above mentioned products. It does not imply an assessment of the whole production and does not permit the use of the test lab's logo.

## Guangdong Asia Hongke Test Technology Limited

B1/F, Building 11, Junfeng Industrial Park, Chongqing Road, Heping Community, Fuhai Street, Bao'an District, Shenzhen, Guangdong, China

www.aitek.org.cn

E-mail:info@aitek.org.cn

