

# MONTAGEANLEITUNG//ASSEMBLY INSTRUCTION

Artikelnummer/Item Number: N622P391736  
N622P391737

Unser Bett wird in 2 Paketen geliefert. Die Lieferzeit dieser 2 Pakete können abweichen. bittehaben Sie etwas Geduld und vielen Dank furlhr Verstandnis.

Our bed will be sent to you in 2 packages. The delivery time of these 2 parcels may be different. Please be patient. Thank you for your understanding.

## Bett 200x90cm

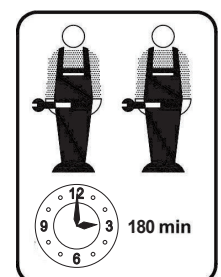
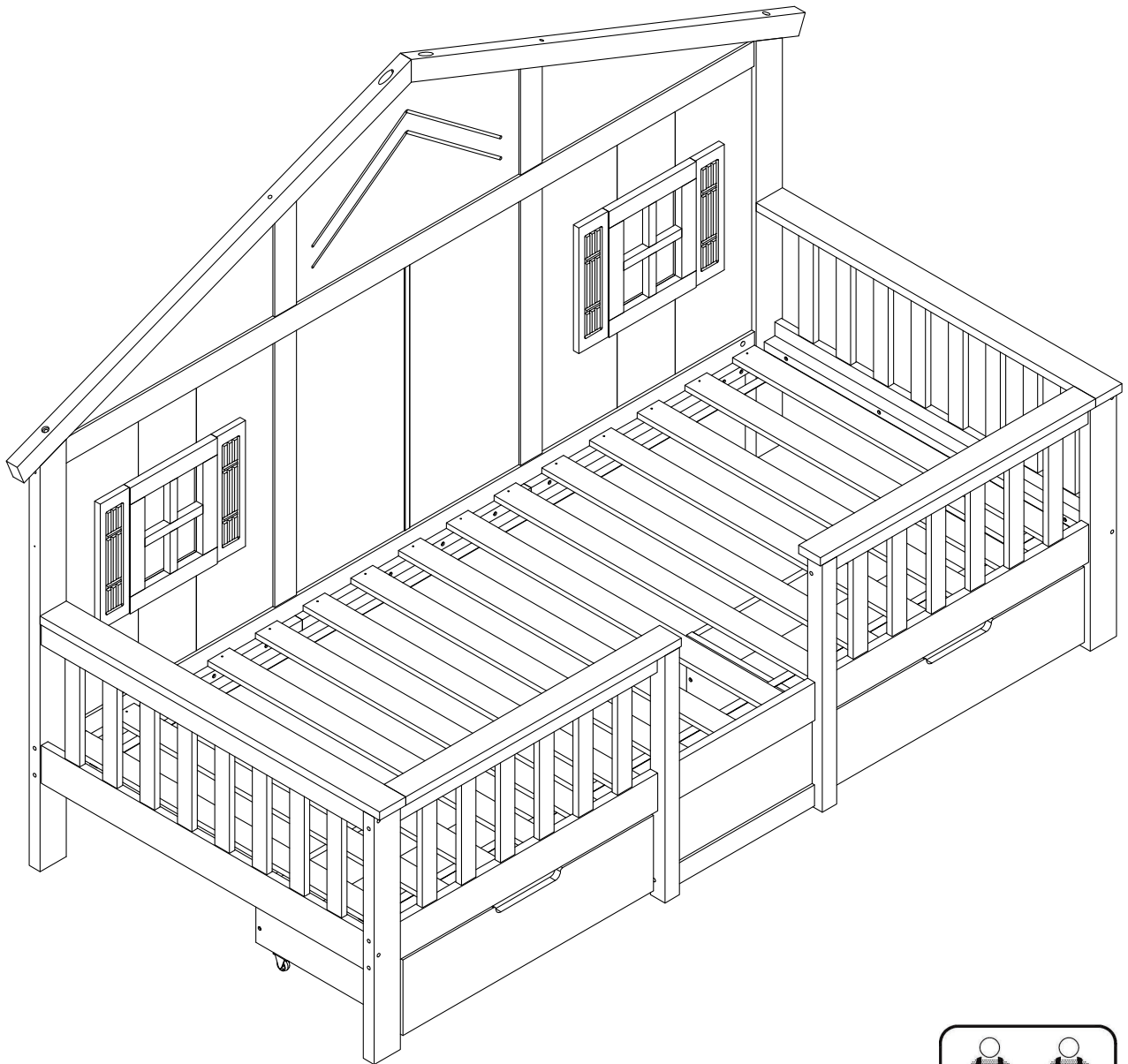

## English

### IMPORTANT ! KEEP FOR FUTURE REFERENCE : READ CAREFULLY

- To be assembled by an adult. Assembly must be checked by an adult before use
- WARNING ! Keep all screws, small parts and plastic bags out of the reach of children
- Properly identify all parts before assembling
- Never use your item if any of its parts are broken or missing
- Should any problems arise, please contact our After Sales Service
- Manufacturer's instructions shall be followed at all times
- Care: Clean with a soft, dry cloth. In case of larger stains, carefully rub with a slightly damp, non-abrasive sponge
- Avoid the risk of fire by not placing furniture near sources of ignition or hot items
- Do not jump on the bed

## Deutsch

### WICHTIG ! ZUM SPÄTEREN NACHSCHLAGEN AUFBEWAHREN: SORGFÄLTIG LESEN

- Muss von einem Erwachsenen zusammengebaut werden. Der Zusammenbau muss vor dem Gebrauch von einem Erwachsenen überprüft werden
- WARNUNG! Bewahren Sie alle Schrauben, Kleinteile und Plastikbeutel außerhalb der Reichweite von Kindern auf
- Kennzeichnen Sie vor dem Zusammenbau alle Teile richtig
- Benutzen Sie Ihren Artikel niemals, wenn Teile gebrochen sind oder fehlen
- Sollten Probleme auftreten, wenden Sie sich bitte an unseren Kundendienst
- Die Anweisungen des Herstellers sind stets zu befolgen
- Pflege: Mit einem weichen, trockenen Tuch reinigen. Bei größeren Flecken vorsichtig mit einem leicht feuchten, nicht scheuernden Schwamm abreiben. nicht scheuernden Schwamm
- Vermeiden Sie die Gefahr eines Brandes, indem Sie die Möbel nicht in der Nähe von Zündquellen oder heißen Gegenständen aufstellen
- Nicht auf das Bett springen

## Français

### IMPORTANT ! CONSERVER POUR RÉFÉRENCE ULTÉRIEURE : LIRE ATTENTIVEMENT

- Le montage doit être effectué par un adulte. Le montage doit être vérifié par un adulte avant Utilisation
- ATTENTION ! Tenir les vis, les petites pièces et les sachets en plastique hors de portée des enfants
- Identifiez correctement toutes les pièces avant de les assembler
- N'utilisez jamais votre article si l'une de ses pièces est cassée ou manquante
- En cas de problème, veuillez contacter notre service après-vente
- Les instructions du fabricant doivent être respectées à tout moment
- Entretien : nettoyer avec un chiffon doux et sec. En cas de taches plus importantes, frotter soigneusement avec une éponge non abrasive légèrement humide. légèrement humide et non Abrasive
- Évitez les risques d'incendie en ne plaçant pas les meubles à proximité de sources d'inflammation ou d'objets chauds
- Ne pas sauter sur le lit

## Italiano

### IMPORTANTE! CONSERVARE PER RIFERIMENTO FUTURO: LEGGERE ATTENTAMENTE

- Deve essere assemblato da un adulto. L'assemblaggio deve essere controllato da un adulto prima dell'uso
- **ATTENZIONE!** Tenere tutte le viti, le piccole parti e i sacchetti di plastica fuori dalla portata dei bambini
- Identificare correttamente tutte le parti prima dell'assemblaggio
- Non utilizzare mai l'articolo se alcune parti sono rotte o mancanti
- In caso di problemi, si prega di contattare il nostro Servizio Post Vendita
- Le istruzioni del produttore devono essere sempre seguite
- Cura: Pulire con un panno morbido e asciutto. In caso di macchie più estese, strofinare accuratamente con una spugna leggermente umida e nonspugna leggermente umida e non abrasiva
- Evitare il rischio di incendio, non collocando i mobili vicino a fonti di accensione o a oggetti caldi
- Non saltare sul letto

## Español

### ¡ IMPORTANTE ! CONSERVELO PARA FUTURAS CONSULTAS: LEA ATENTAMENTE

- Debe ser montado por un adulto. El montaje debe ser comprobado por un adulto antes del uso
- ADVERTENCIA Mantenga todos los tornillos, piezas pequeñas y bolsas de plástico fuera del alcance de los niños.
- Identifique correctamente todas las piezas antes de montarlas
  - Nunca utilice su artículo si alguna de sus piezas está rota o falta
  - Si surge algún problema, póngase en contacto con nuestro Servicio Postventa
  - Las instrucciones del fabricante deben seguirse en todo momento
  - Cuidado: Limpiar con un paño suave y seco. En caso de manchas más grandes, frote cuidadosamente con una esponja no abrasiva ligeramente humedecida.
  - Evite el riesgo de incendio no colocando los muebles cerca de fuentes de ignición u objetos calientes.
  - No saltar sobre la cama.

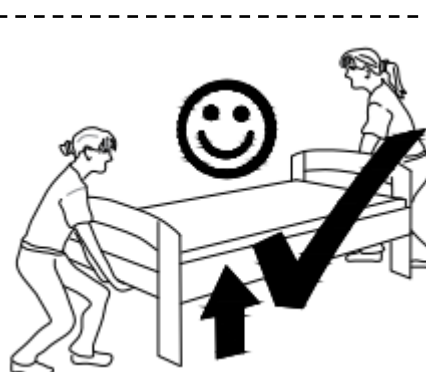
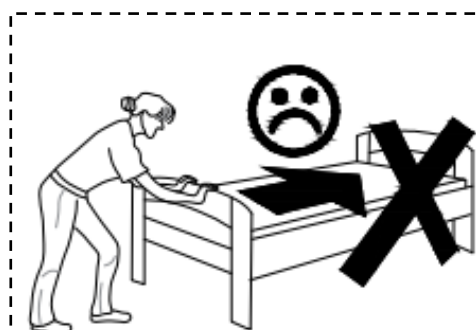

# INSTRUCTIONS

## IMPORTANT-READ CAREFULLY-RETAIN FOR FUTURE REFERENCE

- a) **WARNING** -Children can become trapped between the bed and the wall, the adjoining pieces of furniture (e.g. cupboards) and the like. To avoid risk of serious injury the distance between the safety barrier and the adjoining structure shall not exceed 90 mm or shall be more than 230 mm.
- b) **WARNING**-Do not use the bed if any structural part is broken or missing; Replacement parts are between requested from the manufacturer or the store.
- c) **WARNING**-Do not climb or wiggle on any non-designated structures.
- d) it is imperative to always follow the installation instructions and manufacturer's use.
- e) **The recommended size of the mattress to be used with the bed is 200cmx90cm, maximum thickness mattress:13cm.**
- f) It is necessary to ventilate the room in order to maintain a low level moisture and prevent mold growth in the bed and its periphery.
- g) Joining devices should always be tightened properly and regularly verified. Tighten if necessary.

# ANLEITUNGEN

## WICHTIG - SORGFÄLTIG LESEN - FÜR SPÄTERE VERWENDUNG

### AUFBEWAHREN

- a) **WARNUNG** - Kinder können zwischen dem Bett und der Wand, den angrenzenden Möbelstücken (z. B. Schränken) und der Lücke eingeklemmt werden. Um die Gefahr schwerer Verletzungen zu vermeiden, darf der Abstand zwischen der Sicherheitsbarriere und der angrenzenden Struktur nicht mehr als 90 mm oder mehr als 230 mm betragen.
- b) **WARNUNG**-Das Bett darf nicht benutzt werden, wenn ein Bauteil gebrochen ist oder fehlt; Ersatzteile sind beim Hersteller oder im Geschäft anzufordern.
- c) **WARNUNG** - Klettern oder wackeln Sie nicht auf nicht dafür vorgesehenen Strukturen.
- d) Befolgen Sie unbedingt die Installationsanweisungen und die Gebrauchsanweisungen des Herstellers.
- e) **Die empfohlene Größe der Matratze für das Bett beträgt 200x90cm, maximale Dicke der Matratze: 13cm.**
- f) Es ist notwendig, den Raum zu lüften, um die Feuchtigkeit niedrig zu halten und Schimmelbildung im Bett und seiner Umgebung zu verhindern.
- g) Die Verbindungselemente sollten immer richtig angezogen sein und regelmäßig überprüft werden. Ziehen Sie sie gegebenenfalls nach.

# Stückliste

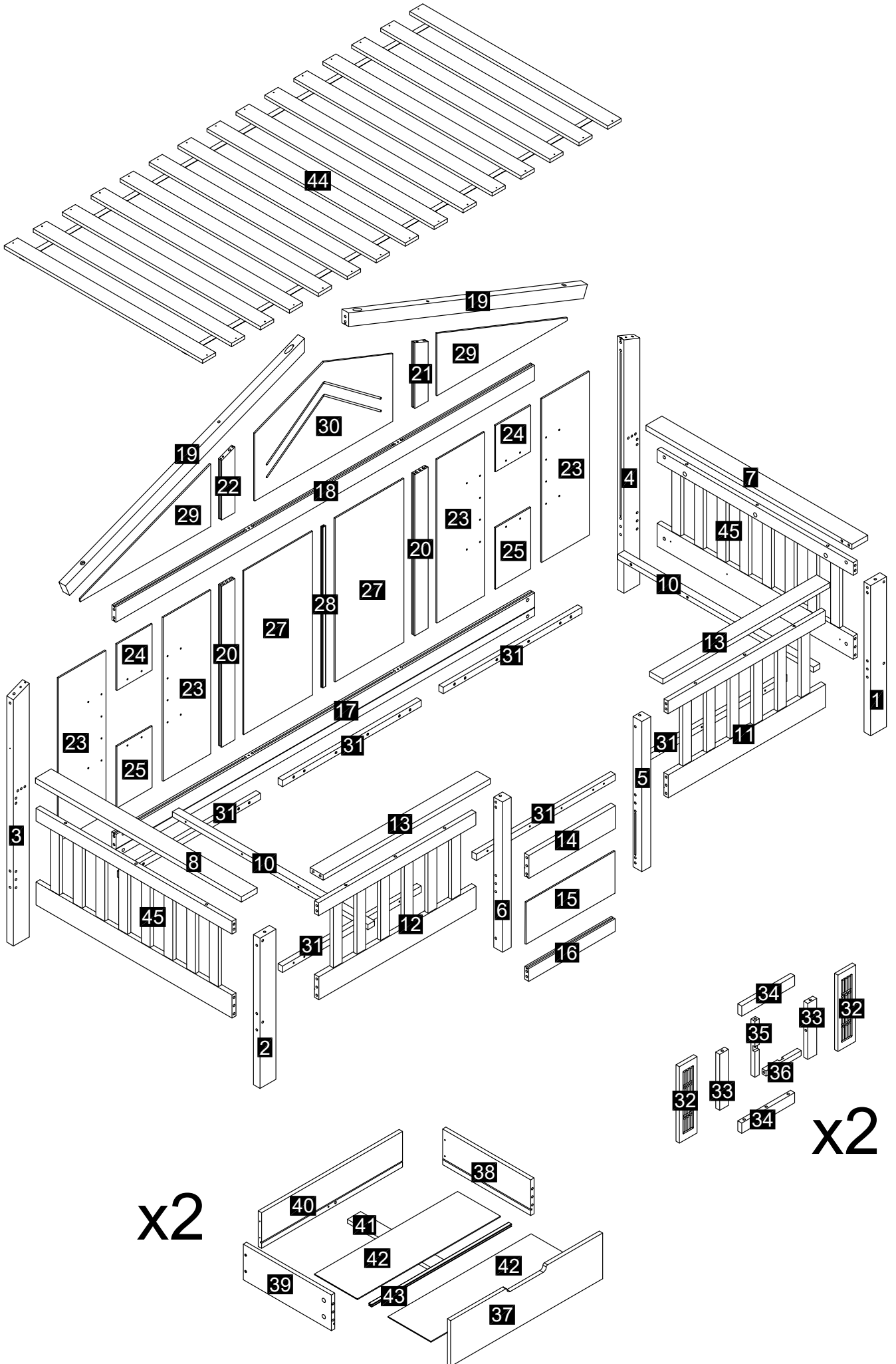







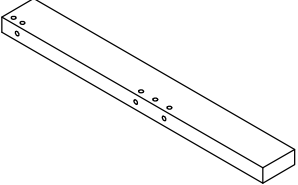
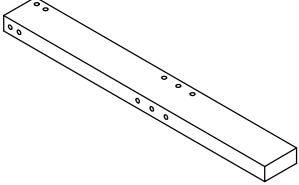
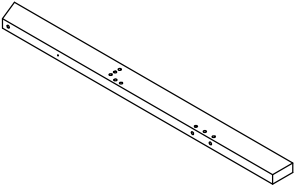
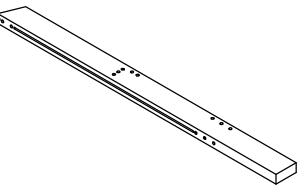
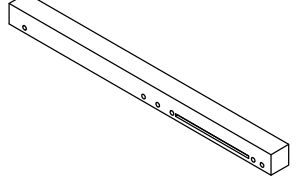
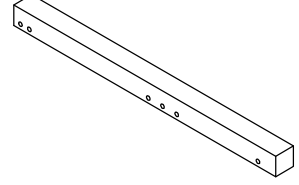
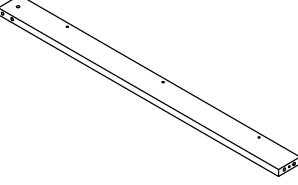
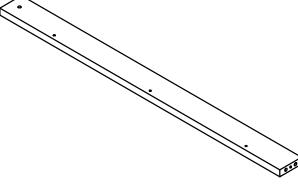
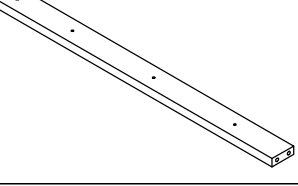
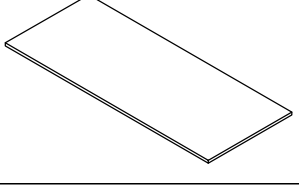
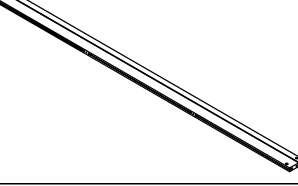
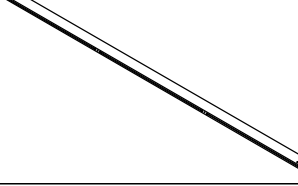
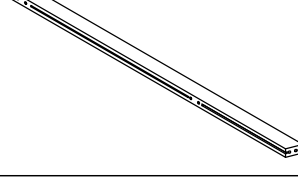
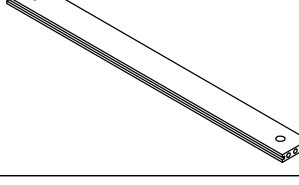
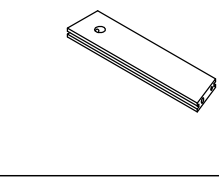
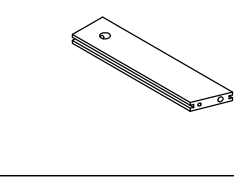
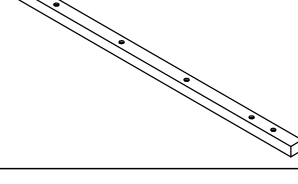
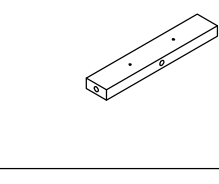
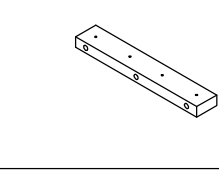
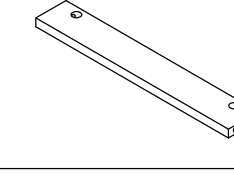
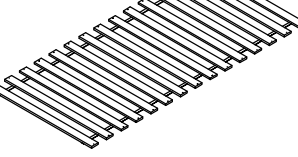



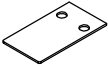



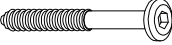

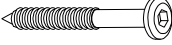

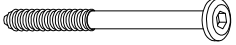
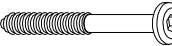
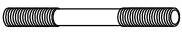
x2

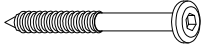
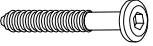

x2

# N622P391736

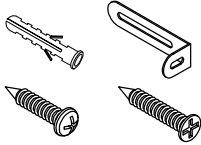

<b>1</b> x1 	<b>2</b> x1 	<b>3</b> x1 	<b>4</b> x1 
<b>5</b> x1 	<b>6</b> x1 	<b>7</b> x1 	<b>8</b> x1 
<b>13</b> x2 	<b>15</b> x1 	<b>17</b> x1 	<b>18</b> x1 
<b>19</b> x2 	<b>20</b> x2 	<b>21</b> x1 	<b>22</b> x1 
<b>31</b> x6 	<b>33</b> x4 	<b>34</b> x4 	<b>41</b> x2 
<b>44</b> x1 			

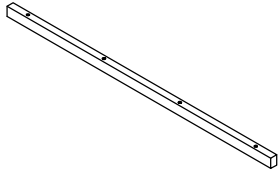
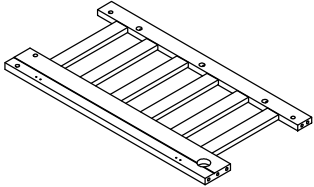
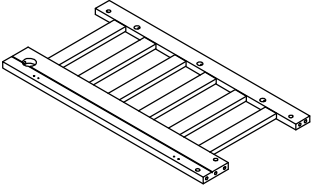
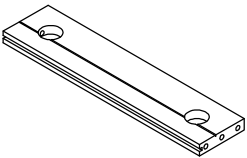
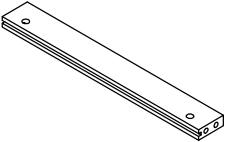
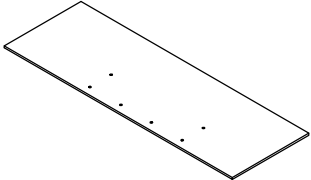
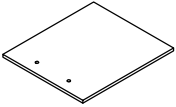
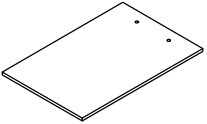
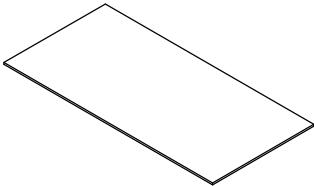
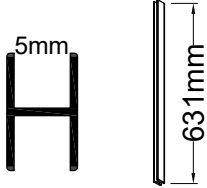
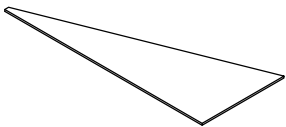
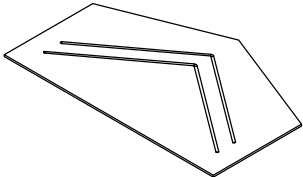
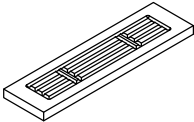
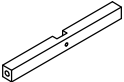
# Hardware-Liste N622P391736

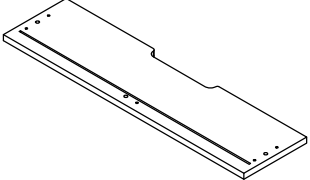
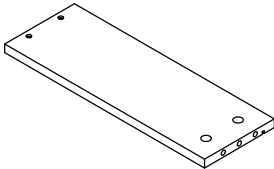
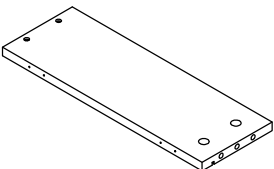
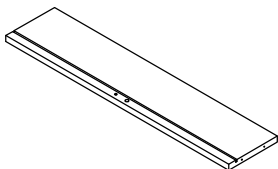
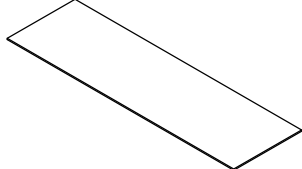
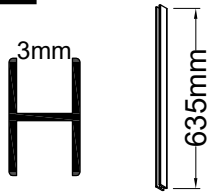
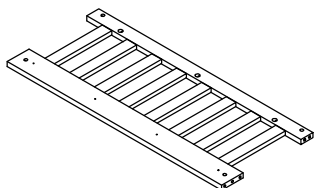
<p>A x85</p>  <p>Φ8x30</p>	<p>B x4</p> 	<p>C x24</p>  <p>Φ3.5x16</p>	<p>D x30</p> 	<p>E x30</p> 
<p>F x8</p>  <p>M6x70</p>	<p>G x24</p> 	<p>H x2</p>  <p>Φ6x70</p>	<p>I x16</p>  <p>Φ4x40</p>	<p>J x12</p>  <p>M6x120</p>
<p>K x4</p>  <p>M6x80</p>	<p>L x2</p>  <p>120mm</p>	<p>M x4</p> 	<p>N x2</p> 	<p>O x4</p>  <p>Φ6x80</p>
<p>P x1</p>  <p>M6x50</p>	<p>Q x1</p> 	<p>R x2</p>  <p>Φ4x14</p>	<p>S x32</p>  <p>Φ4x16</p>	<p>T x36</p>  <p>Φ4x30</p>
<p>U x30</p>  <p>Φ3x30</p>	<p>V x8</p> 	<p>W x2</p> 	<p>X x2</p> 	

<p><b>10</b> x2</p> 	<p><b>11</b> x1</p> 	<p><b>12</b> x1</p> 	<p><b>14</b> x1</p> 
<p><b>16</b> x1</p> 	<p><b>23</b> x4</p> 	<p><b>24</b> x2</p> 	<p><b>25</b> x2</p> 
<p><b>27</b> x2</p> 	<p><b>28</b> x1</p> 	<p><b>29</b> x2</p> 	<p><b>30</b> x1</p> 
<p><b>32</b> x4</p> 	<p><b>35</b> x2</p> 	<p><b>36</b> x2</p> 	<p><b>37</b> x2</p> 
<p><b>38</b> x2</p> 	<p><b>39</b> x2</p> 	<p><b>40</b> x2</p> 	<p><b>42</b> x4</p> 
<p><b>43</b> x2</p> 	<p><b>45</b> x2</p> 		

# Schritt 1

A	 Φ8x30 77	B		4
C	 Φ3.5x16 8			

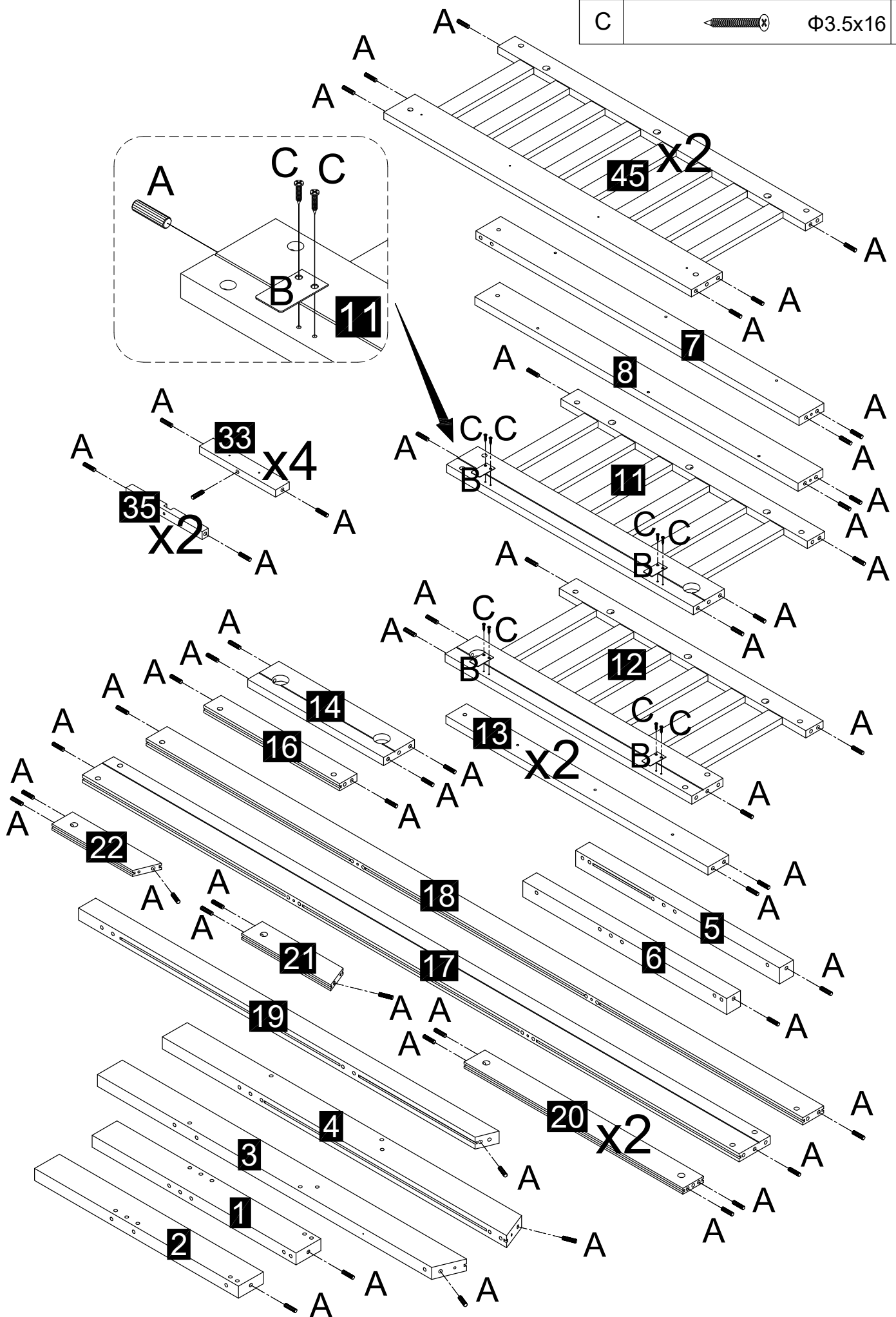

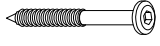

# Schritt 4

E		6
H		Φ6x70 2

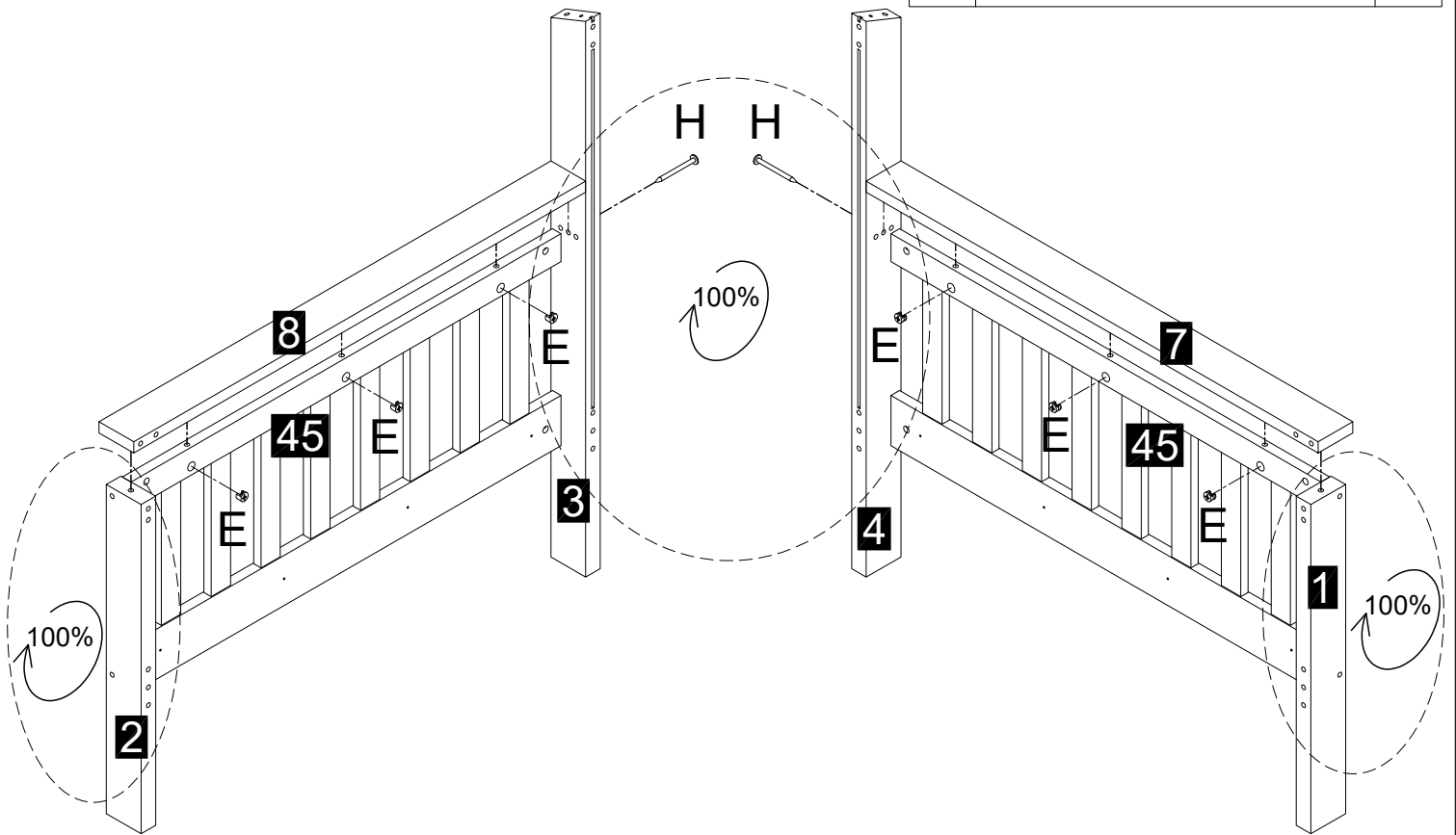

# Schritt 5

I		Φ4x40 8
---	---	---------

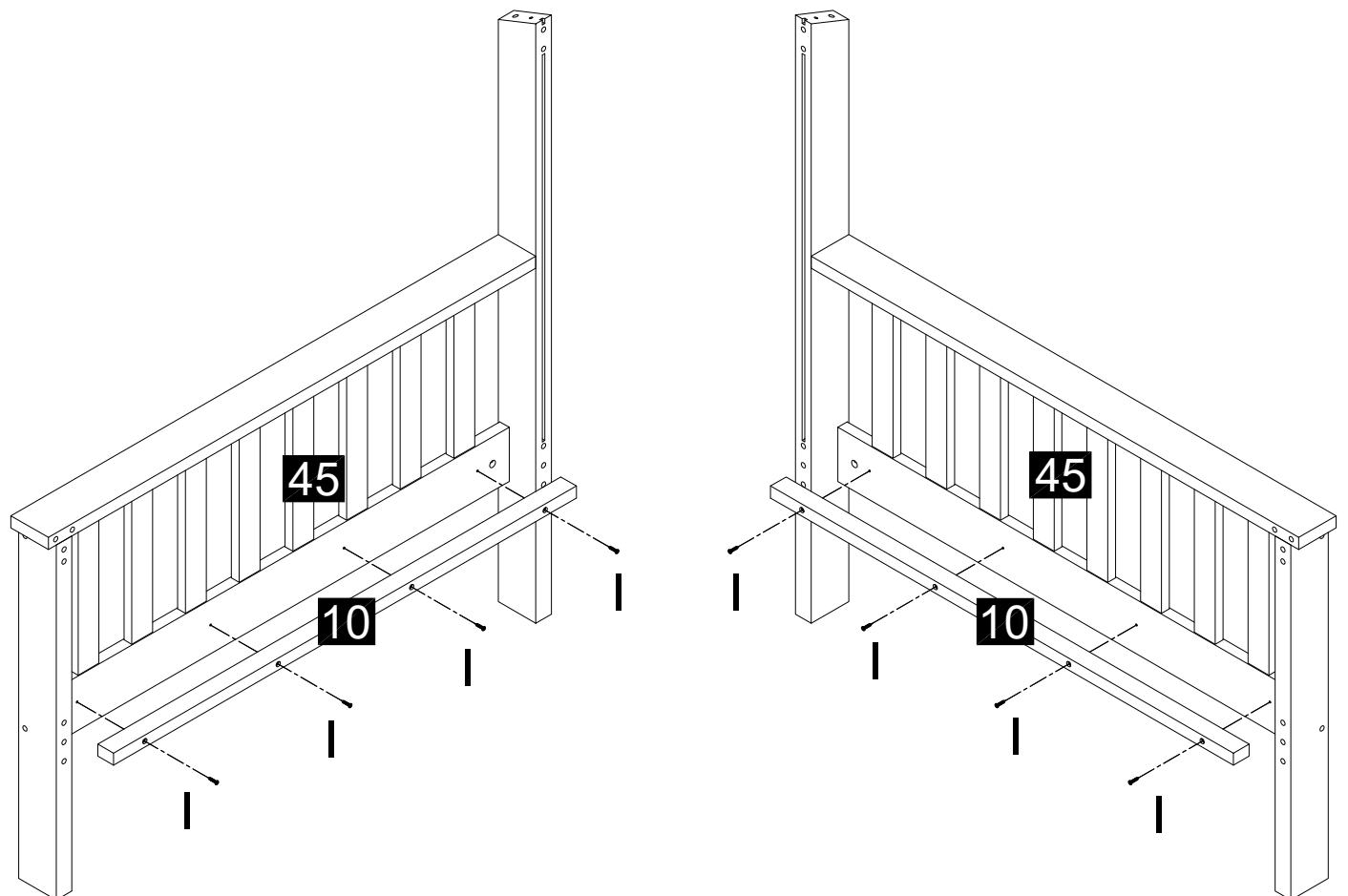

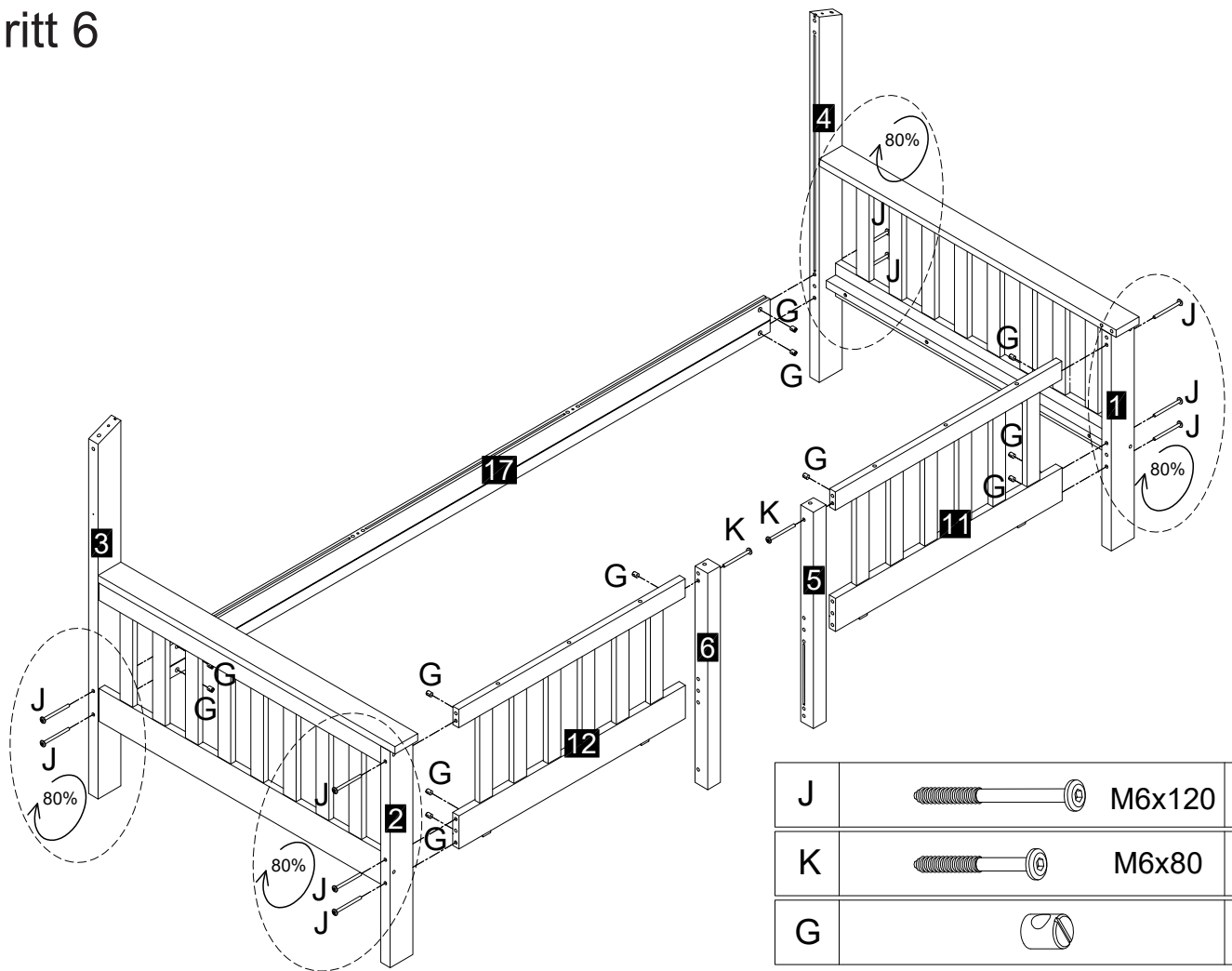

# Schritt 6

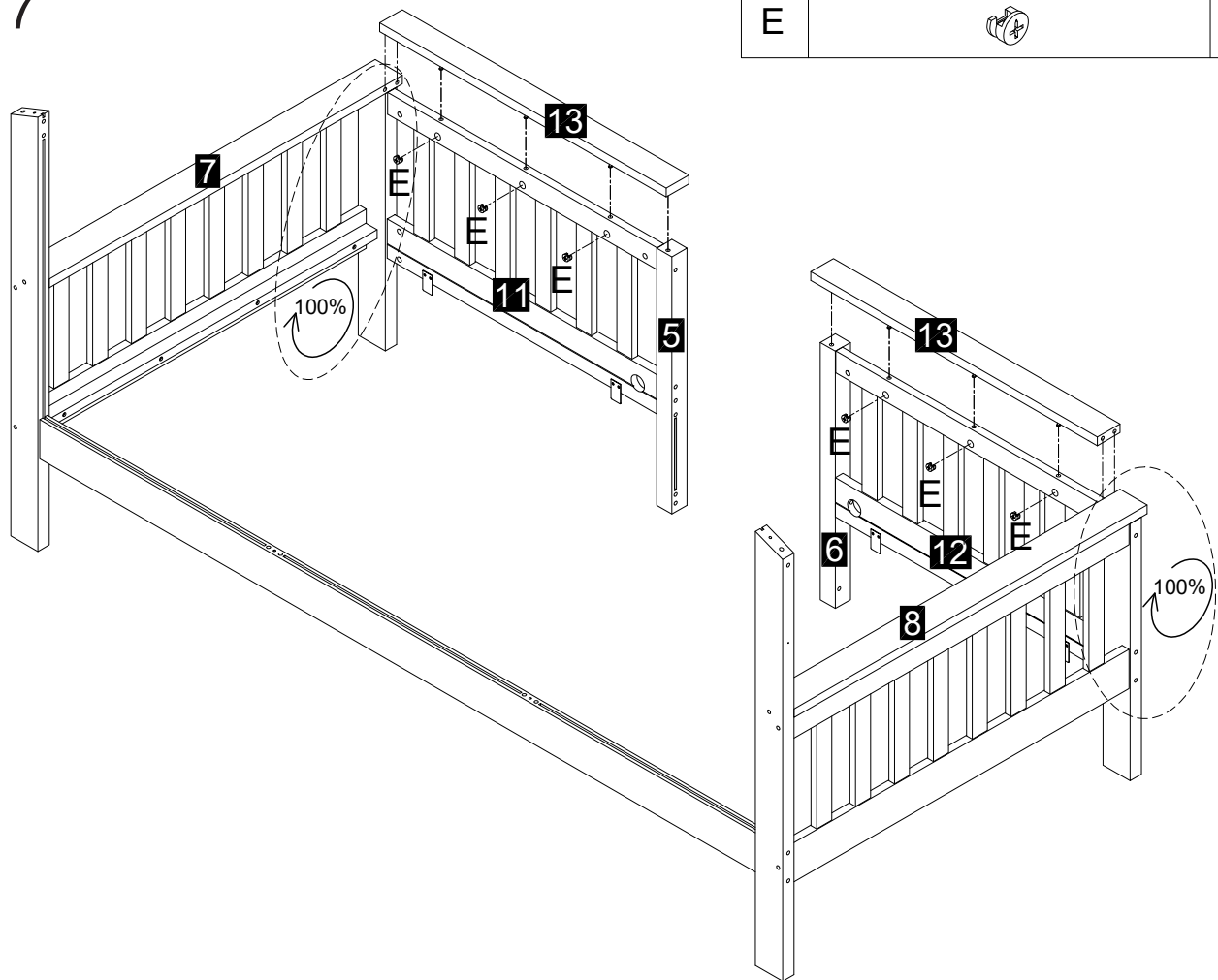

# Schritt 7



# Schritt 8

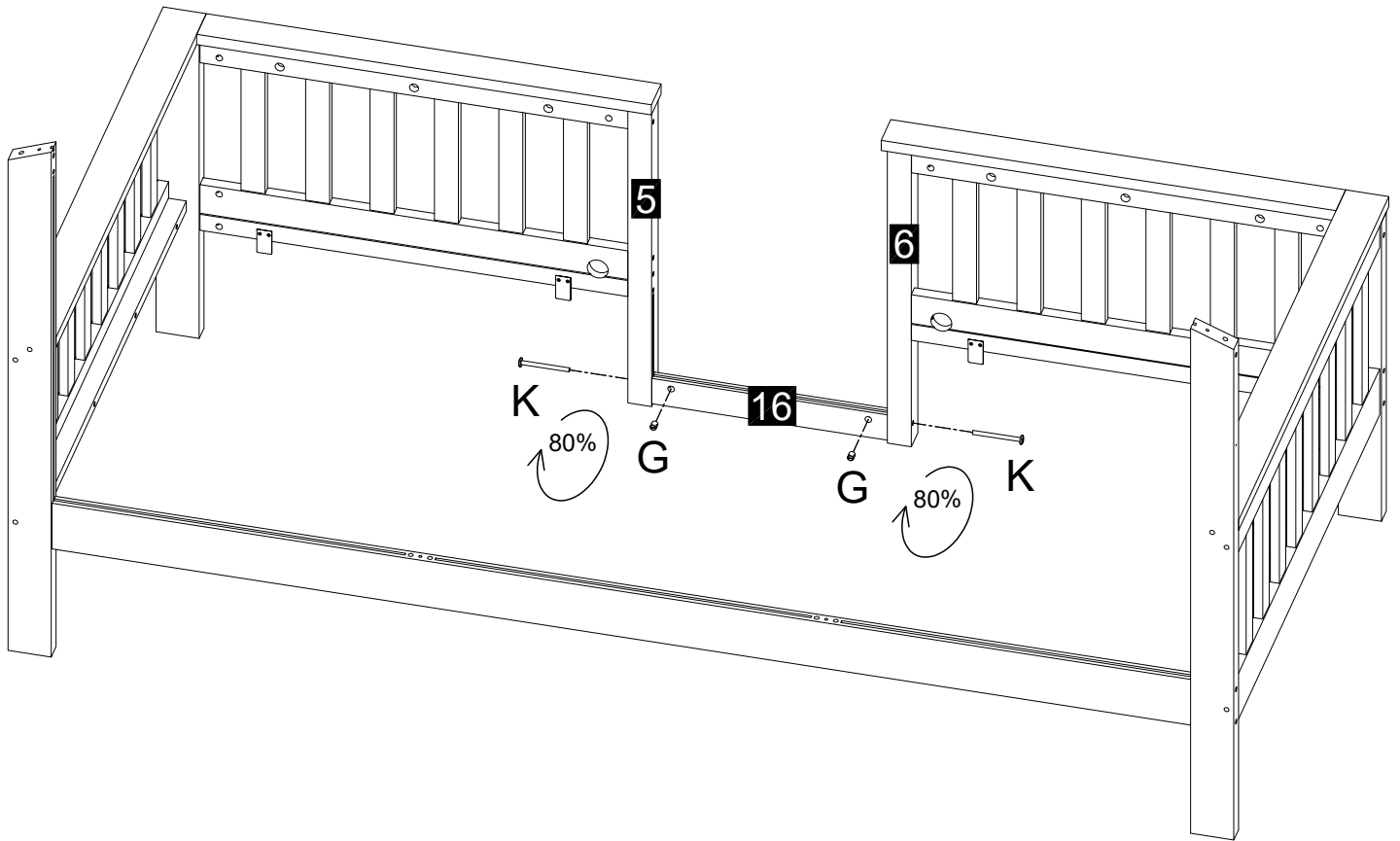

K		M6x80	2
G			2

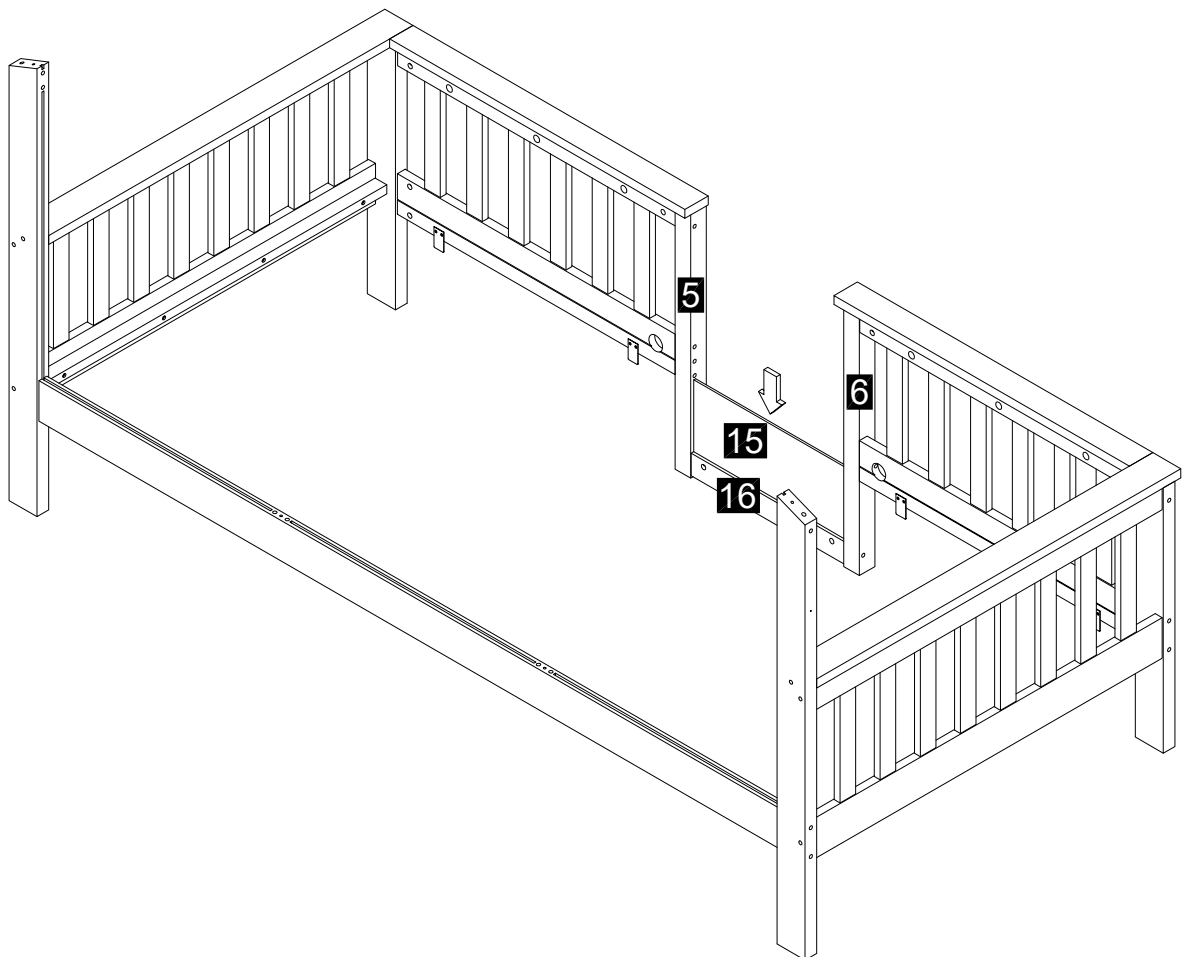

# Schritt 9

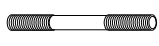

# Schritt 10

L	 120mm	2
M		4
N		2

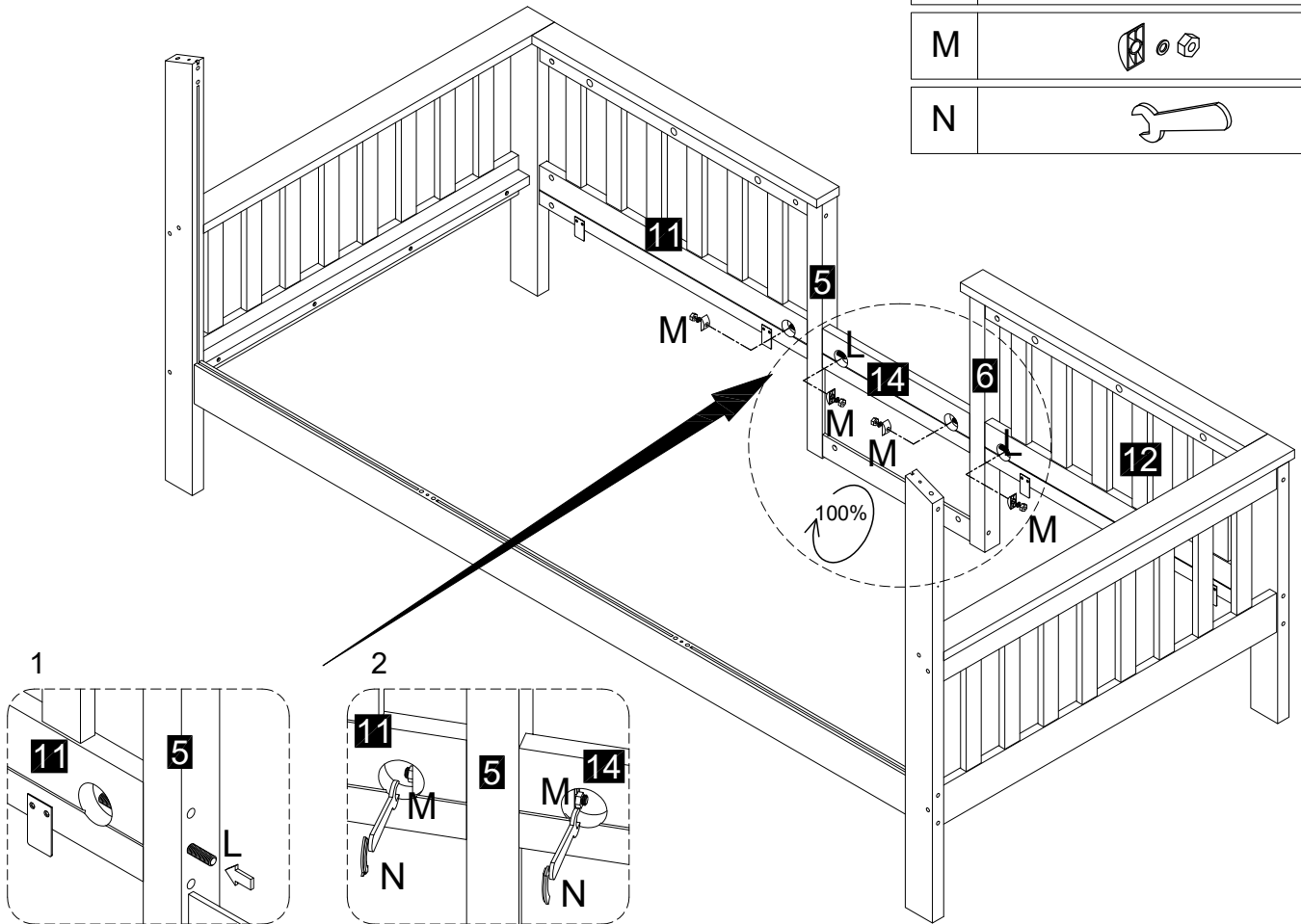

# Schritt 11

E		2
---	---	---

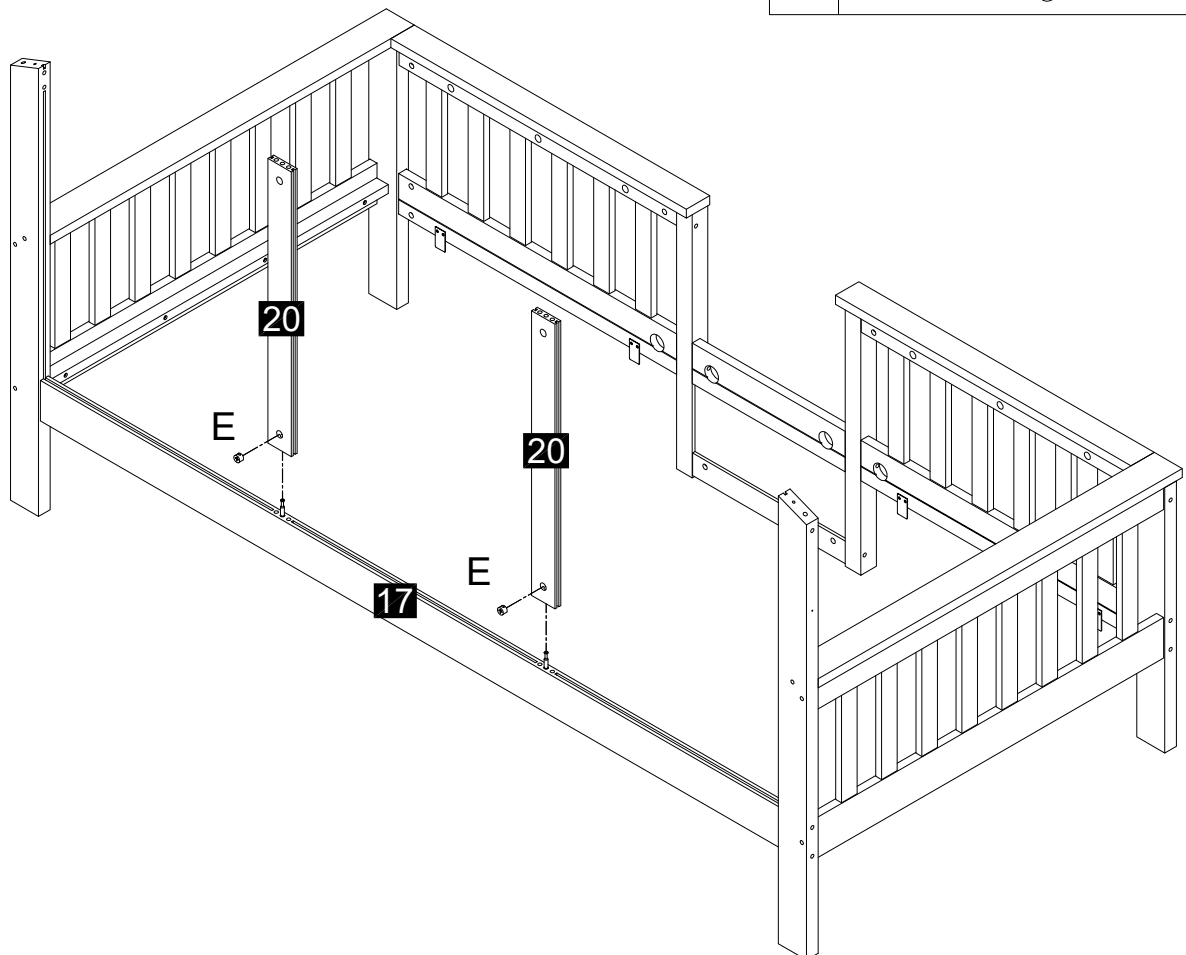

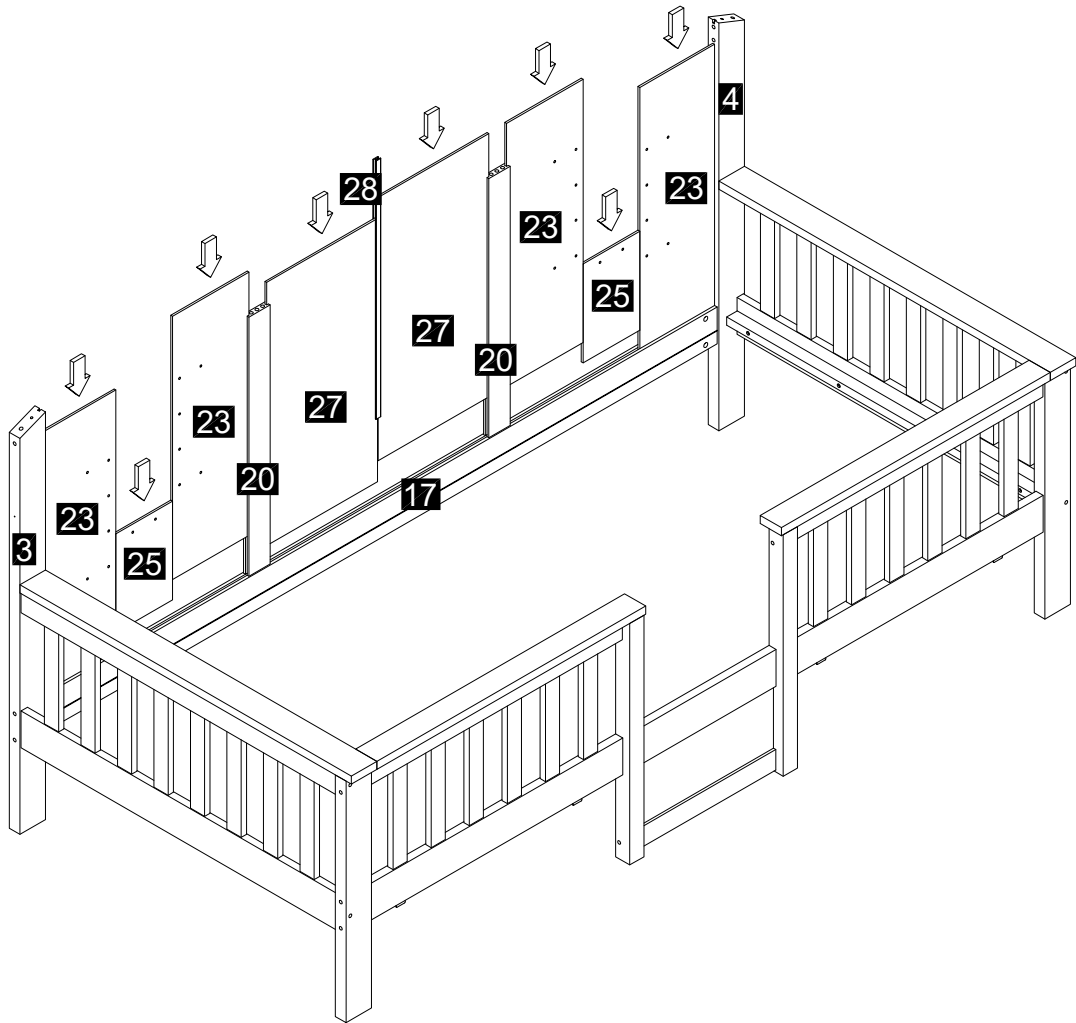

# Schritt 12

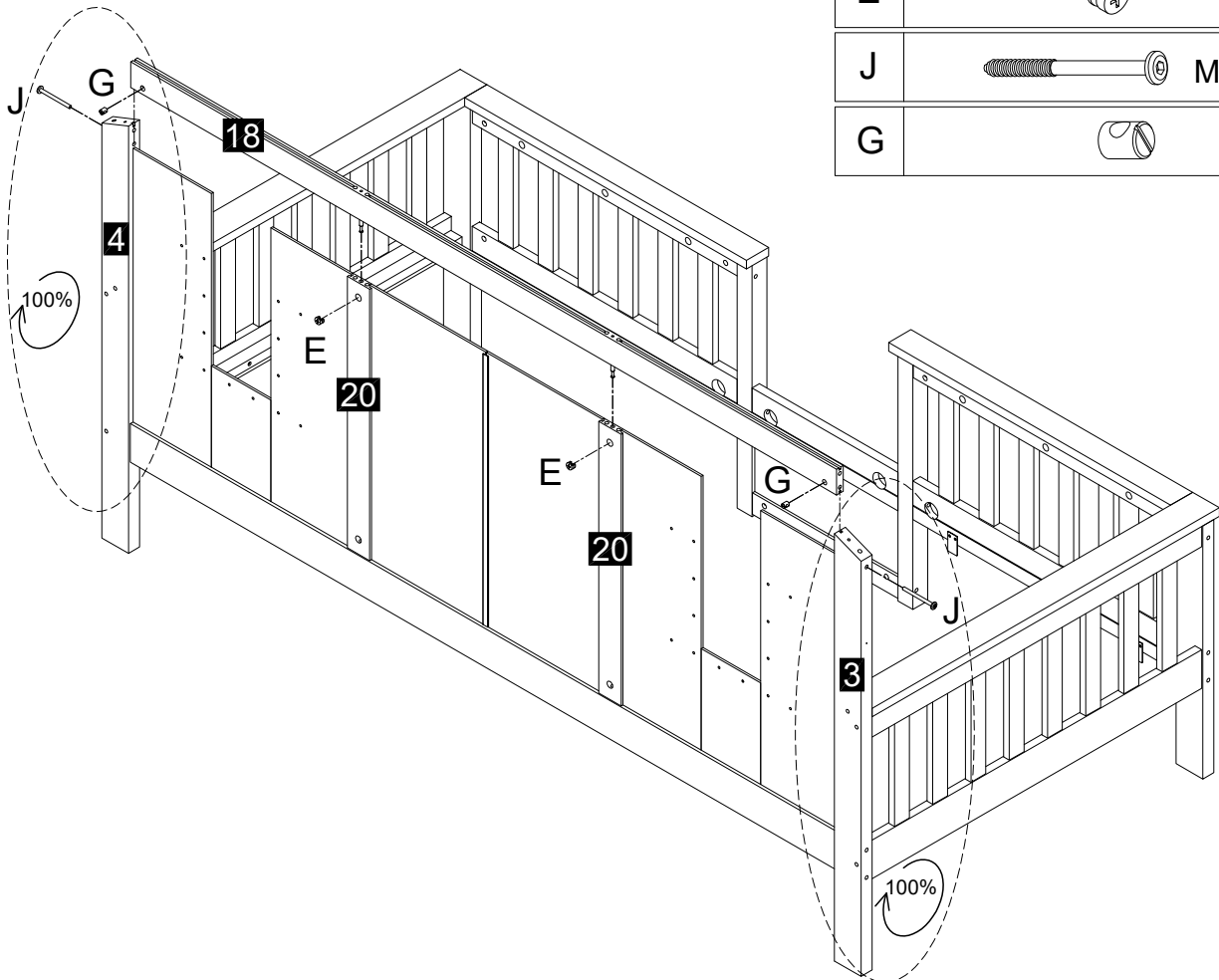

# Schritt 13

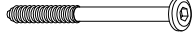

E		2
J	 M6x120	2
G		2

# Schritt 14

E



2

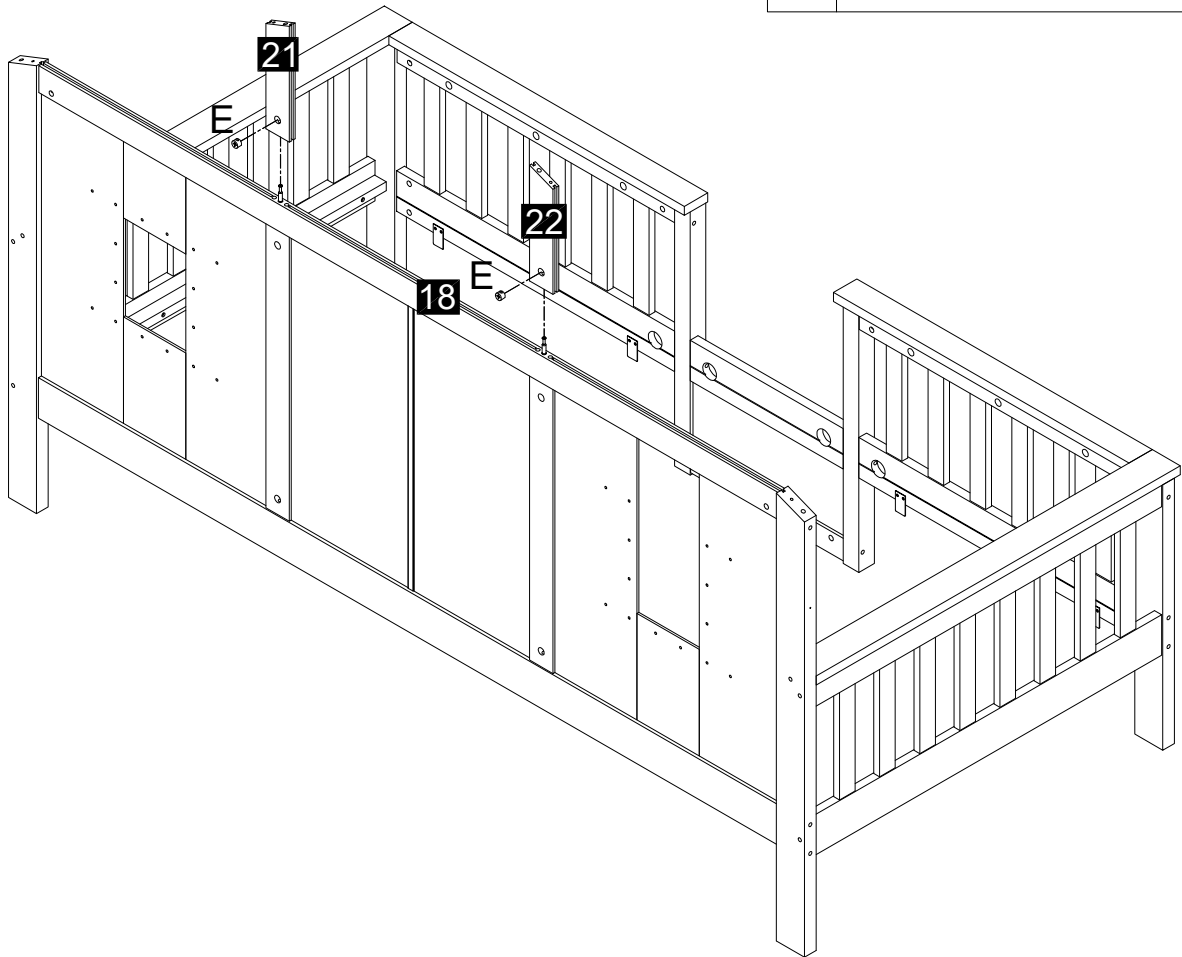

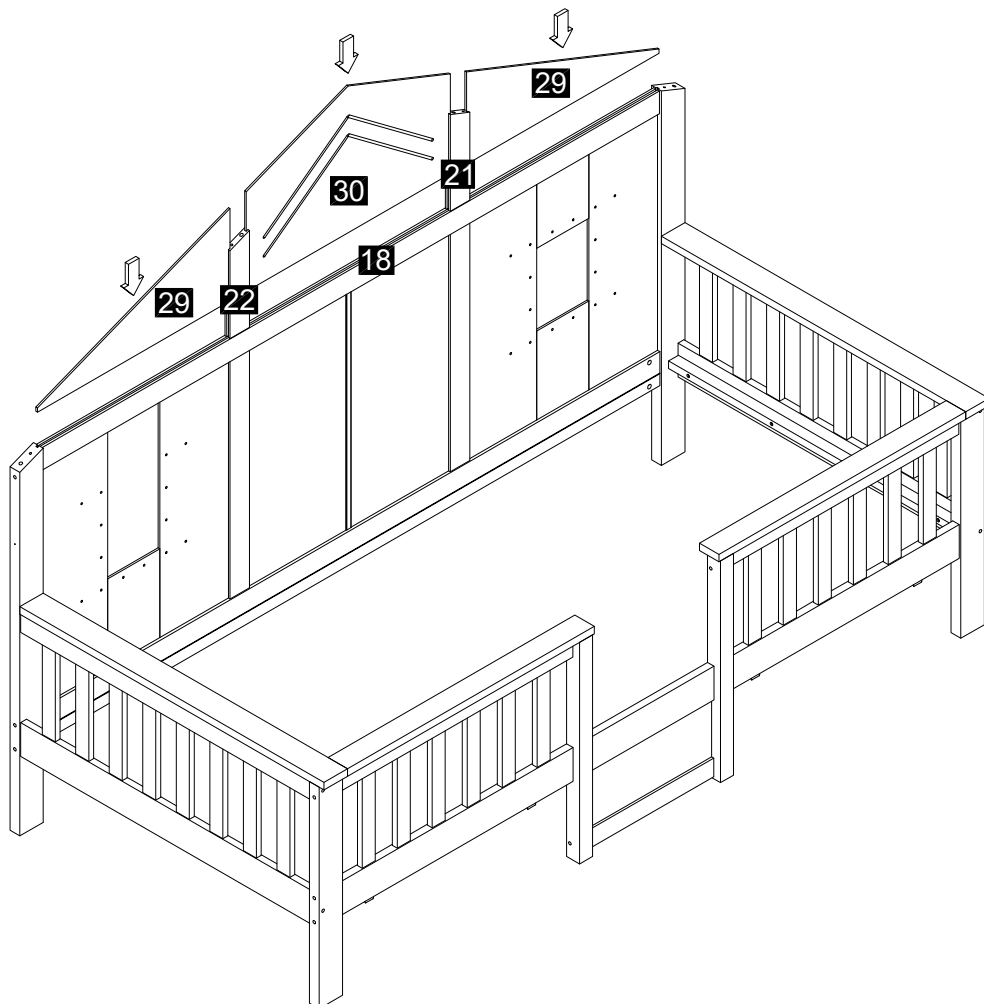

# Schritt 15

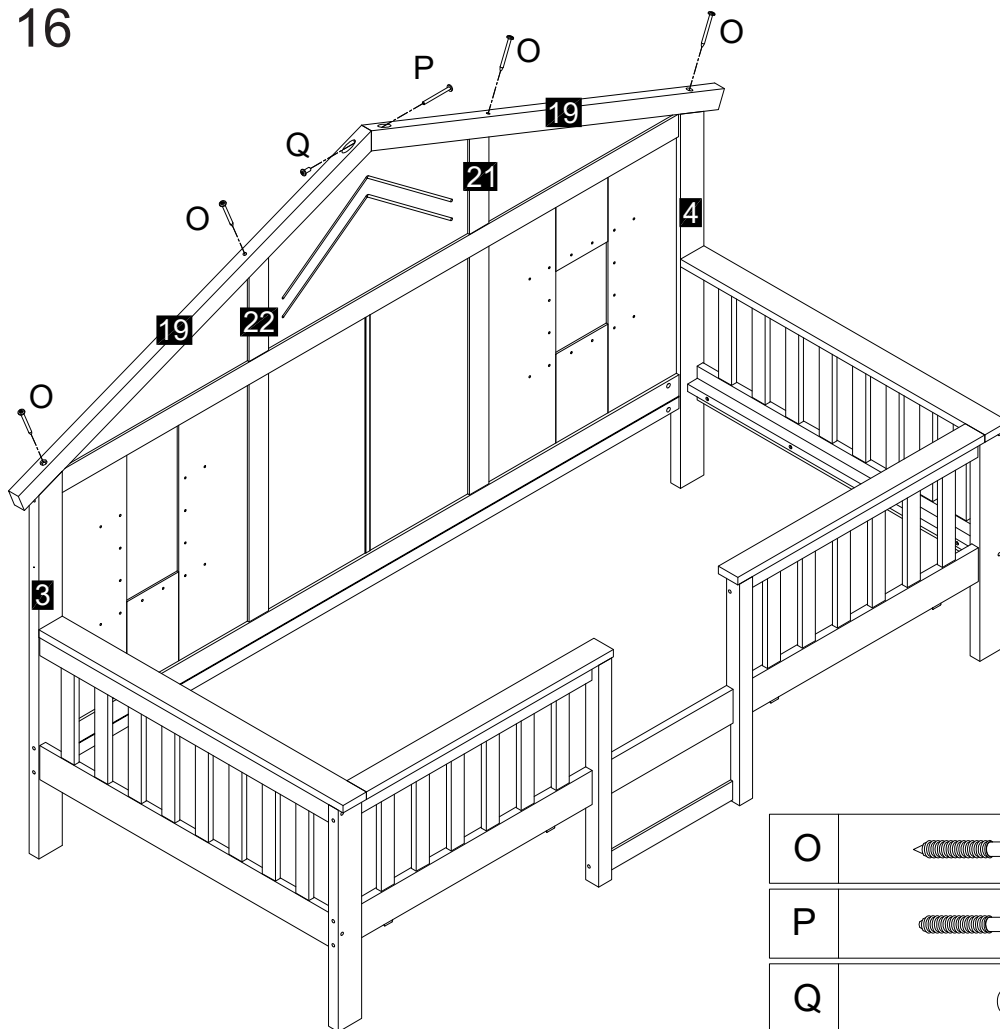

# Schritt 16

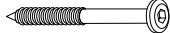

O		Φ6x80	4
P		M6x50	1
Q			1

# Schritt 17

R		Φ4x14	2
---	---	-------	---

**x2**

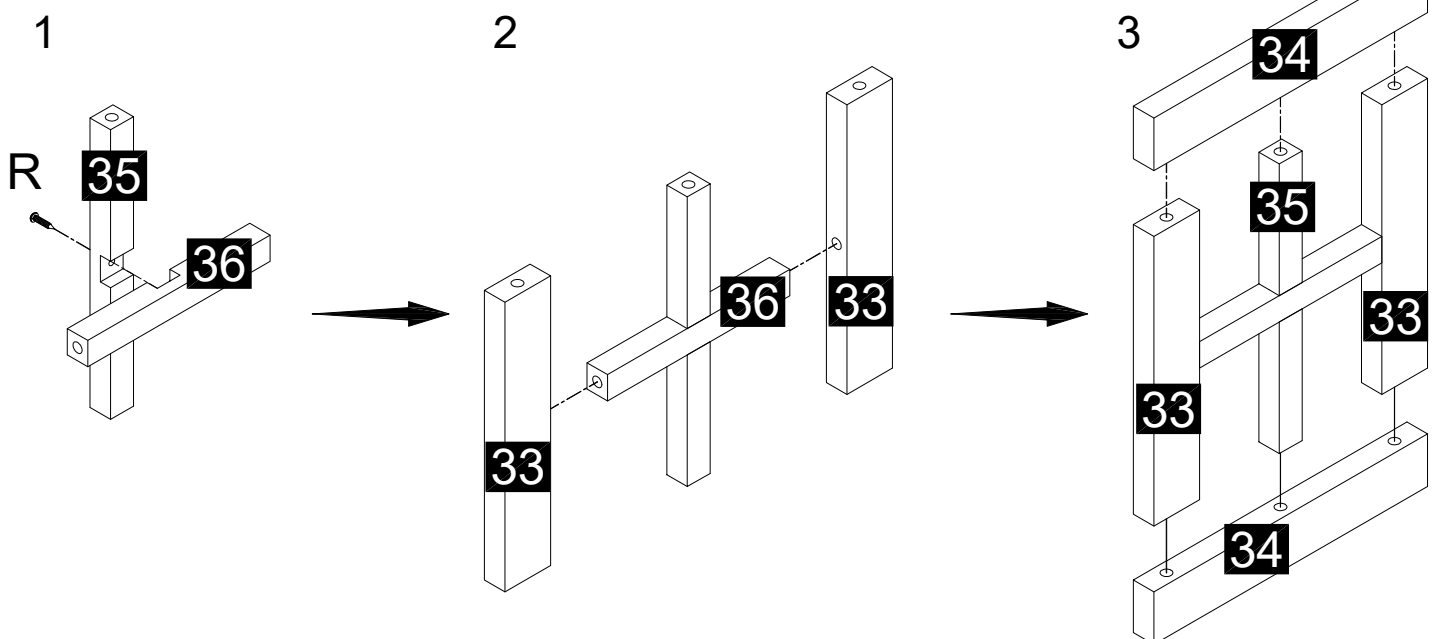

# Schritt 18

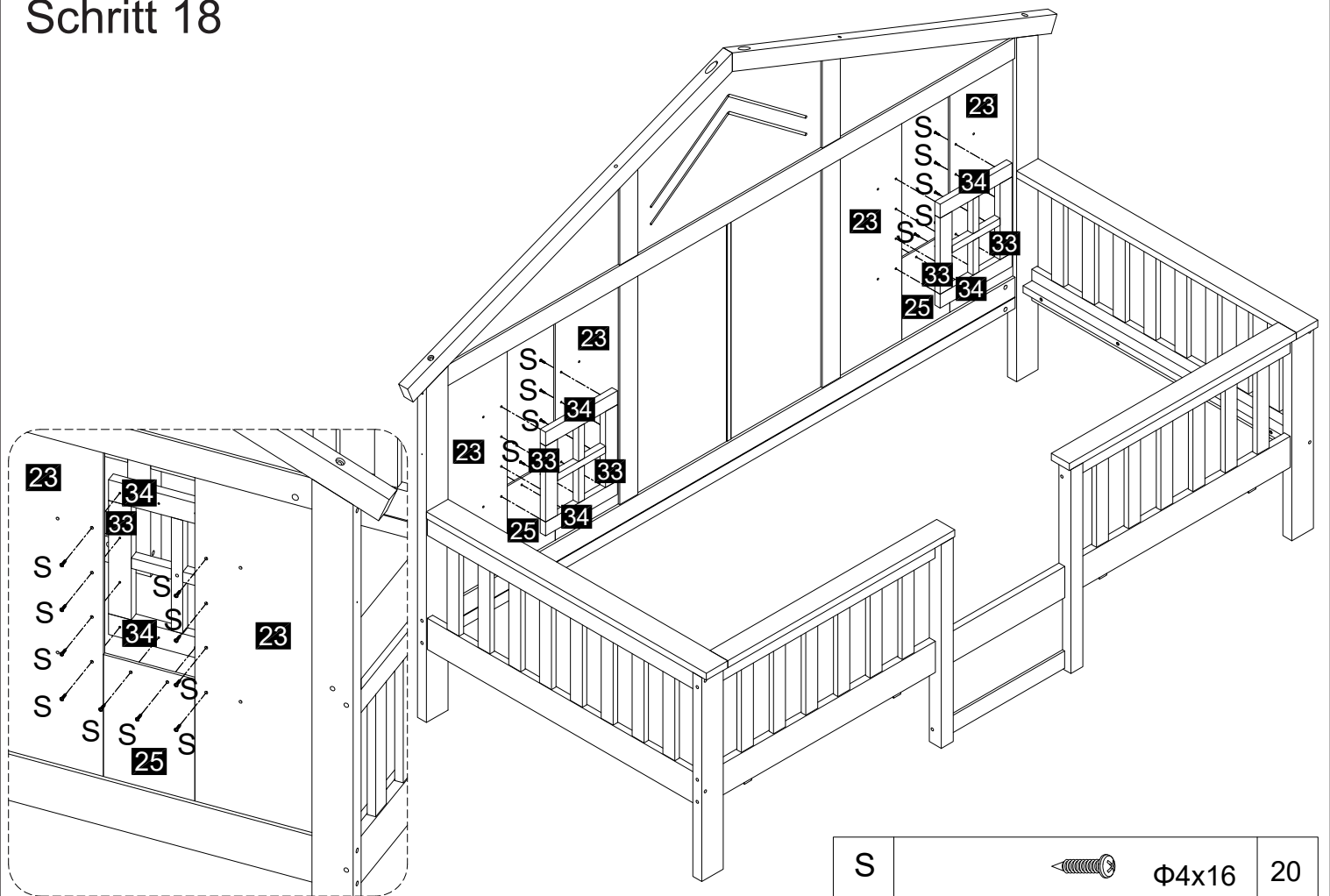

# Schritt 19

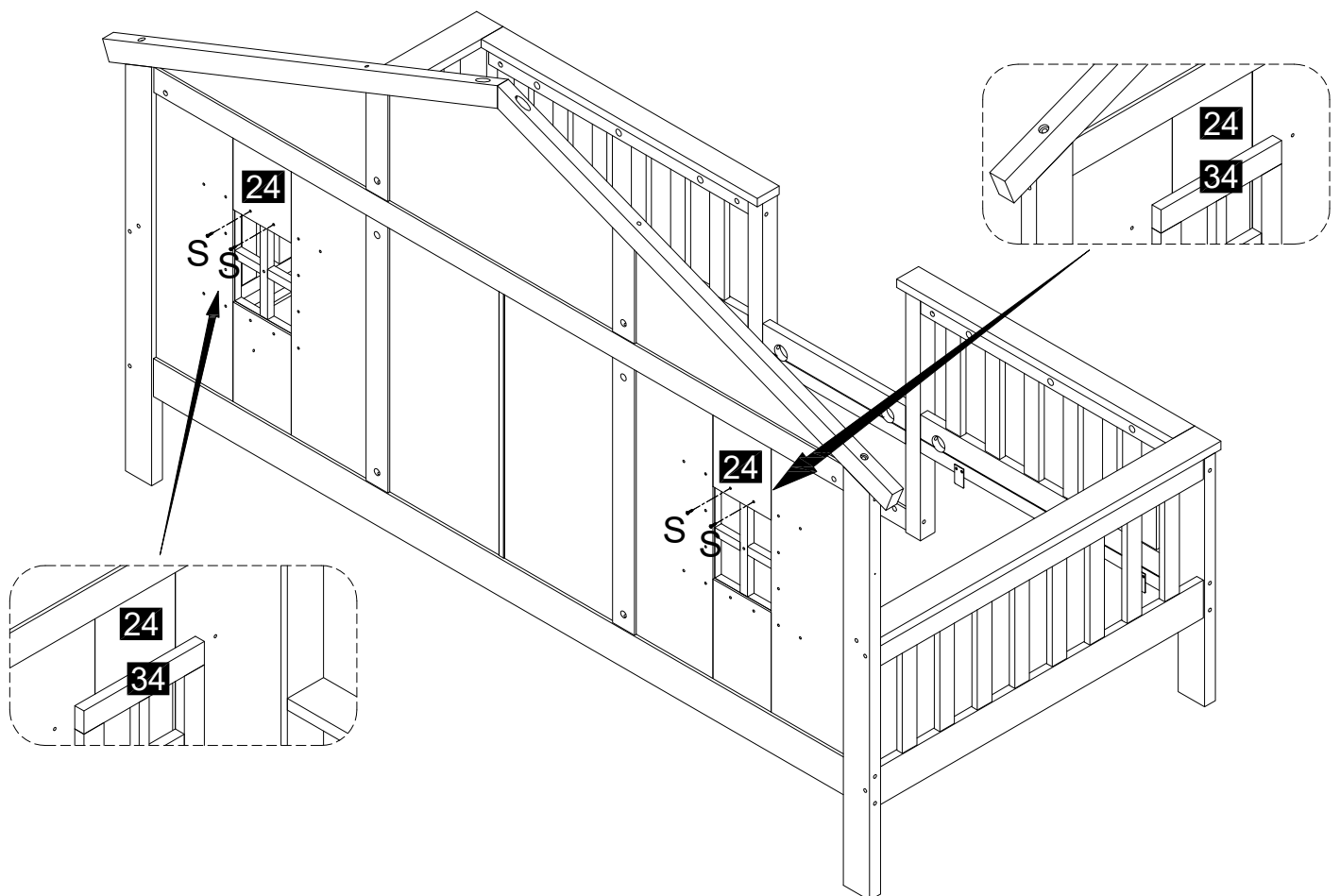

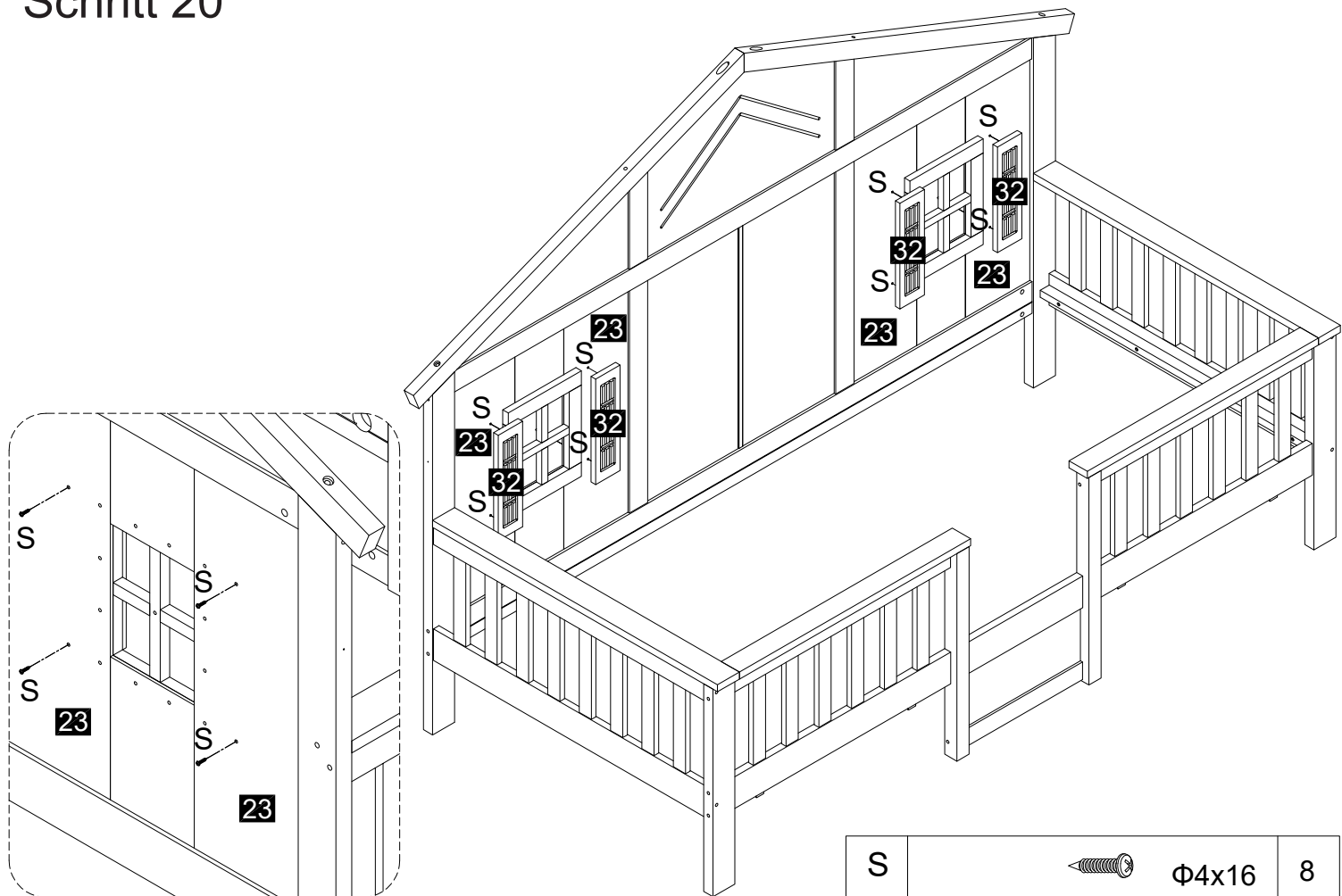

# Schritt 20

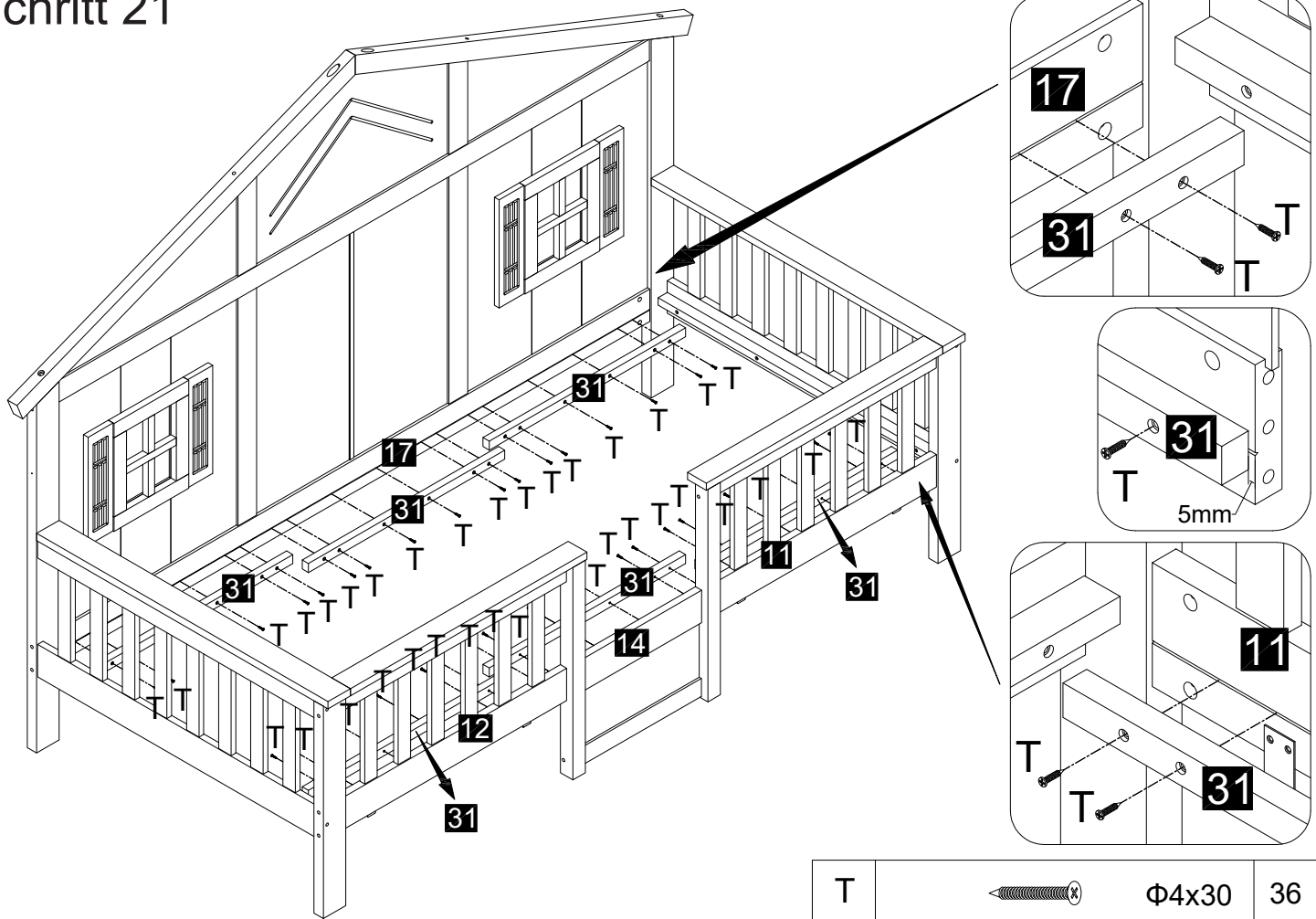

S		Φ4x16	8
---	---	-------	---

# Schritt 21



T		Φ4x30	36
---	---	-------	----

# Schritt 22

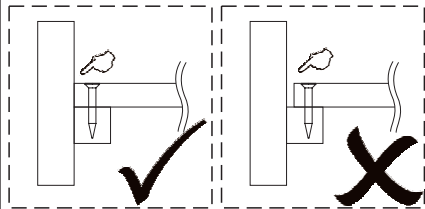
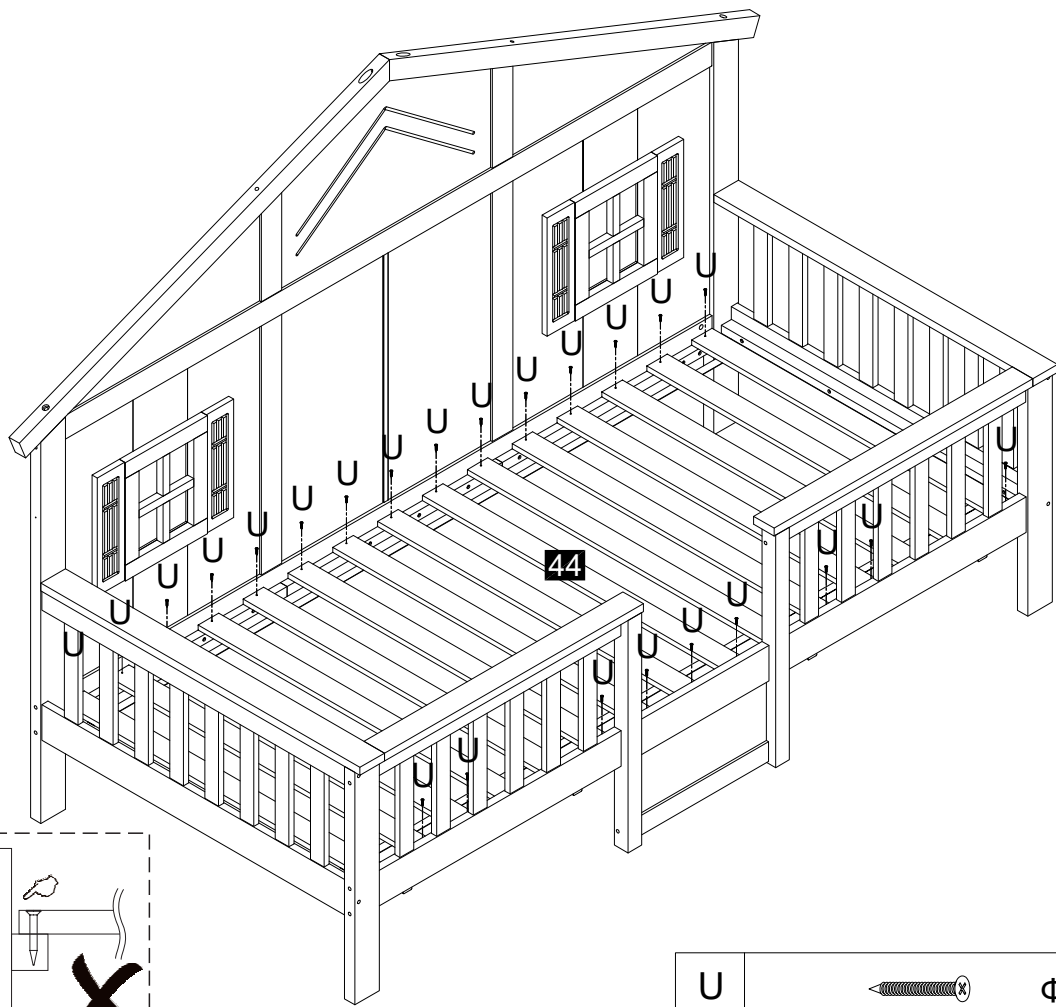

U		Φ3x30	30
---	---	-------	----

# Schritt 23

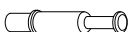
A		Φ8x30	8
D			12

**x2**

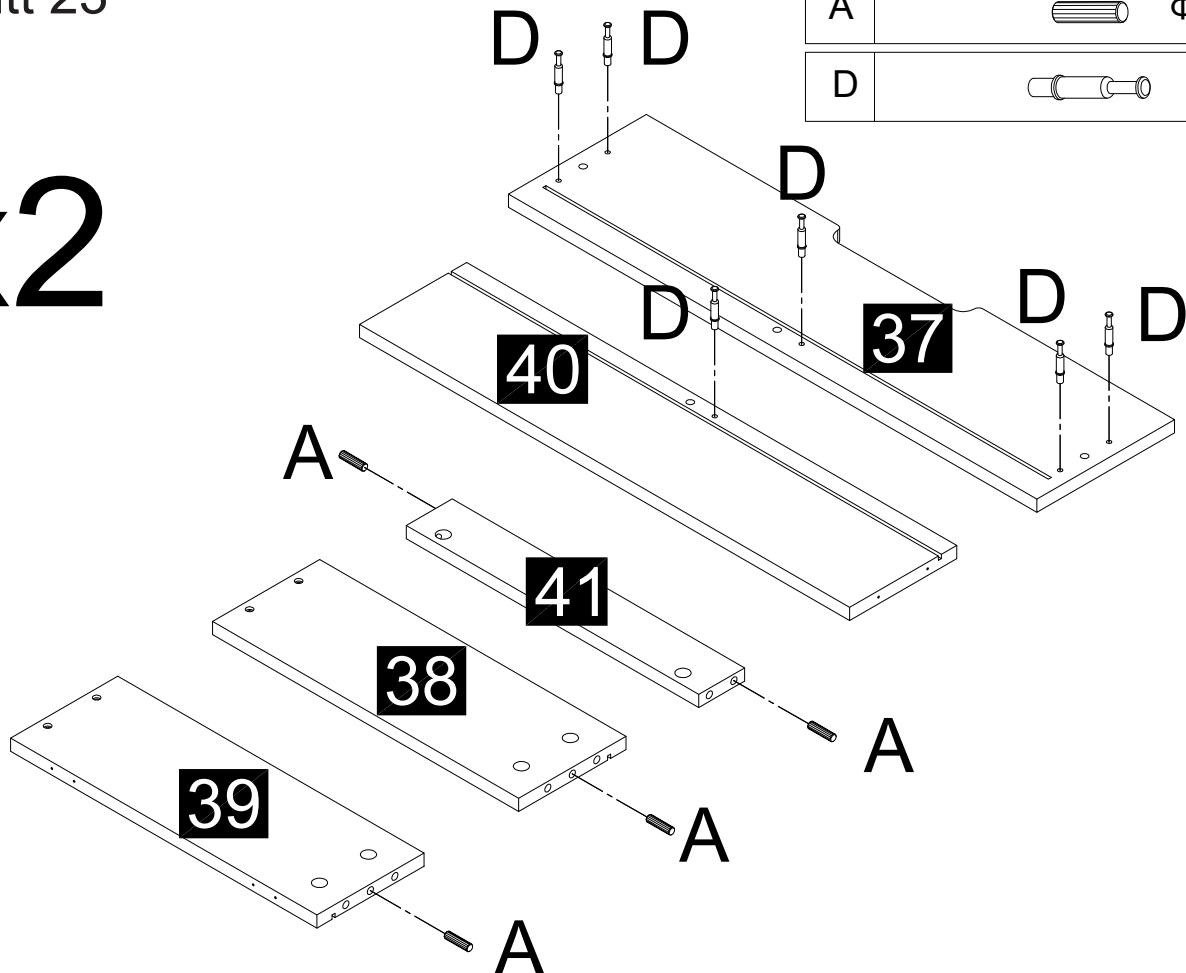

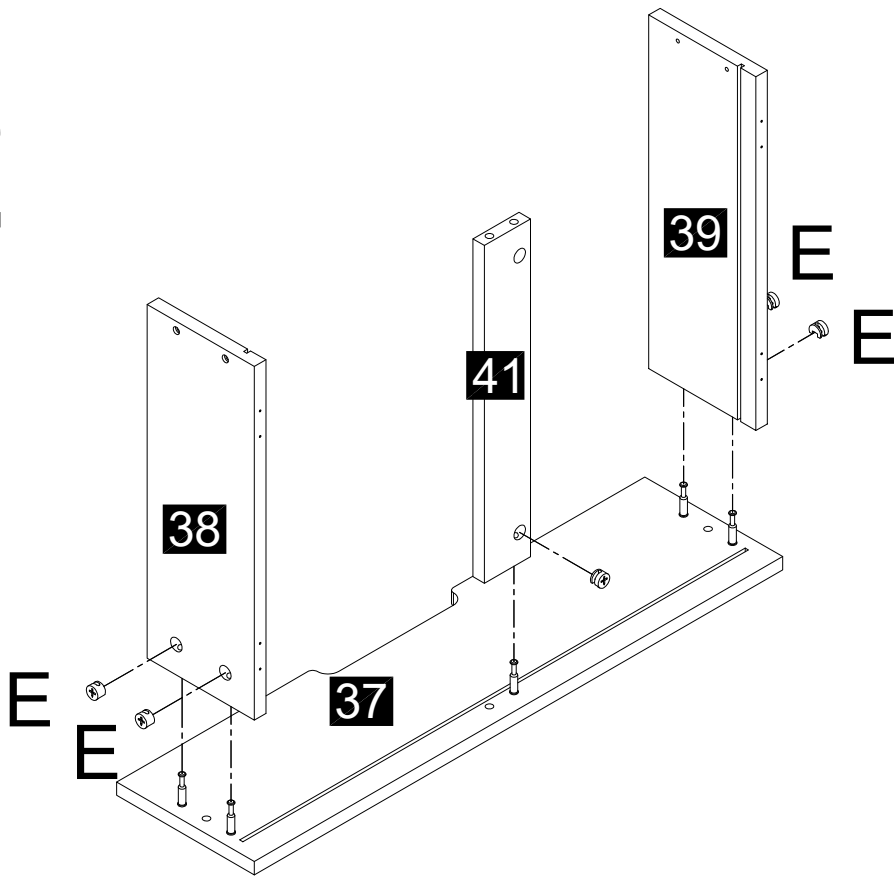

x2

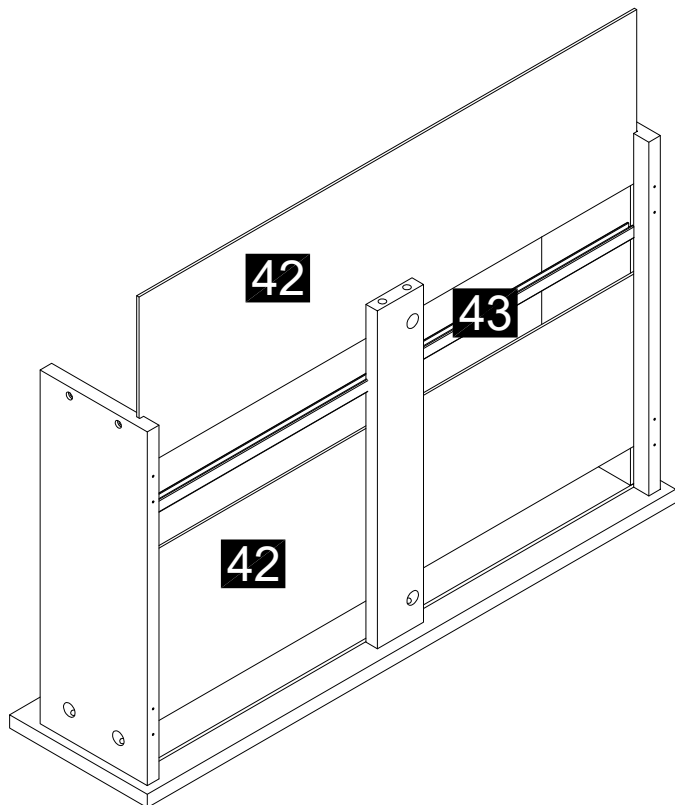

x2





# Schritt 26

E		2
I	 $\Phi 4 \times 40$	8

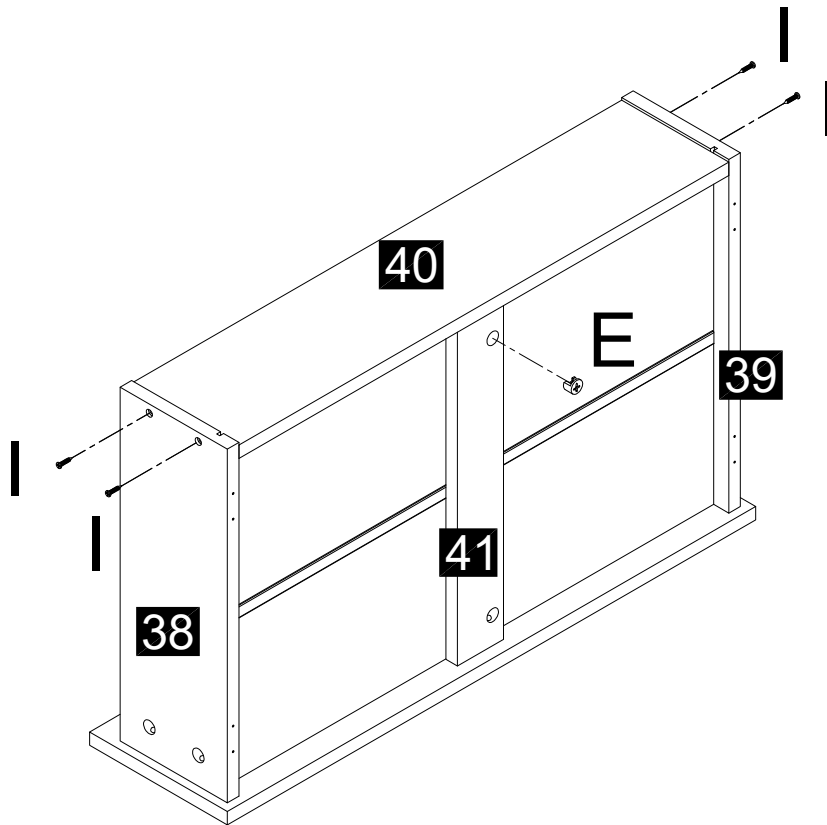
x2



# Schritt 27

C	 $\Phi 3.5 \times 16$	16
V		8

x2

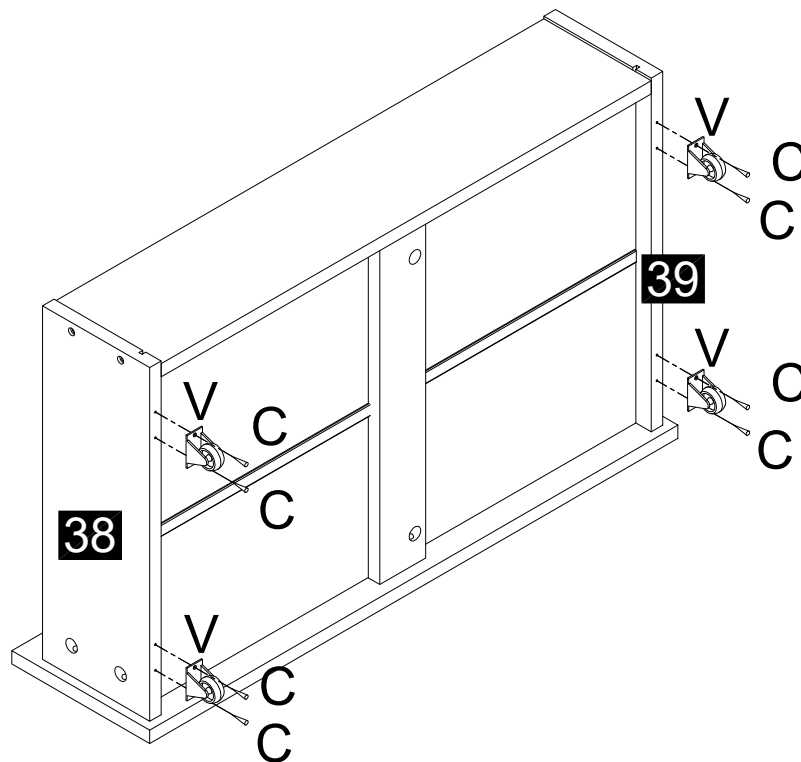

# Schritt 28

W



2

