

# Installation sanleitung Installation Instruction Instruction d'installation

SKU:N879P380611

SKU:N879P380612

SKU:N879P380613

Metall-Hochbett 140x200cm

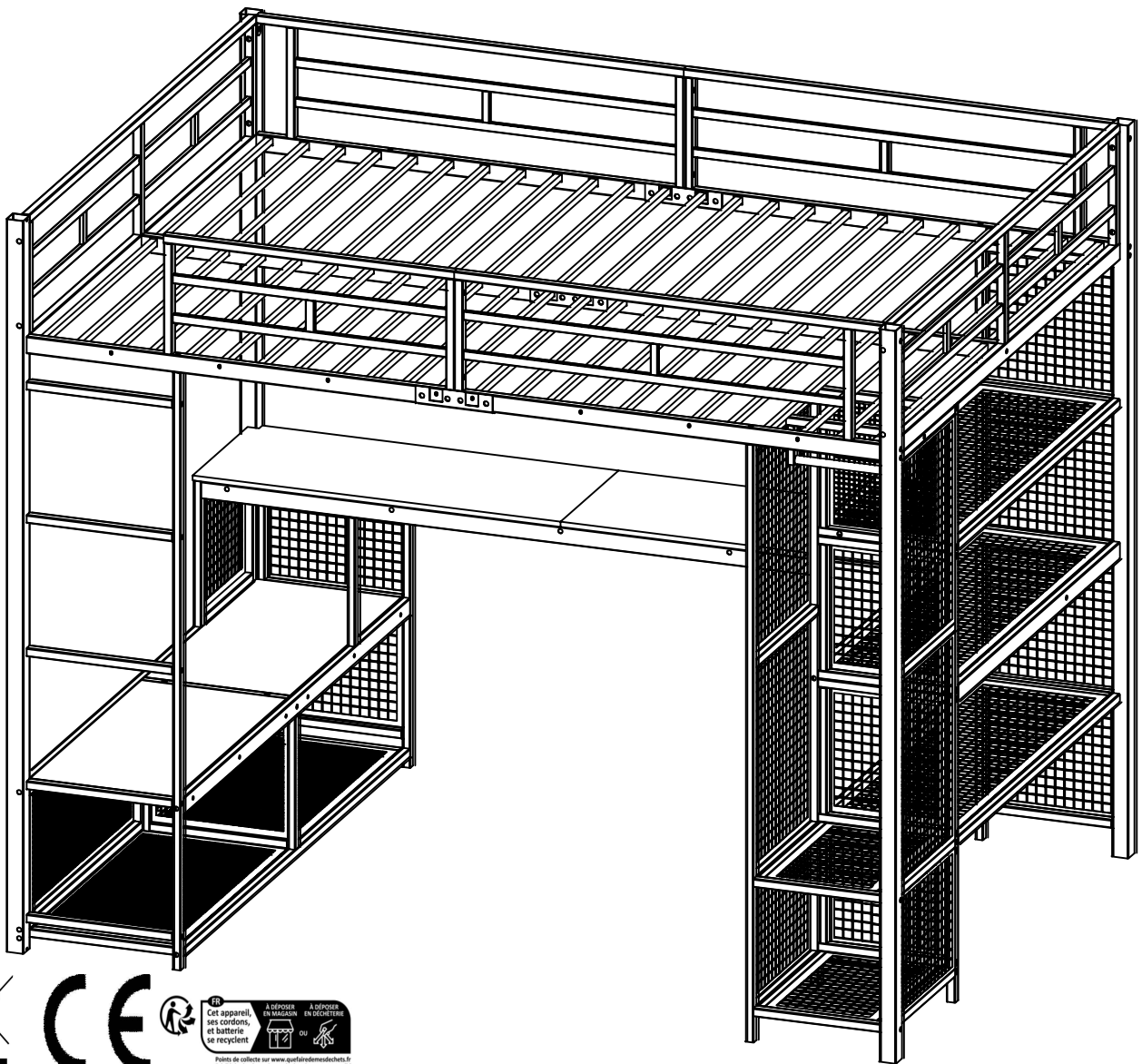

**FR**  
Cet appareil,  
ses câbles  
et batterie,  
se recyclent

**À DÉPOSER  
EN MÉLANGE**

**À DÉPOSER  
EN DÉCHÈTRE**

Points de collecte sur [www.qualifalmedesouches.fr](http://www.qualifalmedesouches.fr)  
Privilégiez la réparation ou le don de votre appareil !

Unser Produkt wird Ihnen in 3 Paketen geliefert. Die Lieferzeiten dieser 3 Pakete können abweichen, bitte haben Sie etwas Geduld und vielen Dank für Ihr Verständnis.

Our product will be delivered to you in 3 packages. The delivery times of these 3 packages may differ, please be patient and thank you for your understanding.

Notre produit vous sera livré en 3 colis. Les délais de livraison de ces 3 colis peuvent différer, soyez patient et merci pour votre compréhension.



**DE:** Vor dem Einbau die Schrauben in die Löcher stecken und festziehen, aber nicht bis 100%, 70% bis 80% anziehen reicht aus. Schließlich, nachdem alle Schrauben installiert sind, ziehen Sie alle Schrauben auf 100%.

Wenn Sie auf diese Probleme stoßen, wie z. B. Fehlausrichtung der Löcher oder Unfähigkeit, bestimmte Teile zu installieren, überprüfen Sie bitte, ob die Schrauben korrekt verwendet werden und passen Sie die Dichtigkeit der Schrauben an.

**UK:** Before installation, insert the screws into the holes and tighten them, but do not tighten them to 100%, 70% to 80% is sufficient. Finally, after all screws are installed, tighten all screws to 100%.

If you encounter these issues, such as if the holes cannot be aligned or some parts cannot be installed, please check if the screws are used correctly and adjust the tightness of the screws.

**FR:** Insérer la vis dans le trou avant la fin de l'assemblage, serrer la vis, mais ne pas serrer à 100%, 70% ~ 80% est correct. Enfin, une fois que toutes les vis sont bien serrées, toutes les vis sont serrées à 100%.

Si vous rencontrez ces problèmes, par exemple si les trous ne sont pas alignés ou si certaines pièces ne peuvent pas être montées, vérifiez que les vis sont utilisées correctement et Ajustez leur serrage.

## English

### IMPORTANT ! KEEP FOR FUTURE REFERENCE : READ CAREFULLY

- To be assembled by an adult. Assembly must be checked by an adult before use
- **WARNING !** Keep all screws, small parts and plastic bags out of the reach of children
- Properly identify all parts before assembling
- Never use your item if any of its parts are broken or missing
- Should any problems arise, please contact our After Sales Service
- Manufacturer's instructions shall be followed at all times
- Care: Clean with a soft, dry cloth. In case of larger stains, carefully rub with a slightly damp, non-abrasive sponge
- Avoid the risk of fire by not placing furniture near sources of ignition or hot items
- Do not jump on the bed

## Deutsch

### WICHTIG ! ZUM SPÄTEREN NACHSCHLAGEN AUFBEWAHREN: SORGFÄLTIG LESEN

- Muss von einem Erwachsenen zusammengebaut werden. Der Zusammenbau muss vor dem Gebrauch von einem Erwachsenen überprüft werden
- **WARNUNG!** Bewahren Sie alle Schrauben, Kleinteile und Plastikbeutel außerhalb der Reichweite von Kindern auf
- Kennzeichnen Sie vor dem Zusammenbau alle Teile richtig
- Benutzen Sie Ihren Artikel niemals, wenn Teile gebrochen sind oder fehlen
- Sollten Probleme auftreten, wenden Sie sich bitte an unseren Kundendienst
- Die Anweisungen des Herstellers sind stets zu befolgen
- Pflege: Mit einem weichen, trockenen Tuch reinigen. Bei größeren Flecken vorsichtig mit einem leicht feuchten, nicht scheuernden Schwamm abreiben. nicht scheuernden Schwamm
- Vermeiden Sie die Gefahr eines Brandes, indem Sie die Möbel nicht in der Nähe von Zündquellen oder heißen Gegenständen aufstellen
- Nicht auf das Bett springen

## Français

### IMPORTANT ! CONSERVER POUR RÉFÉRENCE ULTÉRIEURE : LIRE ATTENTIVEMENT

- Le montage doit être effectué par un adulte. Le montage doit être vérifié par un adulte avant Utilisation
- **ATTENTION !** Tenir les vis, les petites pièces et les sachets en plastique hors de portée des enfants
- Identifiez correctement toutes les pièces avant de les assembler
- N'utilisez jamais votre article si l'une de ses pièces est cassée ou manquante
- En cas de problème, veuillez contacter notre service après-vente
- Les instructions du fabricant doivent être respectées à tout moment
- Entretien : nettoyer avec un chiffon doux et sec. En cas de taches plus importantes, frotter soigneusement avec une éponge non abrasive légèrement humide. légèrement humide et non Abrasive
- Évitez les risques d'incendie en ne plaçant pas les meubles à proximité de sources d'inflammation ou d'objets chauds
- Ne pas sauter sur le lit

## WARNING

---

- a) This bed is not suitable for children under six years due to the risk of injury from falls;
- b) Bunk beds / high beds can present a serious risk of injury from strangulation if not used correctly. Never attach or hang items to any part of the bunk bed / high bed that are not designed to be used with the bed, for example, but not limited to ropes, strings, cords, hooks, belts and bags";
- c) Children can become trapped between the bed and the wall, a roof pitch, the ceiling, adjoining pieces of furniture (e.g.cupboards) and the like. To avoid risk of serious injury the distance between the top safety barrier and the adjoining structure must not exceed 75 mm or must be more than 230 mm;
- d) Do not use this bunk bed /high bed if any structural part is broken or missing;
- e) Always ensure the platform and the ladder / stairs are permanently attached to this bunk bed before use
- f) This product must be attached to a wall or building structure; Always follow the manufacturer's instructions;
- g) The recommended size (78.7"L\*55.1"W\*3.9"TH) of the mattress(es);The maximum thickness of the mattress 3.9". A statement that ventilation of the room is necessary in order to keep
- h) the humidity low and to prevent mould in and around the bed; Joining devices should always be tightened properly and regularly verified. Tighten if necessary.







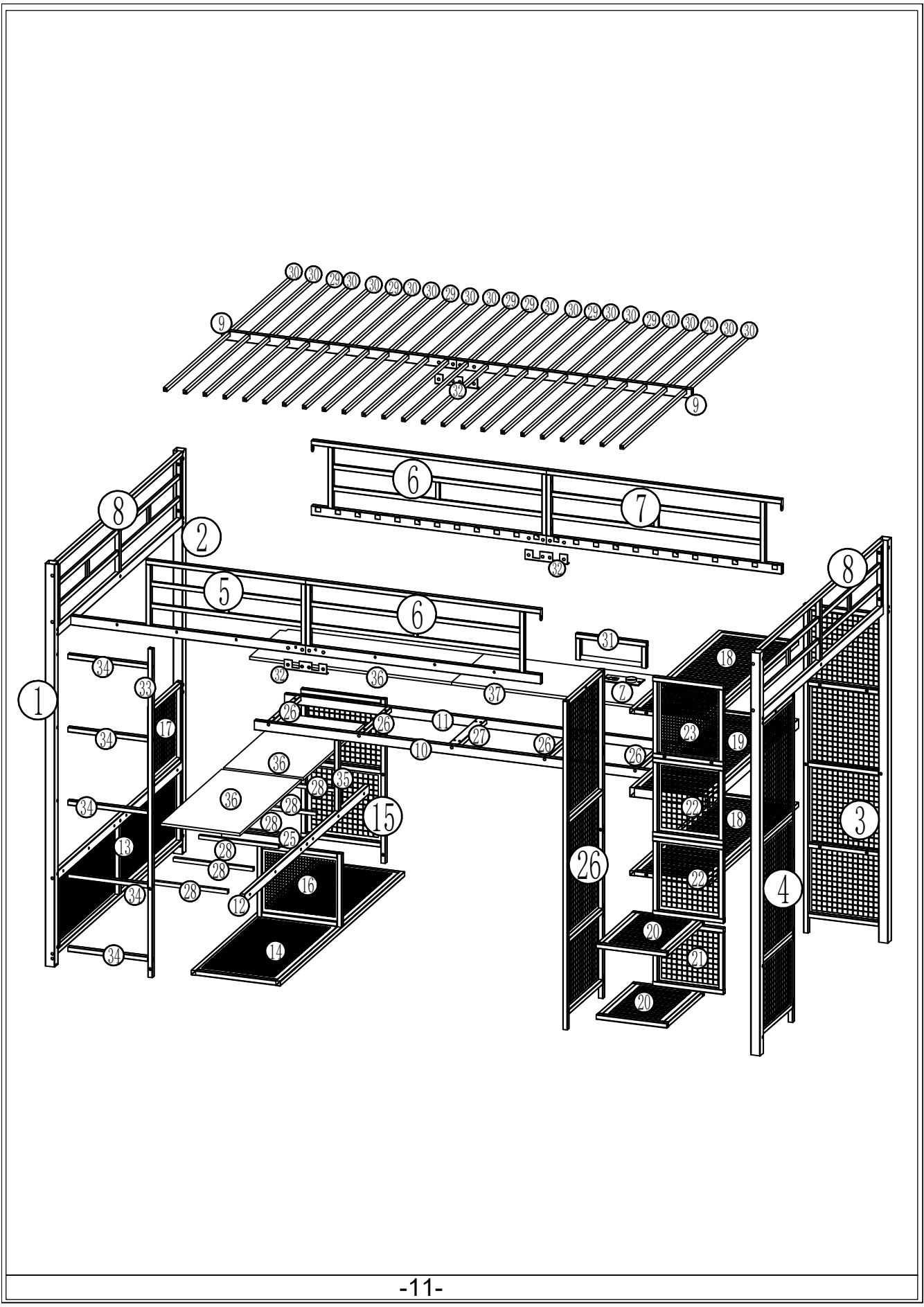



## WARNUNG

---

- a) Von der Benutzung dieses Bettes durch Kinder unter sechs Jahren wird abgeraten – Sturz- und Verletzungsgefahr!
- b) Etagenbetten / Hochbetten bergen bei unsachgemäßer Nutzung ein ernsthaftes Strangulationsrisiko. An keinem Teil des Bettes dürfen Gegenstände befestigt oder aufgehängt werden, die nicht dafür vorgesehen sind – einschließlich, aber nicht beschränkt auf Seile, Schnüre, Kordeln, Haken, Gürtel oder Taschen.
- c) Kinder können zwischen dem Bett und der Wand, einer Dachschräge, der Decke, angrenzenden Möbelstücken (z. B. Schränken) oder ähnlichen Strukturen eingeklemmt werden. Um das Risiko schwerer Verletzungen zu vermeiden, darf der Abstand zwischen der oberen Schutzbarriere und der angrenzenden Struktur entweder 75 mm nicht überschreiten oder muss mehr als 230 mm betragen.
- d) Dieses Etagenbett/Hochbett darf nicht verwendet werden, wenn irgendein strukturelles Teil beschädigt oder fehlt.
- e) Stellen Sie vor jeder Nutzung sicher, dass die Plattform sowie die Leiter/Treppe dauerhaft mit diesem Etagenbett/Hochbett verbunden sind.
- f) Dieses Produkt muss an einer Wand oder tragenden Gebäudestruktur befestigt werden. Befolgen Sie stets die Montageanleitung des Herstellers.
- g) Empfohlene Matratzenabmessungen: 200 cm (Länge) × 140 cm (Breite) × 10 cm (Dicke/Stärke); Zulässige Maximaldicke der Matratze: 10 cm.Ein Hinweis, dass eine regelmäßige Belüftung des Schlafzimmers notwendig ist, um die Matratzenhygiene zu erhalten.
- h) Maintaining Low Humidity & Preventing Mold Around the Bed.Verbindungsteile sind stets fachgerecht anzuziehen und in regelmäßigen Abständen zu kontrollieren. Gegebenenfalls nachspannen.

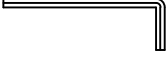

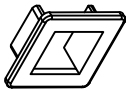
# Parts List For : N879P380613

 A M4*10mm 2pcs	 B M8*15mm 14pcs	 C M8*35mm 71pcs	 D M8*55mm 39pcs
 E M6*25mm 28pcs	 F M8*15mm 28pcs	 R M4*25mm 24pcs	 L
 M	 Z 1pcs	 K 48pcs	 X M6*30mm 12pcs

# Parts List For : N879P380611

①

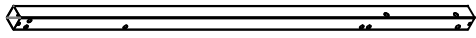

1pc

②

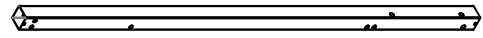

1pc

③

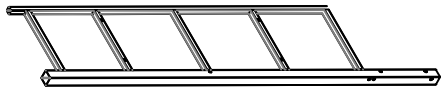

1pc

④

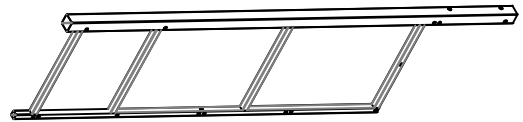

1pc

⑨



2pc

⑩



1pc

⑫



1pc

⑱



1pc

⑳

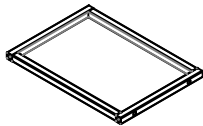

1pc

㉔







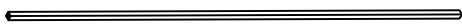

1pc

③①

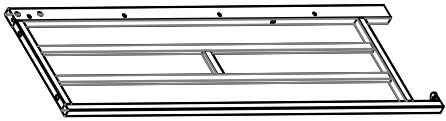
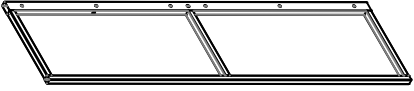
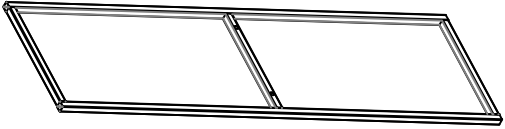
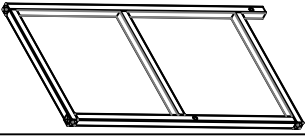
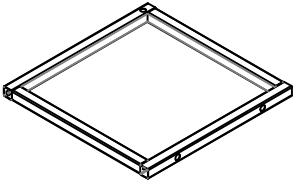

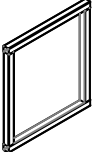
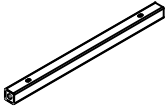

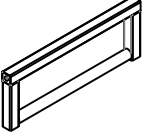

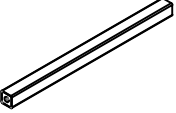
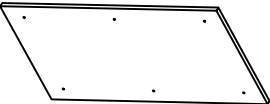
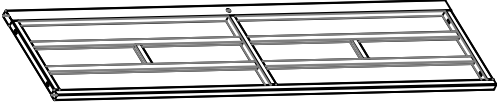

10pc

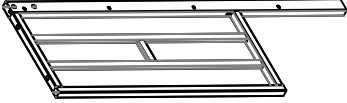
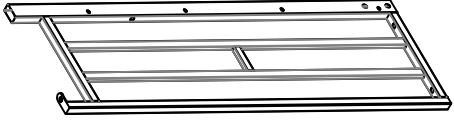
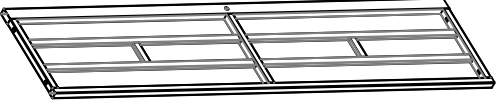
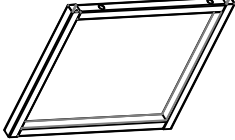

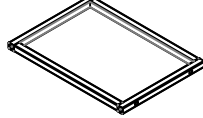
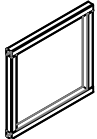
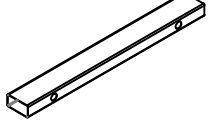
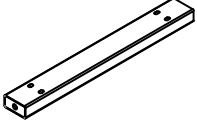

# Parts List For : N879P380612

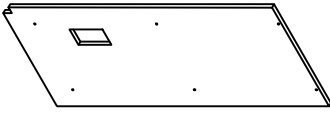
<p>⑦</p>  <p>1pc</p>	<p>⑬</p>  <p>1pc</p>
<p>⑭</p>  <p>1pc</p>	<p>⑮</p>  <p>1pc</p>
<p>⑰</p>  <p>1pc</p>	<p>⑱</p>  <p>1pc</p>
<p>⑳</p>  <p>2pc</p>	<p>㉓</p>  <p>4pc</p>
<p>㉔</p>  <p>6pc</p>	<p>㉖</p>  <p>2pc</p>
<p>㉗</p>  <p>1pc</p>	<p>㉙</p>  <p>5pc</p>
<p>㉚</p>  <p>1pc</p>	<p>㉛</p>  <p>2pc</p>
<p>⑧</p>  <p>1pc</p>	

# Parts List For : N879P380613

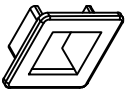
<p>⑤</p>  <p>1pc</p>	<p>⑥</p>  <p>2pc</p>
<p>⑧</p>  <p>1pc</p>	<p>⑬</p>  <p>1pc</p>
<p>⑱</p>  <p>1pc</p>	<p>⑳</p>  <p>1pc</p>
<p>㉑</p>  <p>1pc</p>	<p>㉕</p>  <p>1pc</p>
<p>㉖</p>  <p>1pc</p>	<p>㉙</p>  <p>8pc</p>
<p>⑳</p>  <p>4pc</p>	<p>㉛</p>  <p>1pc</p>
<p>㉞</p>  <p>1pc</p>	

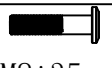

1

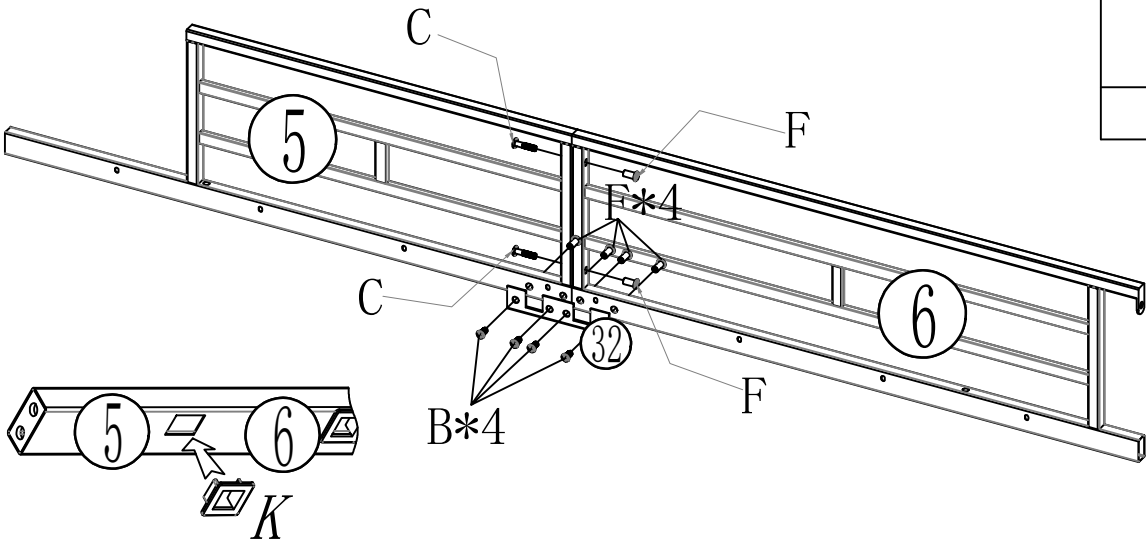
			
K × 24PCS	F × 6PCS	B × 4PCS	L
			
			C × 8PCS

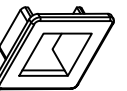

Part One

2

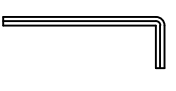
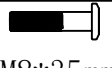
			
K × 24PCS	F × 6PCS	B × 4PCS	L
			
			C × 8PCS

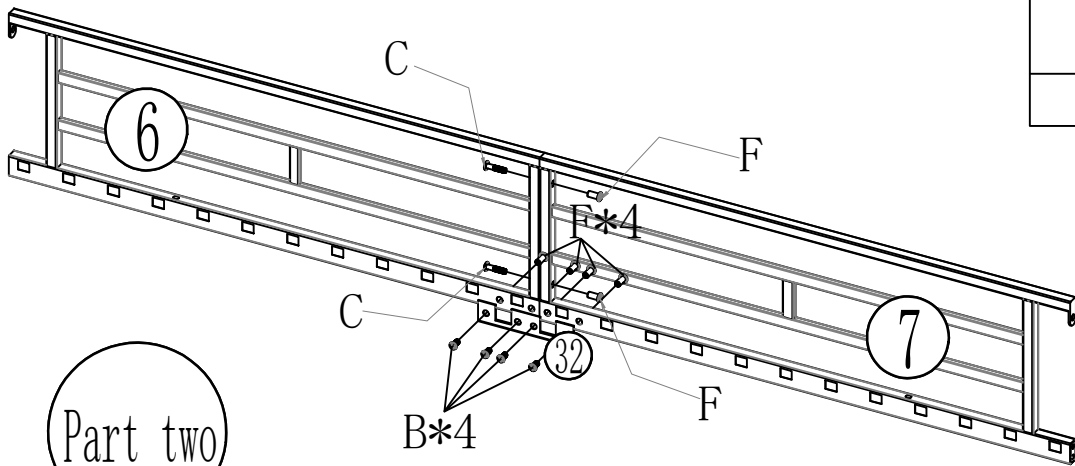

Part two

3

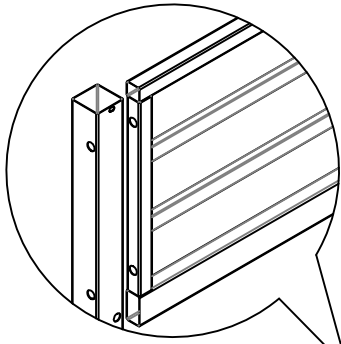

Note the installation direction of this hole. **Attention**

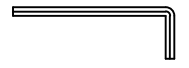
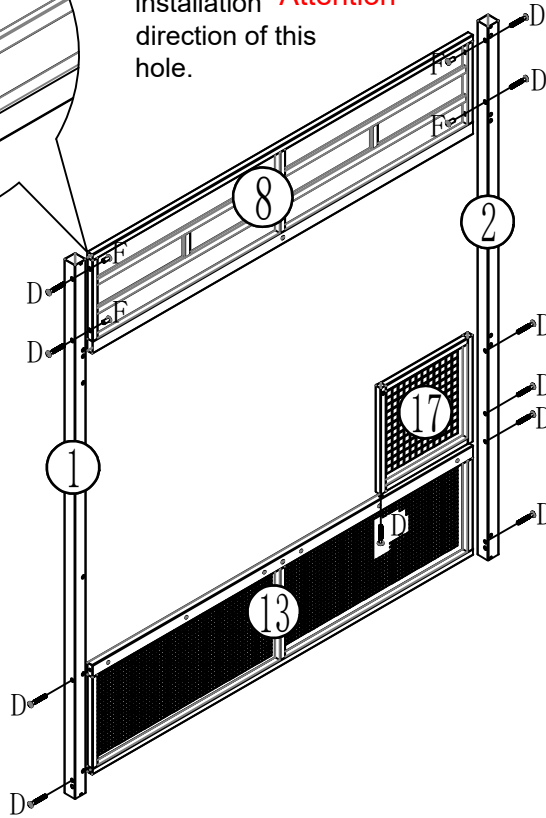

L



M8\*55mm

D × 11PCS



M8\*15mm

F × 4PCS

4

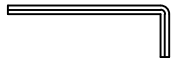
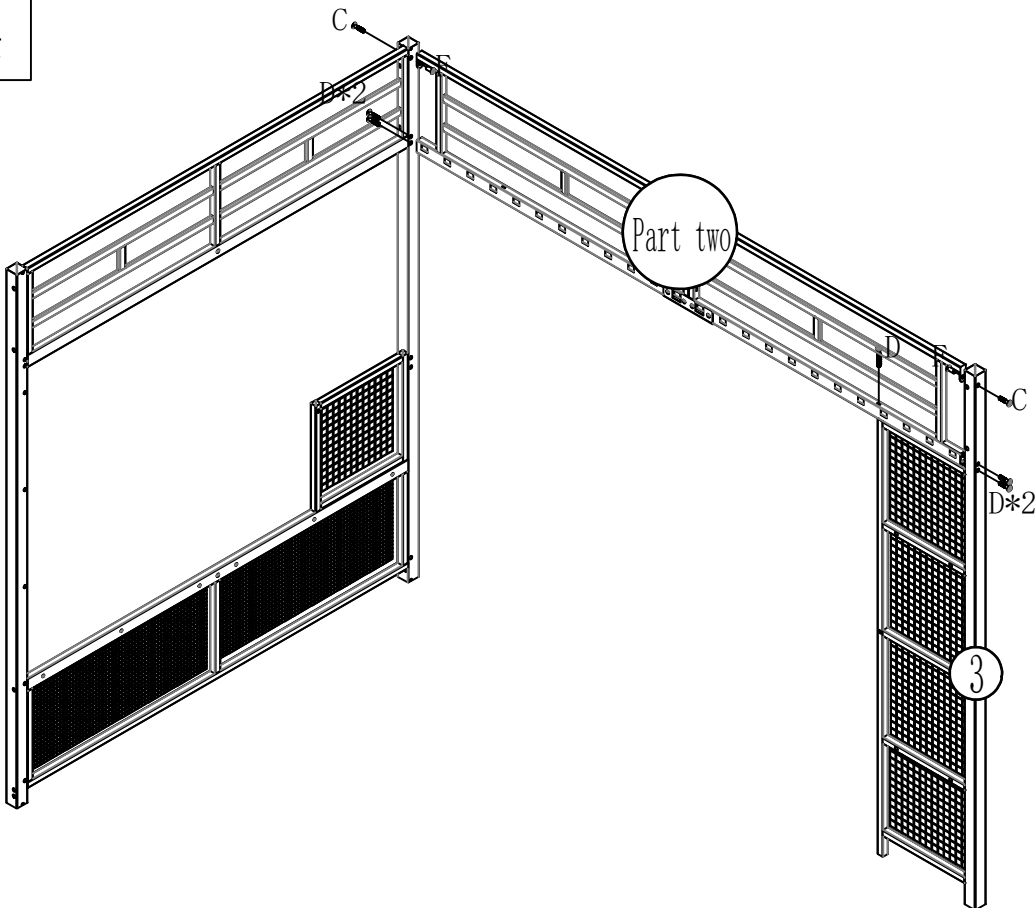

L



M8\*55mm

D × 5PCS



M8\*35mm

C × 2PCS



M8\*15mm

F × 2PCS

5

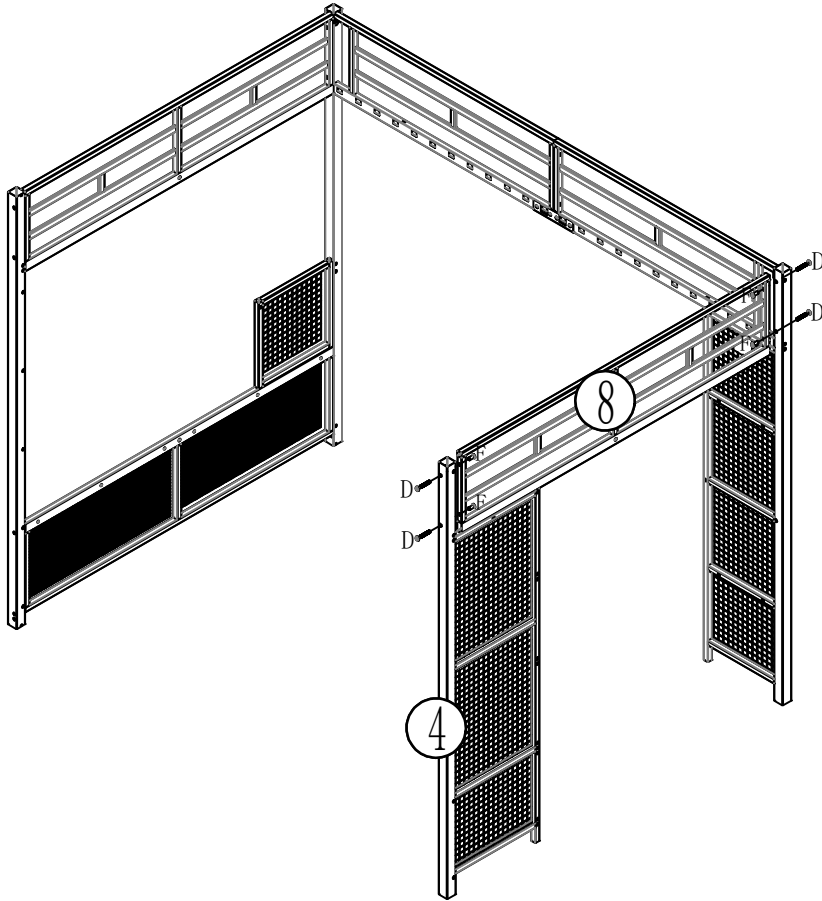

L



M8\*55mm

D × 4PCS



M8\*15mm

F × 4PCS

6

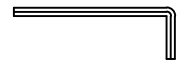
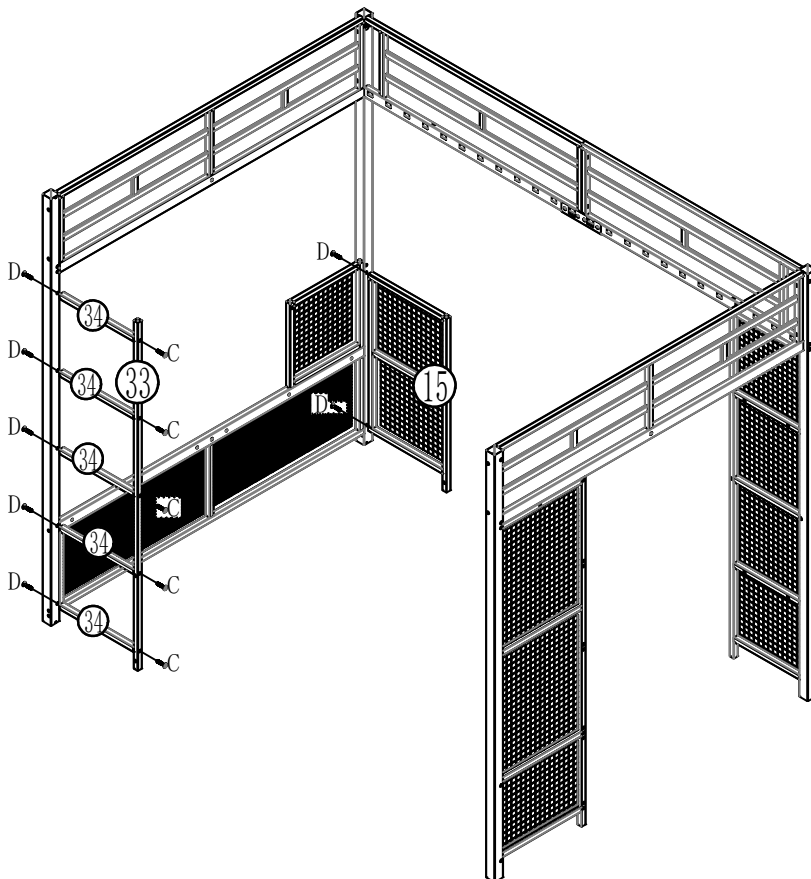

L



M8\*55mm

D × 7PCS



M8\*35mm

C × 5PCS

7

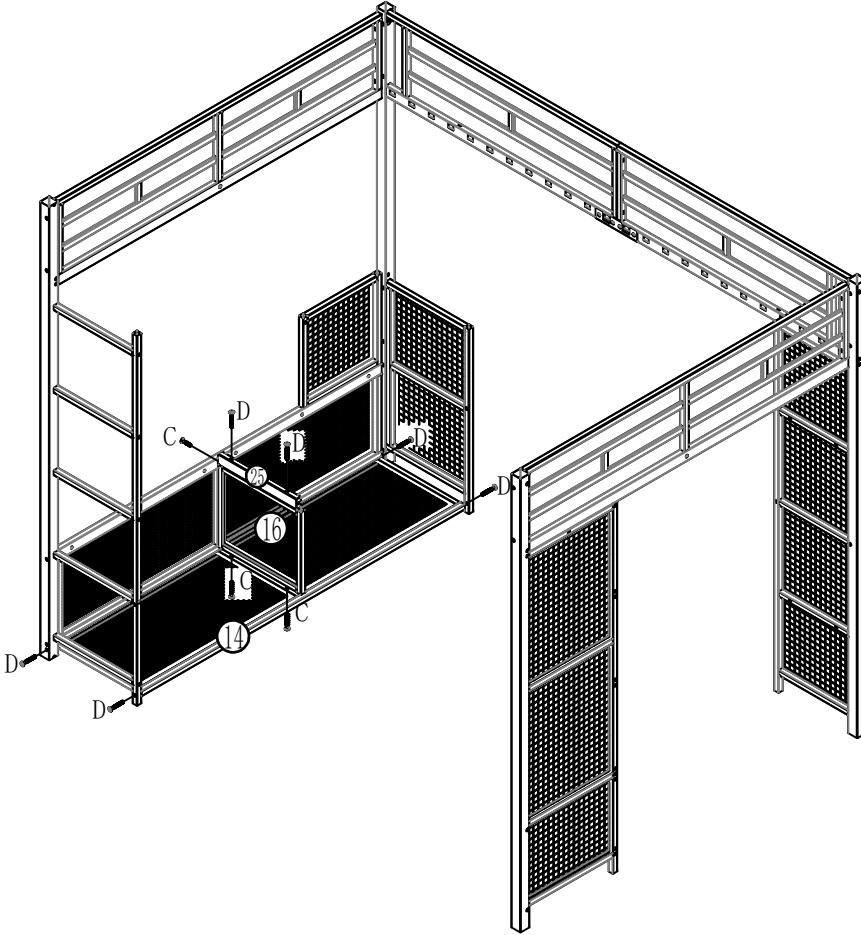

L



M8\*55mm

D × 6PCS



M8\*35mm

C × 3PCS

8

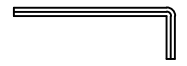
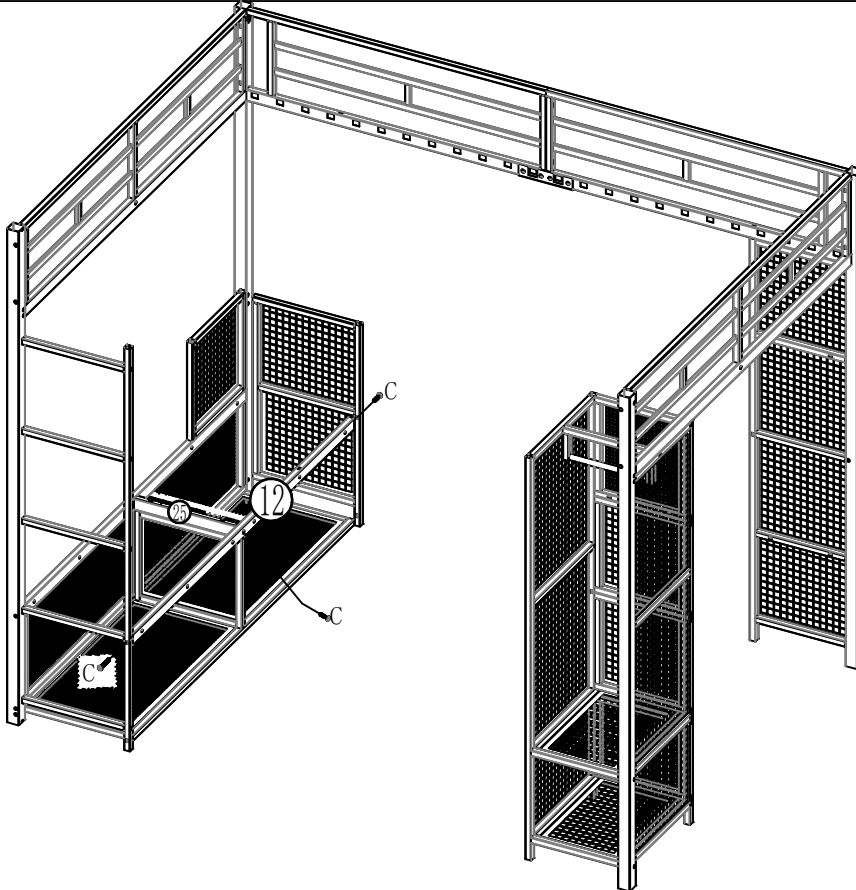

L



M8\*35mm

C × 3PCS

9

X2

First, fix No. 28 and No. 36 together. Repeat this step twice.

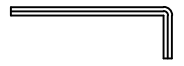
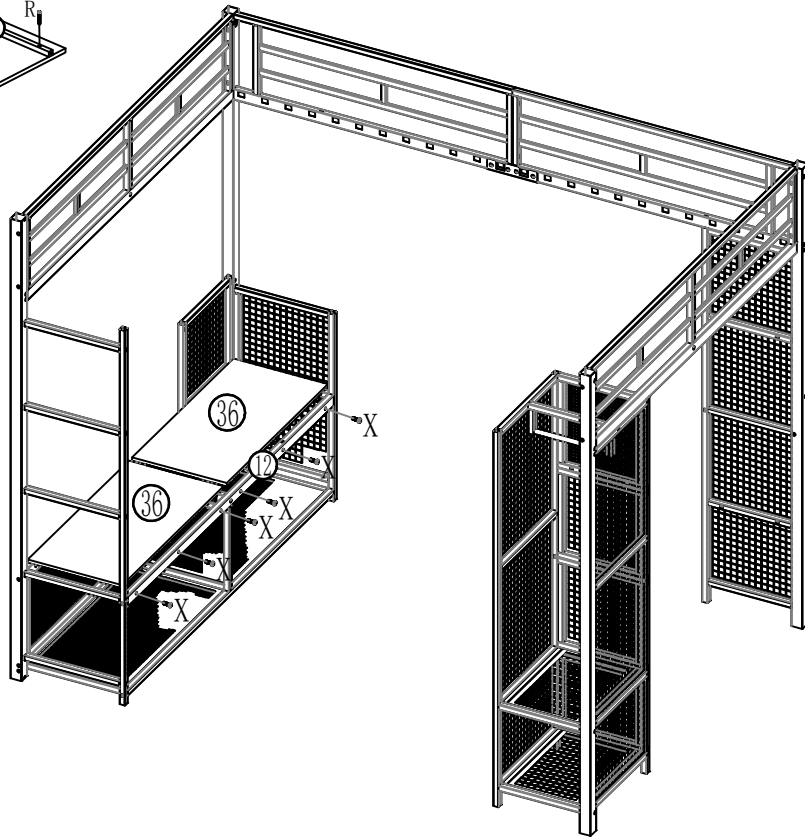
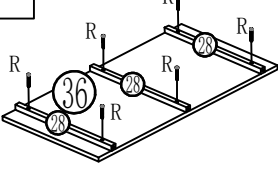

L

M4\*25mm

R × 12PCS



M6\*30mm

X × 6PCS

10

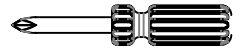
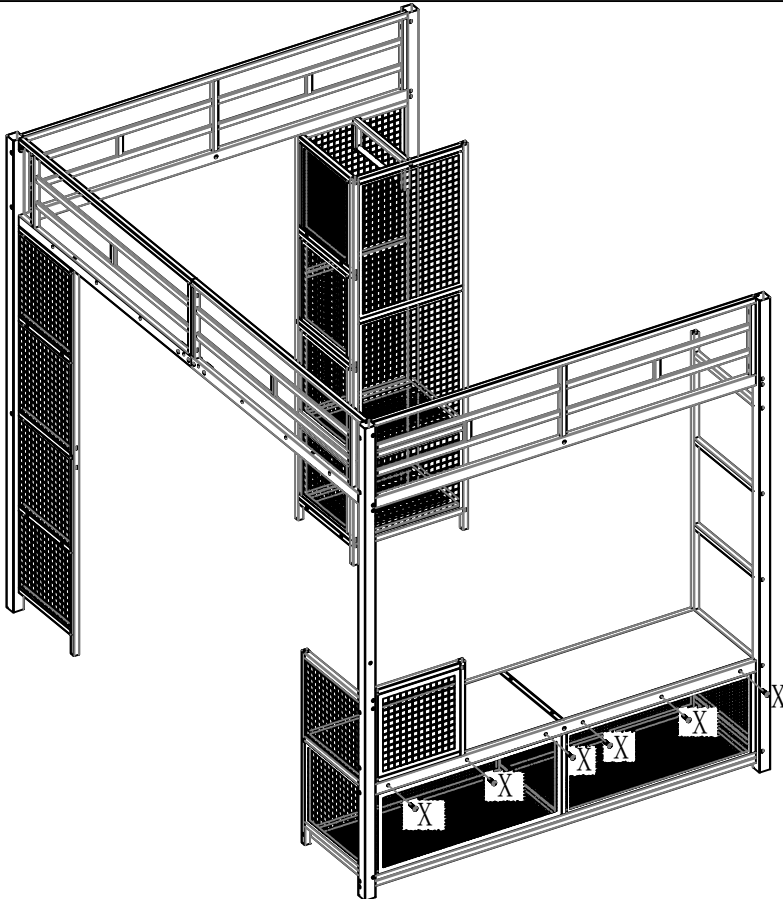

M

M6\*30mm

X × 6PCS

11

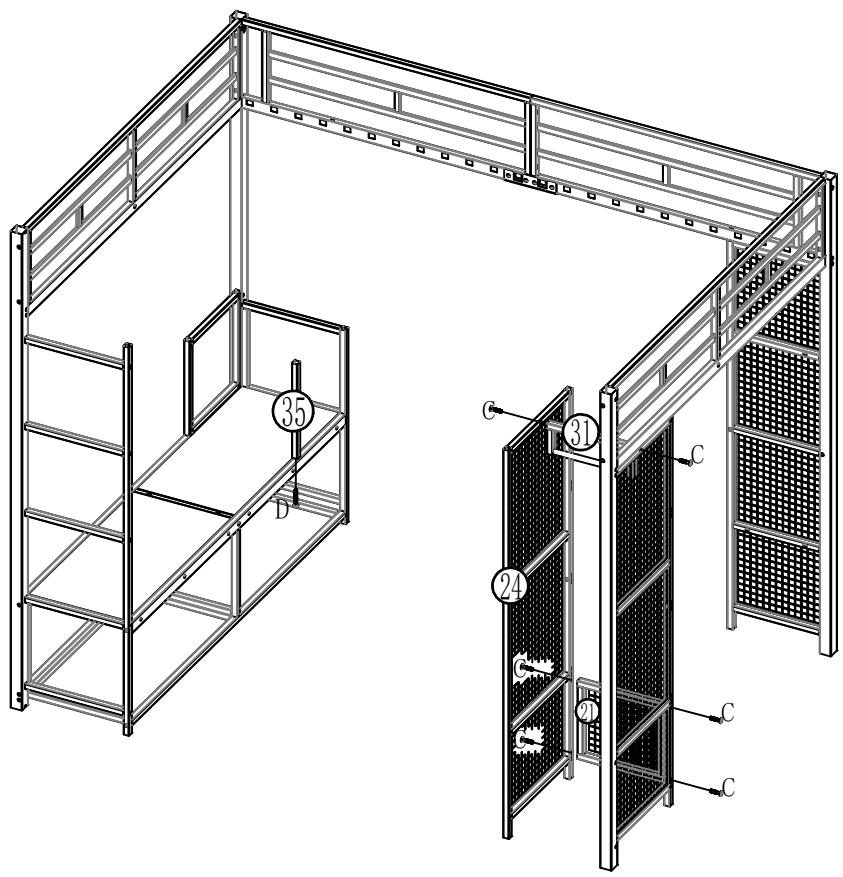

L

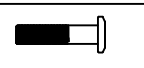

M8\*35mm

C×6PCS



M8\*55mm

D×1PCS

12

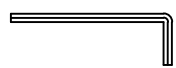
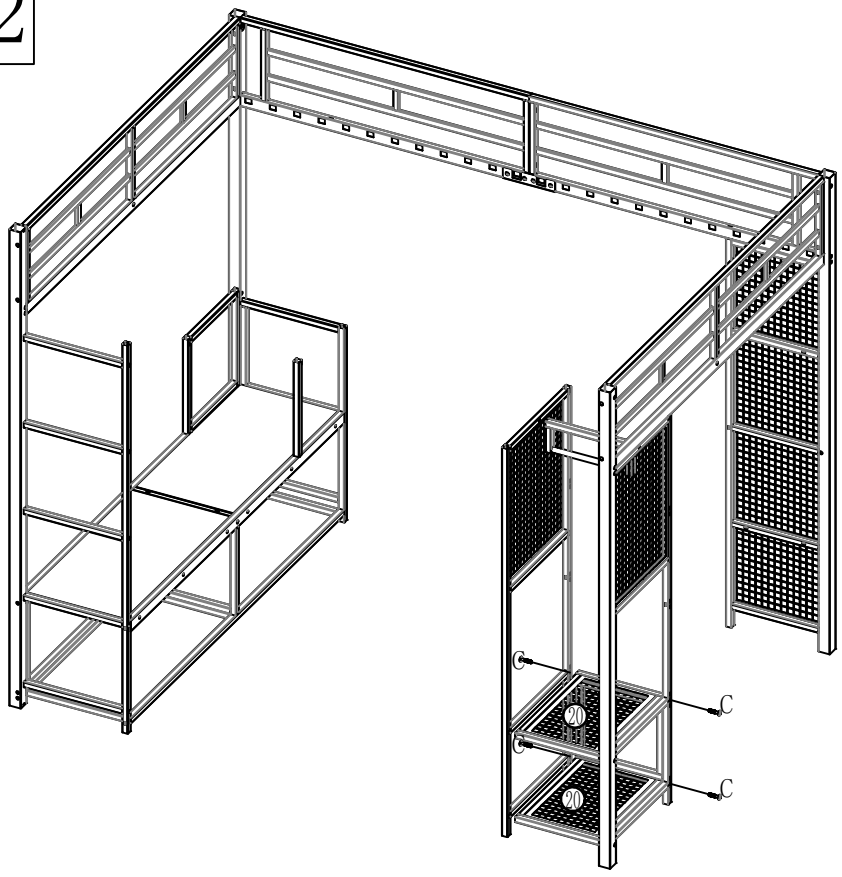

L

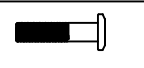

M8\*35mm

C×4PCS

13

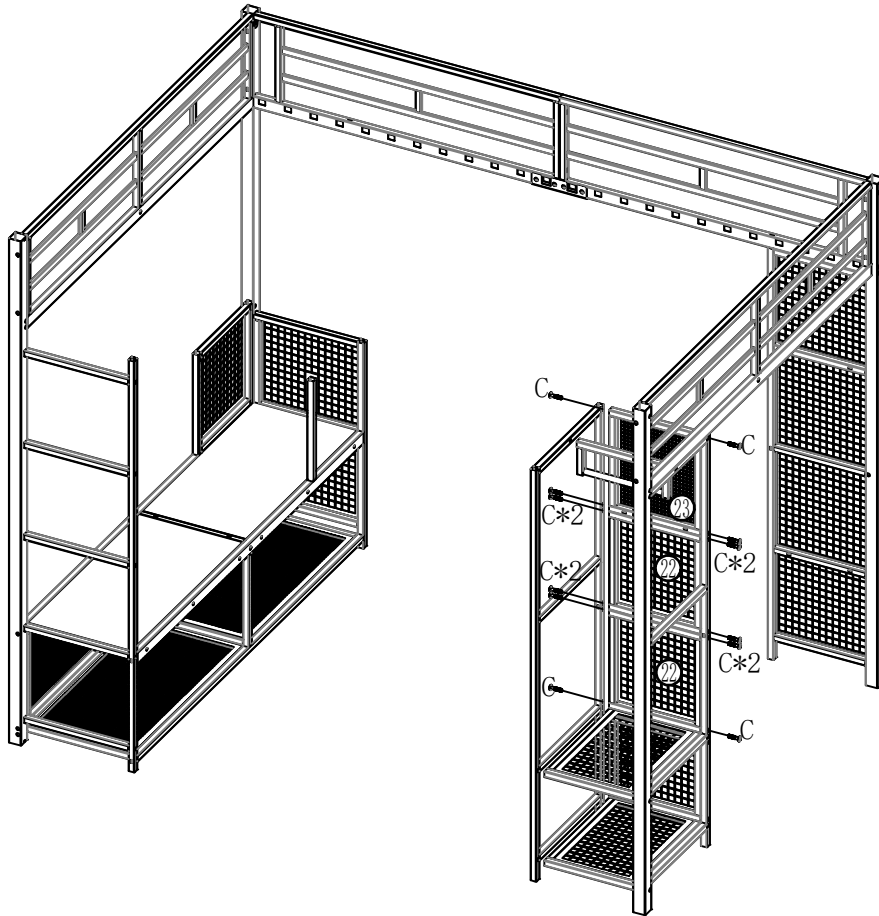

L



M8\*35mm

C × 12PCS

14

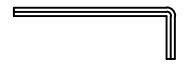
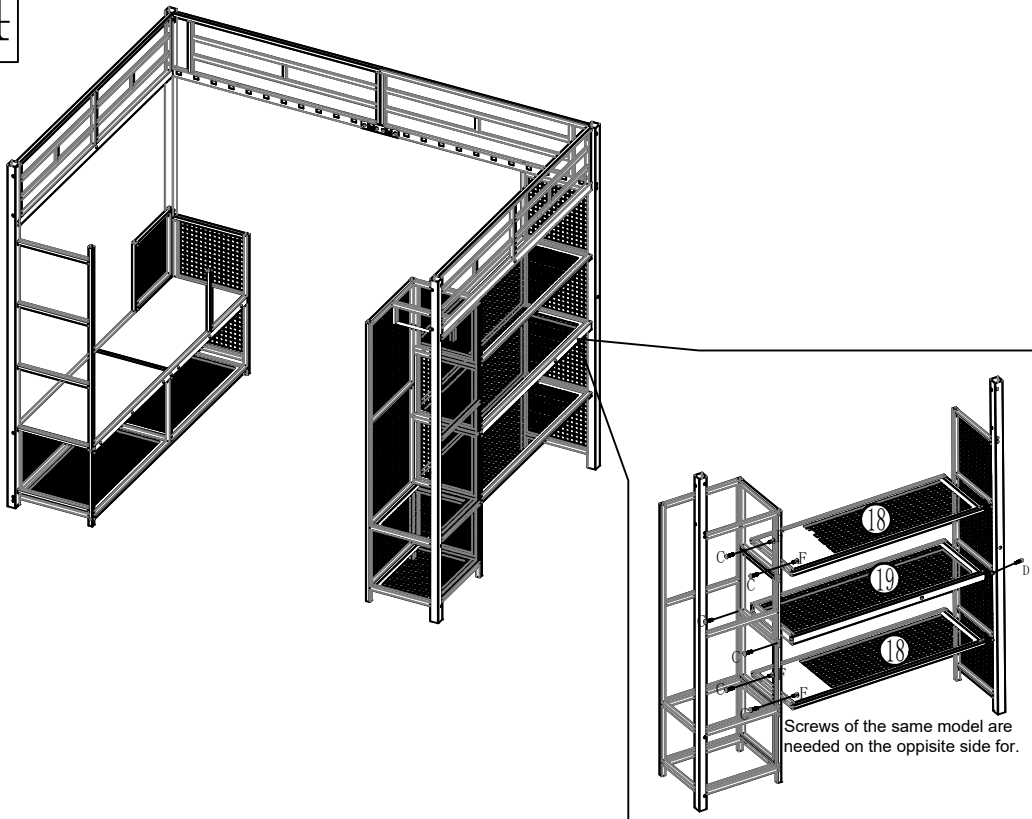

L



M8\*35mm

C × 11PCS



M8\*55mm

D × 1PCS



M8\*15mm

F × 8PCS

Screws of the same model are needed on the opposite side for.

15

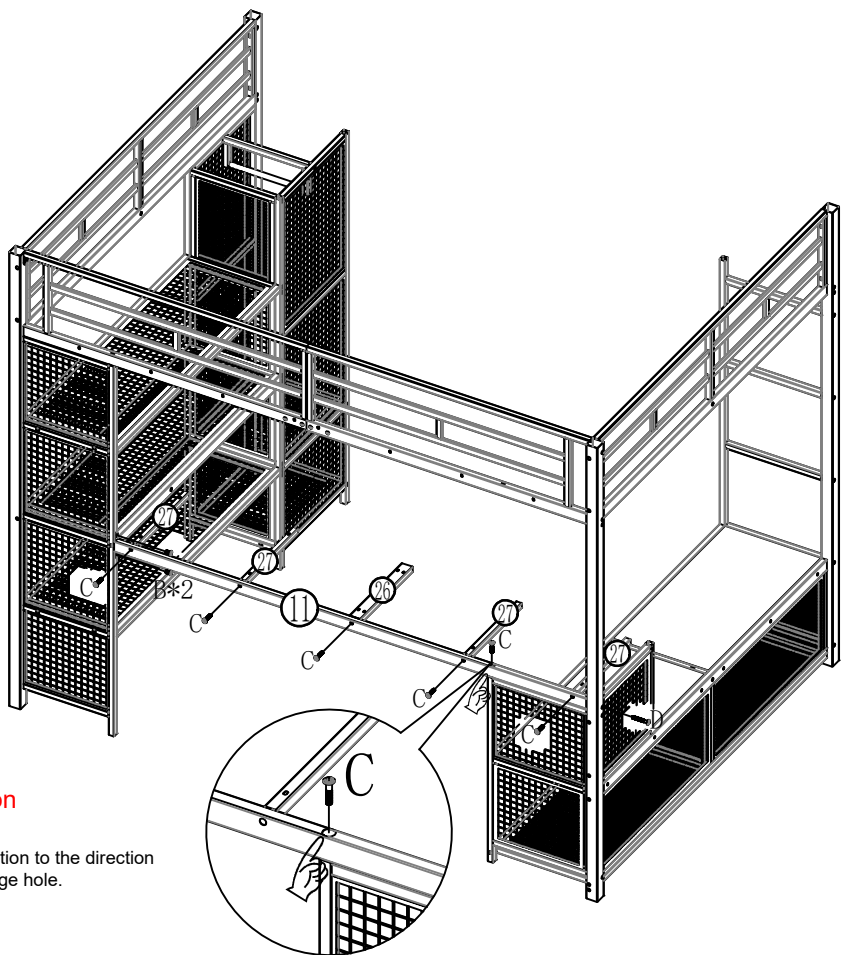

Attention

Pay attention to the direction of this large hole.

L
M8*35mm
C × 6PCS
M8*55mm
D × 1PCS
M8*15mm
B × 2PCS

16

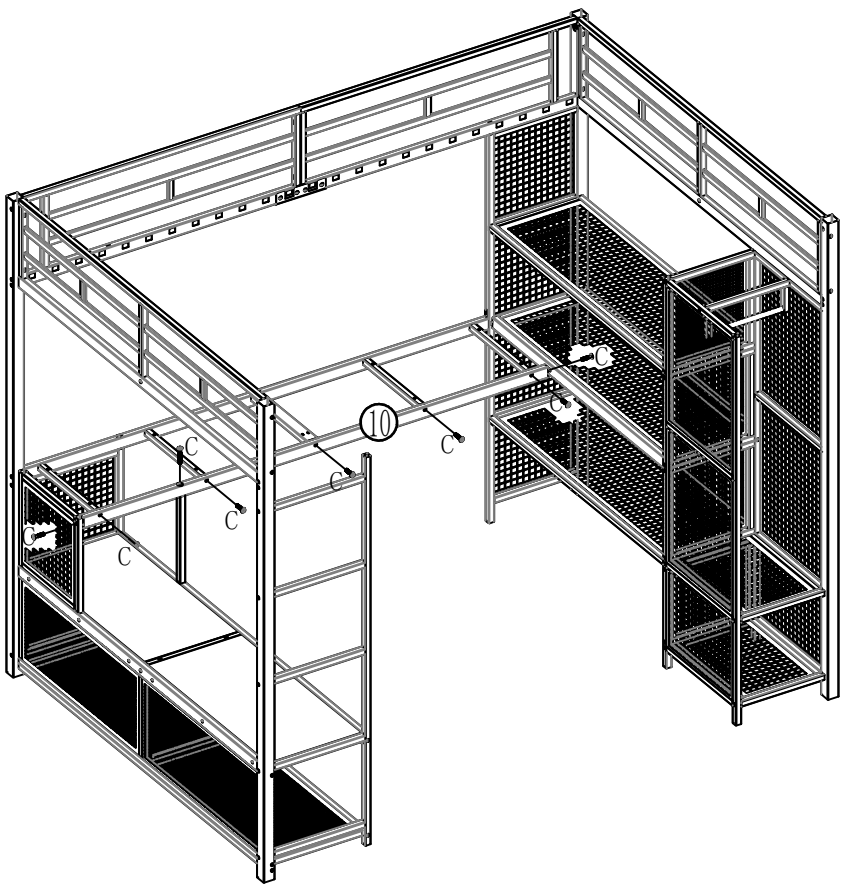

L
M8*35mm
C × 8PCS

17

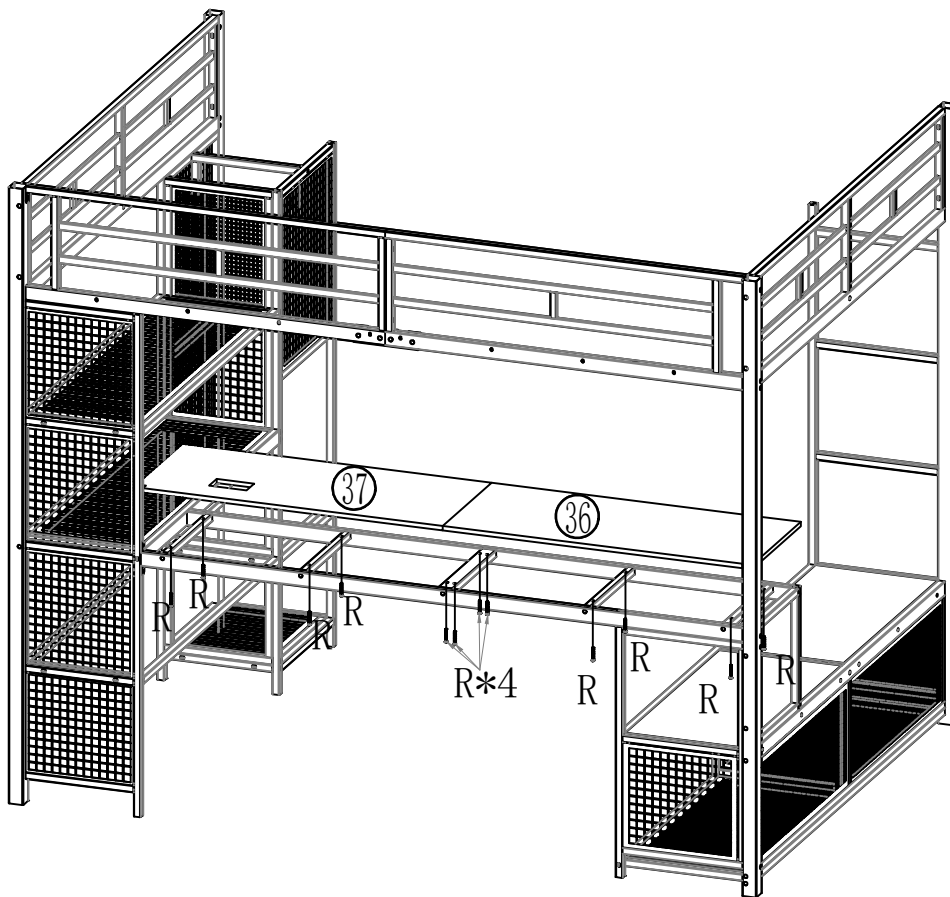

M



M4\*25mm

R × 12PCS

18

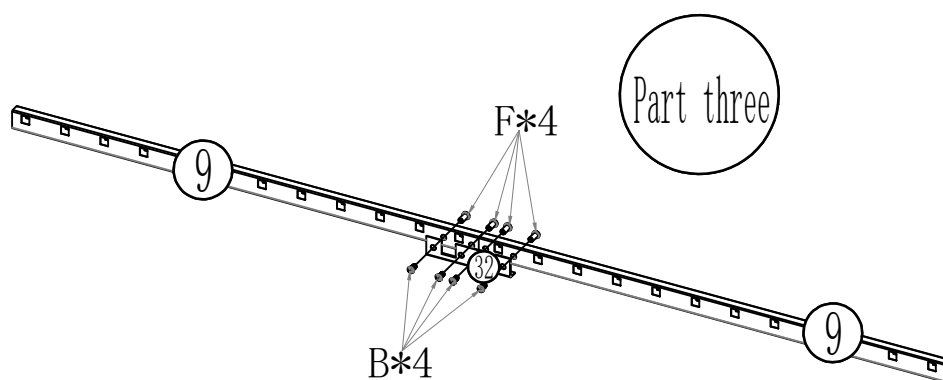

L



M8\*15mm

B × 4PCS



M8\*15mm

F × 4PCS

19

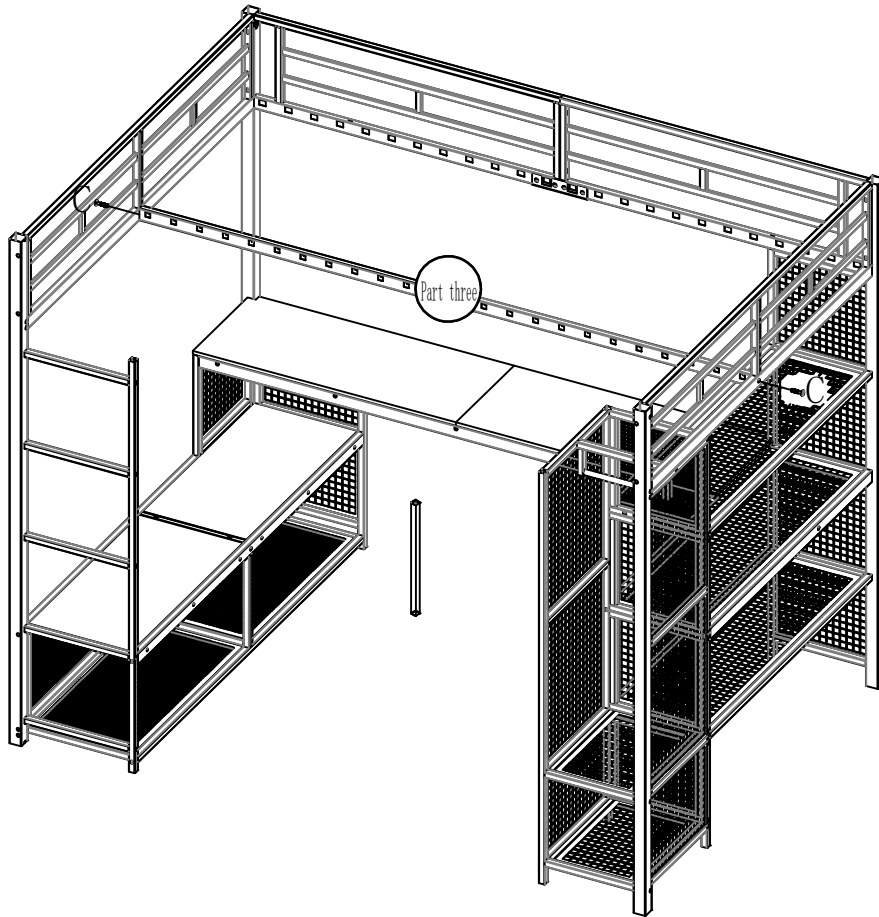

L



M8\*35mm

C × 2PCS

20

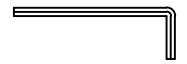
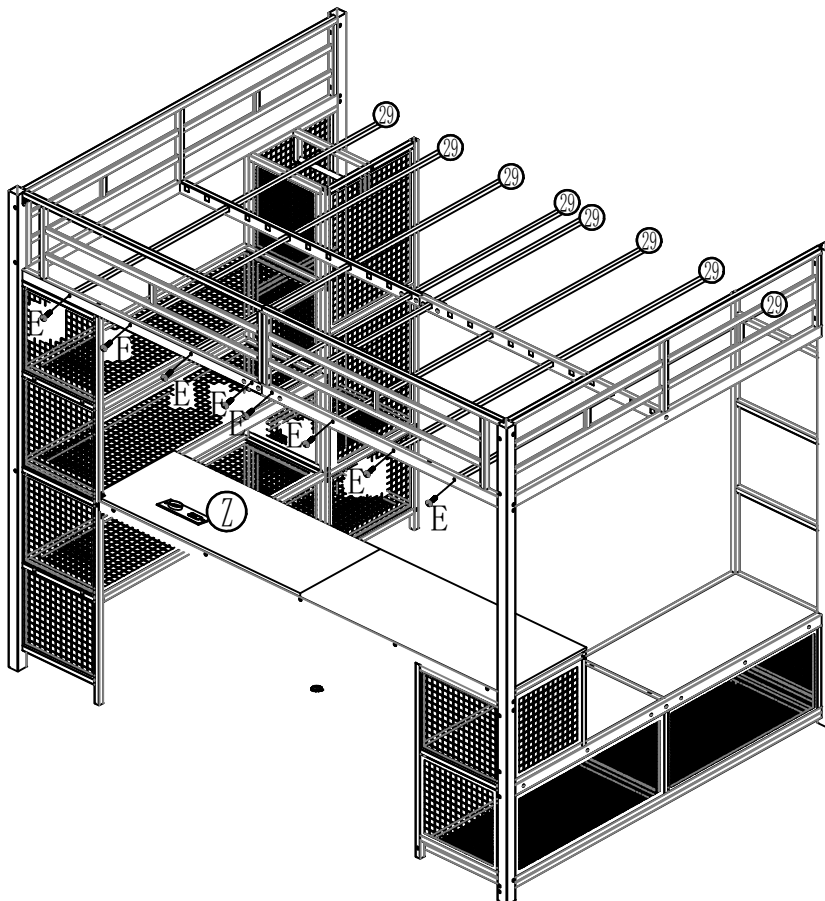

L



M6\*25mm

E × 8PCS

21

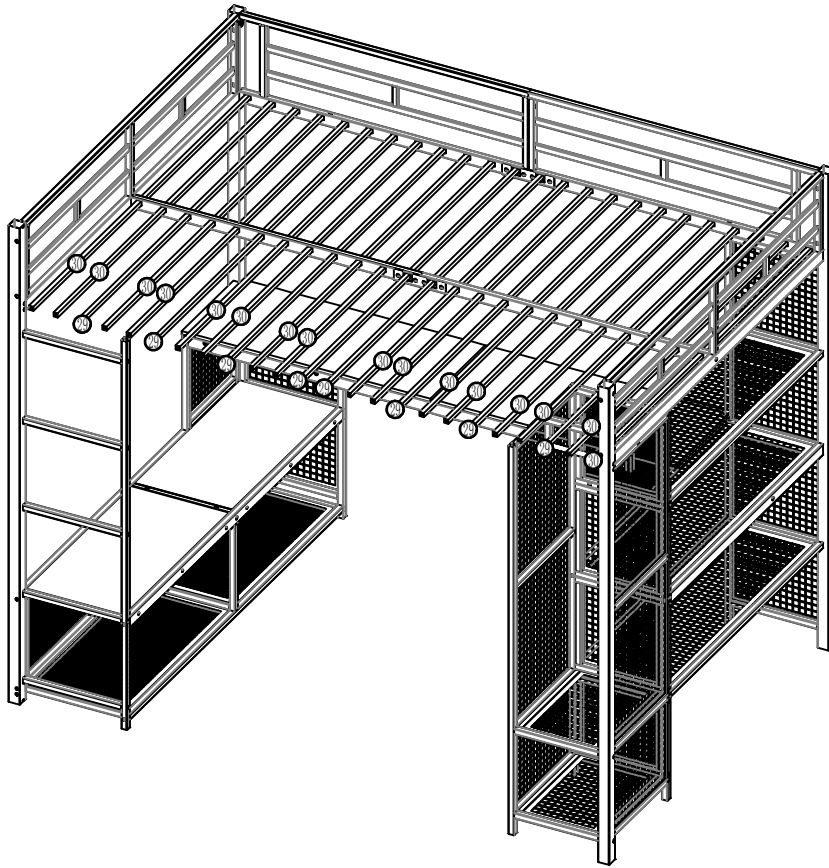

22

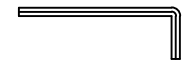
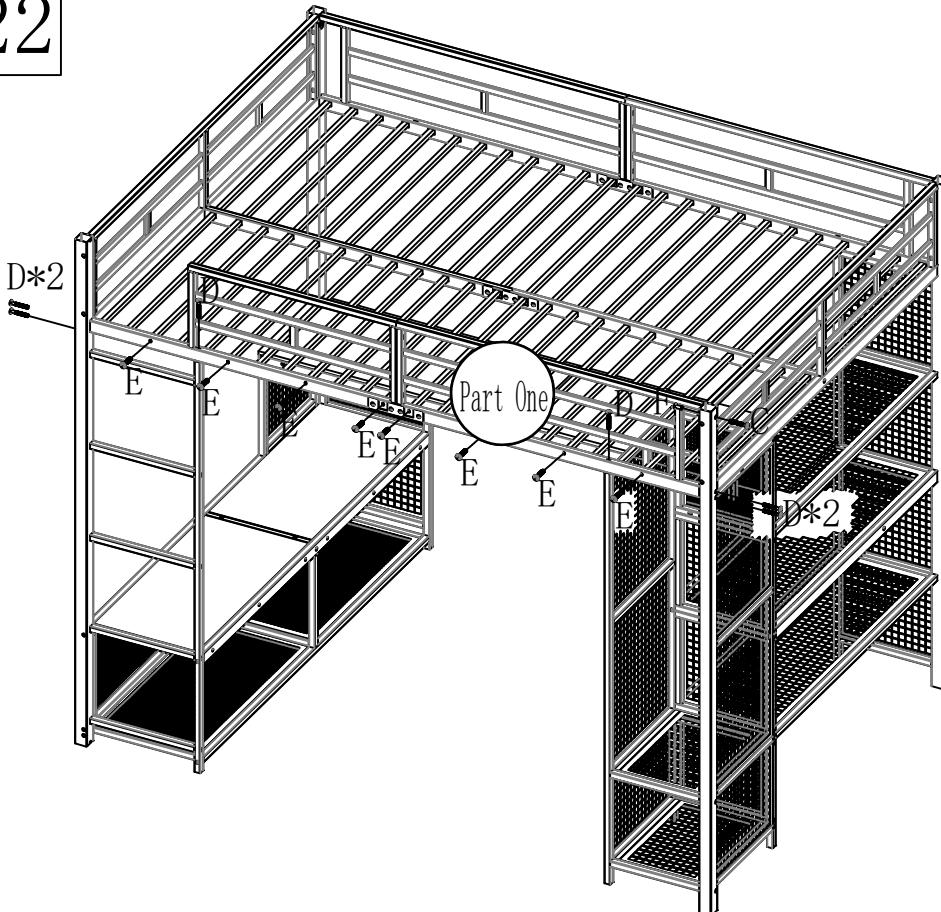

L



M6\*25mm

E × 8PCS



M8\*35mm

C × 2PCS







M8\*15mm

F × 2PCS

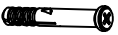

M8\*55mm

D × 1PCS

	
M	Q × 1PCS
	Y × 2PCS
	S × 2PCS
	Z × 1PCS
	A × 2PCS

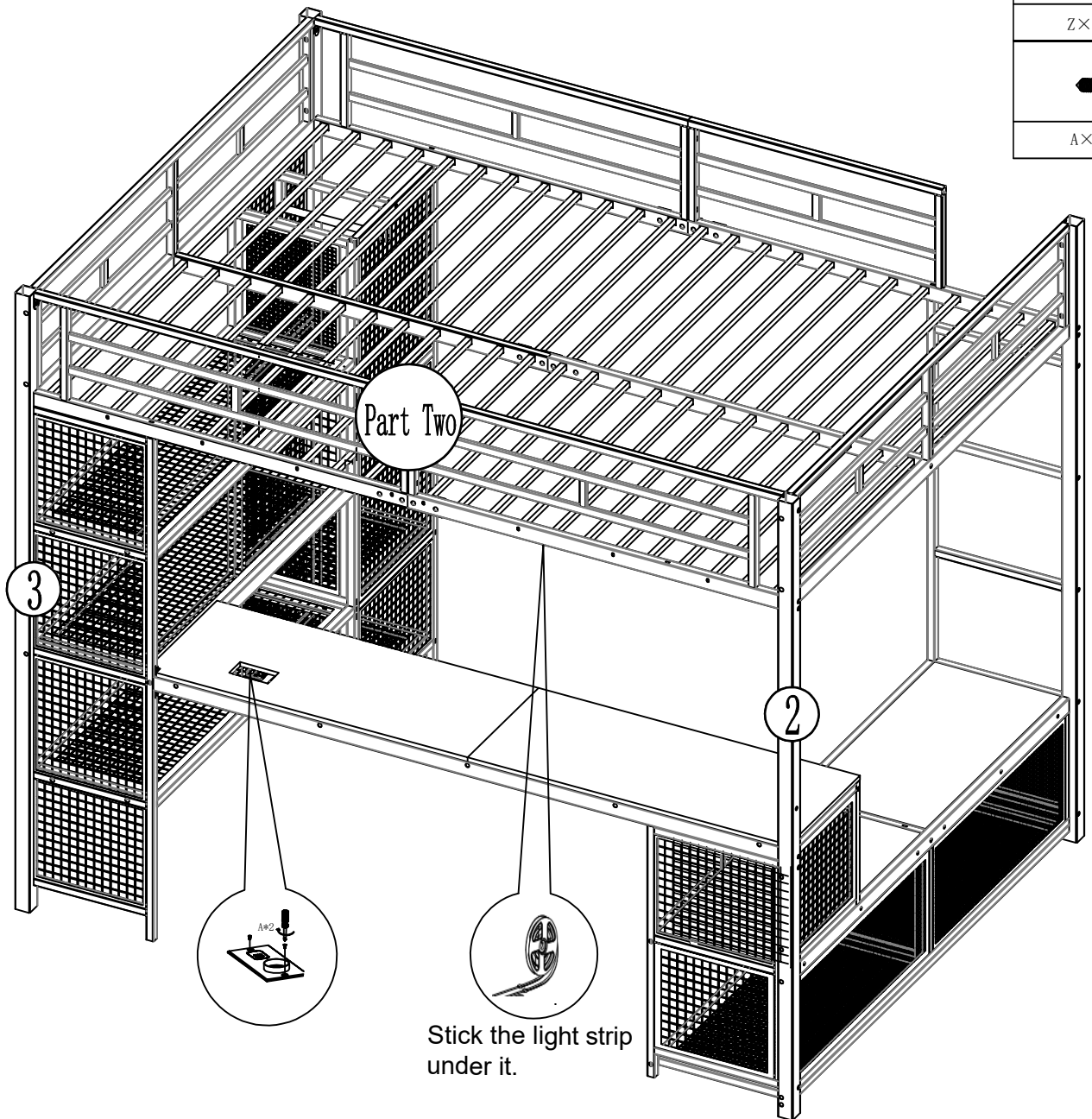

  
**Attention**

Finally, please use accessories Y and T to fix side 2 AND 3 onto the.

24

## Completed bed

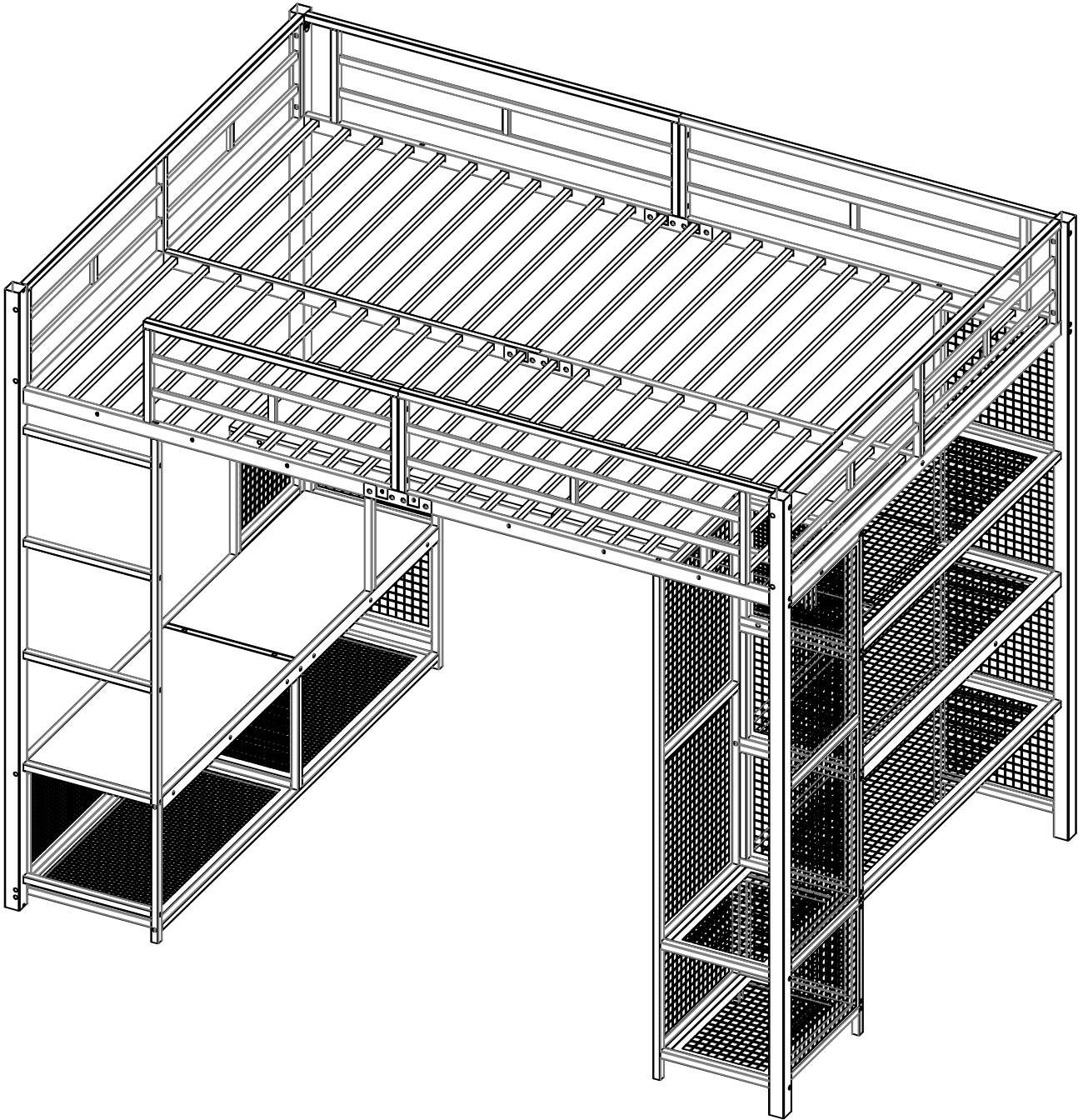

*Please make sure all bolts are fastened before use, thank you.*



# Shenzhen GUOREN Certification Technology Service Co.,Ltd.

## Declaration of LVD Conformity

Certification number: GRCTC241204027

In accordance with the following Applicable Directives:

**2014/35/EU**

Applicant: Shenzhen Chengjie Lighting Co., Ltd  
 Address: B502 Bay Area Digital Warehouse, Taoyuan Community, Dalang Street, Longhua District, Shenzhen City  
 Manufacturer: Shenzhen Chengjie Lighting Co., Ltd  
 Address: B502 Bay Area Digital Warehouse, Taoyuan Community, Dalang Street, Longhua District, Shenzhen City  
 Product: neon lamp  
 Model: 5050

Laboratory: Shenzhen GUOREN Certification Technology Service Co., Ltd.  
 101#, Building K & Building T, The Second Industrial Zone, Jiazitang Community, Fenghuang Street, Guangming District, Shenzhen, China  
 Tel: 0755-23408306 Fax: 0755-23408309  
 http://www.grcert.com E-mail: grct\_sa@grcert.com

The test sample of product has been passed, the test according to requirements of the following standards:

Standard(s):	Test report(s) No.:
EN 60598-2-20:2015 used in conjunction with EN IEC 60598-1:2021 + A11:2022	GRCTR241204027

The certification is only valid for the equipment and configuration described in conjunction with the test data detailed above. The CE mark as shown beside can be used, under the responsibility of the manufacturer, after completion of an EC Directive of Conformity and compliance with all relevant EC Directive.



Approved by:

Department Manager

Date: Jan. 06, 2025





The certificate is responsible for testing sample only.  
Please refer to this corresponding test report to get testing process and data.

# CERTIFICATE

## ATTESTATION Certificate of Compliance

Technical file of the company mentioned below has been inspected and audit has been completed successfully

The Low Voltage Directive 2014/35/EU has been taken as references for these processes.

Certificate's Holder : QingDao ChengKong Electrical-Auto Co., Ltd.

Address : Room 5-402, No.147 Xining Road, Zhuhai Community, Huangdao District, Qingdao, Shandong, China

Manufacturer : QingDao ChengKong Electrical-Auto Co., Ltd.

Address : Room 5-402, No.147 Xining Road, Zhuhai Community, Huangdao District, Qingdao, Shandong, China

Product Name : Furniture Power Distribution Unit

Product Model (S) : JN02-00-22, JN02-00-22Y, JN02-00-02, JN02-00-21, JN02-00-23, JN02-00-03, JN02-00-04

Trade Mark : Roozmausy

Related Directive : 2014/35/EU

Related Standards : EN IEC 62368-1:2020 + A11:2020

Certificate Number : HK2405271322S

Report No. : HK2405271322-SR

Registration Date : Jun. 04, 2024



Certificate Manager



The information of the certificate can be checked through [www.cer-mark.com](http://www.cer-mark.com). The CE mark which is shown on the certificate can only be used under the conditions that the products comply with all of the relevant Directives of CE Declaration of Conformity. The Manufacturer should be responsible for the internal production control so that the products comply with the essential requirements of the above mentioned Directive(s). Certificate holder must notify all changes to the original certification laboratory of HUAKE.



Shenzhen HUAKE Testing Technology Co., Ltd.

Add: 1-2/F, Building B2, Jindong Zhongyuan Zhongyuan Innovation Park, Huanggang, Futian District, Shenzhen, Guangdong, China  
Tel: +86-755-23021001 | HTTP: www.cer-mark.com | Postcode: 518103 | E-mail: service@cer-mark.com